

EVoplus⁺ V2.0

SMALL

ISTRUZIONI PER L'INSTALLAZIONE E LA MANUTENZIONE
INSTRUCTIONS FOR INSTALLATION AND MAINTENANCE
INSTRUCCIONES PARA LA INSTALACIÓN Y EL MANTENIMIENTO
INSTALLATIONS - OCH UNDERHÅLLSANVISNING
INSTRUCTIONS POUR L'INSTALLATION ET LA MAINTENANCE
INSTRUCTIES VOOR INGEBRIJKNAMEN EN ONDERHOUD
INSTRUCTIUNI DE INSTALARE SI INTRETINERE
INSTALLATIONSANWEISUNG UND WARTUNG
INSTRUKCJA MONTAŻU I KONSERWACJI
ΟΔΗΓΙΕΣ ΓΙΑ ΤΗΝ ΕΓΚΑΤΑΣΤΑΣΗ ΚΑΙ ΤΗ ΣΥΝΤΗΡΗΣΗ
NÁVOD NA POUŽITÍ A ÚDRŽBU
NÁVOD NA INŠTALÁCIU A ÚDRŽBU
MONTAJ VE BAKIM İÇİN BİLGİLER
UZSTĀDĪŠANAS UN TEHNISKĀS APKOPES ROKASGRĀMATA
MONTAVIMO IR TECHININĖS PRIEŽIŪROS INSTRUKCIJOS
INSTRUÇÕES PARA A INSTALAÇÃO
РУКОВОДСТВО ПО МОНТАЖУ И ТЕХНИЧЕСКОМУ ОБСЛУЖИВАНИЮ
ASENNUS- JA HUOLTO-OHJEET
NAVODILA ZA VGRADNJO IN UPORABO
ИНСТРУКЦІЯ ЗА ІНСТАЛІРАЦІЮ І ОБСЛУЖВАННЯ
HASZNÁLATI ÚTMUTATÓ A BEÁLLÍTÁSHOZ ÉS KARBANTARTÁSHOZ
КЕРІВНИЦТВО З МОНТАЖУ ТА ТЕХНІЧНОГО ОБСЛУГОВУВАННЯ

40/180 M 60/180 M 80/180 M 110/180 M	40/180 SAN M 60/180 SAN M 80/180 SAN M 110/180 SAN M	
40/180 XM 60/180 XM 80/180 XM 110/180 XM		
B 40/220.32 M B 60/220.32 M B 80/220.32 M B 110/220.32 M	B 40/220.32 SAN M B 60/220.32 SAN M B 80/220.32 SAN M B 110/220.32 SAN M	D 40/220.32 M D 60/220.32 M D 80/220.32 M D 110/220.32 M
B 40/250.40 M B 60/250.40 M B 80/250.40 M B 110/250.40 M	B 40/250.40 SAN M B 60/250.40 SAN M B 80/250.40 SAN M B 110/250.40 SAN M	D 40/250.40 M D 60/250.40 M D 80/250.40 M D 110/250.40 M

ITALIANO	pag.	01
ENGLISH	page	08
ESPAÑOL	pág	15
SVENSKA	sid	22
FRANÇAIS	page	30
NEDERLANDS	bladz	36
ROMANA	pag.	43
DEUTSCH	Seite	50
POLSKI	strona	57
ΕΛΛΗΝΙΚΑ	Σελίδα	64
ČESKY	strana	71
SLOVENSKÝ JAZYK	str.	78
TÜRKÇE	say	85
LATVIEŠU	lpp.	92
LIETUVIŠKAI	psl.	99
PORTUGUÊS	pág	106
РУССКИЙ	стр.	113
SUOMI	sivu	120
SLOVENŠČINA	str.	127
БЪЛГАРСКИ	Стр.	134
MAGYAR	Old.	141
УКРАЇНСЬКА	стр.	148

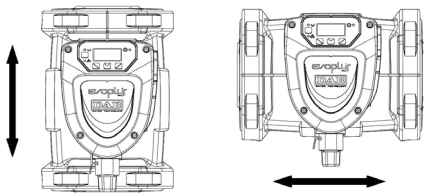

Figure 1: Assembly position

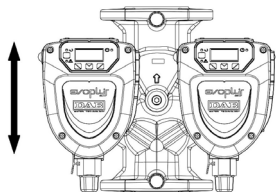

Figure 2: Installation on horizontal pipes

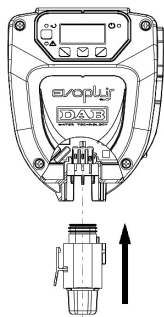

Figure 4: Power supply connector connection

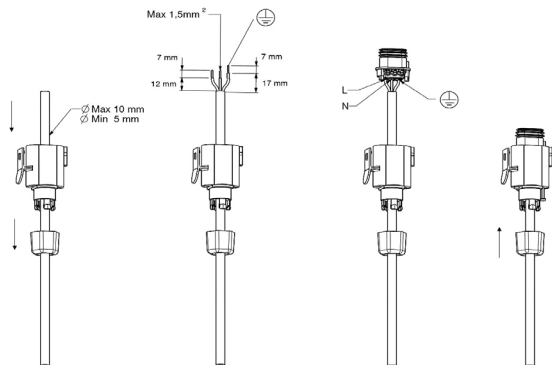

Figure 3: Power supply connector wiring

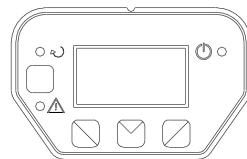

Figure 5: Control panel

EVOPLUS SMALL	Hmax [m]	Qmax [m3/h]	EVOPLUS SMALL	Hmax [m]	Qmax [m3/h]
40/180 M - 40/180 SAN M*	4,0	6,0			
60/180 M - 60/180 SAN M*	6,0	7,0			
80/180 M - 80/180 SAN M*	8,0	8,0			
110/180 M - 110/180 SAN M*	11,0	9,0			
40/180 XM	4,0	6,0			
60/180 XM	6,0	7,2			
80/180 XM	8,0	8,2			
110/180 XM	11,0	10,0			
B 40/220.32 M - B 40/220.32 SAN M*	4,0	7,4	D 40/220.32 M	4,0	7,0
B 60/220.32 M - B 60/220.32 SAN M*	6,0	9,0	D 60/220.32 M	6,0	8,0
B 80/220.32 M - B 80/220.32 SAN M*	8,0	10,0	D 80/220.32 M	8,0	9,0
B 110/220.32 M - B 110/220.32 SAN M*	11,0	11,0	D 110/220.32 M	11,0	10,0
B 40/250.40 M - B 40/250.40 SAN M*	4,0	8,4	D 40/250.40 M	4,0	8,0
B 60/250.40 M - B 60/250.40 SAN M*	6,0	9,8	D 60/250.40 M	6,0	9,0
B 80/250.40 M - B 80/250.40 SAN M*	8,0	10,8	D 80/250.40 M	8,0	10,0
B 110/250.40 M - B 110/250.40 SAN M*	11,0	12,0	D 110/250.40 M	11,0	11,2

*This circulator is suitable for drinking water only.

Table: Maximum head (Hmax) and maximum flow rate (Qmax) of EVOPLUS SMALL circulators

Energy Efficiency Index - EEI	
EVOPLUS 40/180 M	0,23
EVOPLUS 60/180 M	0,22
EVOPLUS 80/180 M	0,22
EVOPLUS 110/180 M	0,22
EVOPLUS 40/180 XM	0,21
EVOPLUS 60/180 XM	0,21
EVOPLUS 80/180 XM	0,21
EVOPLUS 110/180 XM	0,21
EVOPLUS B 40/220.32 M	0,22
EVOPLUS B 60/220.32 M	0,22
EVOPLUS B 80/220.32 M	0,22
EVOPLUS B 110/220.32 M	0,22
EVOPLUS B 40/250.40 M	0,21
EVOPLUS B 60/250.40 M	0,21
EVOPLUS B 80/250.40 M	0,21
EVOPLUS B 110/250.40 M	0,21
EVOPLUS D 40/220.32 M	0,23
EVOPLUS D 60/220.32 M	0,23
EVOPLUS D 80/220.32 M	0,23
EVOPLUS D 110/220.32 M	0,23
EVOPLUS D 40/250.40 M	0,22
EVOPLUS D 60/250.40 M	0,22
EVOPLUS D 80/250.40 M	0,22
EVOPLUS D 110/250.40 M	0,22

The benchmark for the most efficient circulators is $EEI \leq 0,20$.

INDEX

1. Particular warnings	9
2. Pumped liquids	9
3. Electromagnetic Compatibility (EMC)	9
4. Management	9
4.1 Storage	9
4.2 Transport	9
4.3 Weight	9
5. Installation	9
5.1 Circular Installation and Maintenance	9
5.2 Rotation of the Motor Heads	10
5.3 Non-return valve	10
6. Electrical connections	10
6.1 Power supply connection	10
7. Start	10
8. Functions	10
8.1 Regulating Modes	10
8.1.1 Regulation with Proportional Differential Pressure	10
8.1.2 Regulation with Constant Differential Pressure	11
8.1.3 Regulation with constant curve	11
8.2 Expansion Modules	11
9. Control Panel	11
9.1 Graphic Display	11
9.2 Navigation Buttons	11
9.3 Warning Lights	11
10. Menus	11
11. Factory settings	13
12. TypeS of Alarm	13
13. Error Condition And Reset	13

INDEX OF FIGURES

Figure 1: Assembly position	1A
Figure 2: Installation on horizontal pipes	1A
Figure 3: Power supply connector wiring	1A
Figure 4: Power supply connector connection	1A
Figure 5: Control panel	1A

INDEX OF TABLES

Table 1: Factory settings	13
Table 2: List of alarms	13

Table: Maximum head (Hmax) and maximum flow rate (Qmax) of EVOPLUS SMALL circulators	2A
---	----

Table: Energy Efficiency Index - EEI	3A
---	----

1. PARTICULAR WARNINGS



Ensure that the product has not suffered any damage during transport or storage. Check that the outer casing is unbroken and in excellent conditions.



Always switch off the mains power supply before working on the electrical or mechanical part of the system. Wait for the warning lights on the control panel to go out before opening the appliance. The capacitor of the direct current intermediate circuit remains charged with dangerously high voltage even after the mains power has been turned off.

Only firmly cabled mains connections are admissible. The appliance must be earthed (IEC 536 class 1, NEC and other applicable standards). Mains terminals and motor terminals may still have dangerous voltage when the motor is stopped.



If the power cable is damaged, it must be replaced by the technical assistance service or by qualified personnel, so as to avoid any risk.



2. PUMPED LIQUIDS

The machine has been designed and made for pumping water, free from explosive substances and solid particles or fibres, with a density of 1000 Kg/m³, a kinematic viscosity of 1mm²/s and non chemically aggressive liquids. It is possible to use ethylene glycol in a percentage of no more than 30%.

3. ELECTROMAGNETIC COMPATIBILITY (EMC)

EVOPLUS SMALL circulators respect standard EN 61800-3, in the C2 category, for electromagnetic compatibility.

- Electromagnetic emissions - Industrial environment (in some cases restrictive measures may be requested).
- Conducted emissions - Industrial environment (in some cases restrictive measures may be requested).

4. MANAGEMENT

4.1 Storage

All the circulators must be stored in a dry covered place, with possibly constant air humidity, free from vibrations and dust. They are supplied in their original pack in which they must remain until the time of installation. If this is not the case, accurately close the suction and delivery mouth.

4.2 Transport

Avoid subjecting the products to needless impacts and collisions. To lift and transport the circulator use lifting devices with the aid of the pallet supplied with it (if contemplated).

4.3 Weight

The adhesive plate on the packaging indicates the total weight of the circulator.

5. INSTALLATION

Carefully follow the advice in this chapter to carry out correct electrical, hydraulic and mechanical installation.



Ensure that the voltage and frequency on the data plate of the EVOPLUS SMALL circulator are the same as those of the power mains.

5.1 Circular Installation and Maintenance



Always install the EVOPLUS SMALL circulator with the motor shaft in a horizontal position. Install the electronic control device in a vertical position (see Figure 1)

- The circulator may be installed in heating and conditioning systems on either the delivery pipe or the return pipe; the arrow marked on the pump body indicates the direction of flow.
- Install the circulator as far as possible above the minimum boiler level and as far as possible from bends, elbows and junction boxes.
- To facilitate control and maintenance operations, install an interception valve both on the suction pipe and on the delivery pipe.
- Before installing the circulator, accurately flush the system with only water at 80°C. Then drain the system completely to eliminate any harmful substance that may have got into circulation.
- Assemble in such a way as to avoid dripping on the motor and on the electronic control device during both installation and maintenance.
- Avoid mixing additives derived from hydrocarbons and aromatic products with the circulating water. It is recommended that the addition of antifreeze, where necessary, should not exceed 30%.
- In the event of heat insulation use the special kit (if provided) and ensure that the condensate draining holes in the motor casing are not closed or partly blocked.
- To guarantee maximum efficiency of the system and long life of the circulator it is recommended to use magnetic sludge-removing filters to separate and collect any impurities present in the system (particles of sand, particles of iron and sludge).
- In the case of maintenance, always use a set of new gaskets.



Never insulate the electronic control device.

5.2 Rotation of the Motor Heads

If the circulator is installed on pipes in a horizontal position, it will be necessary to rotate the motor with the respective electronic device through 90 degrees in order to maintain the grade of IP protection and to allow the user a more convenient interaction with the graphic interface (see Figure 2).



Before rotating the circulator, ensure that it has been completely drained.

To rotate the EVOPLUS SMALL circulator, proceed as follows:

1. Remove the 4 fixing screws of the circulator head.
2. Rotate the motor casing with the electronic control device through 90 degrees clockwise or counterclockwise, as necessary.
3. Reassemble and tighten the 4 screws that fix the circulator head.



The electronic control device must always remain in vertical position!

5.3 Non-return valve

If the system is equipped with a non-return valve, ensure that the minimum pressure of the circulator is always higher than the valve closing pressure.

6. ELECTRICAL CONNECTIONS

The electrical connections must be made by expert, qualified personnel.

- The circulator does not require any external motor protection.
- Ensure that the supply voltage and frequency are the same as the values indicated on the electrical data plate of the circulator.

6.1 Power supply connection

After having wired the power supply cable as shown in Figure 3, connect it to the board as shown in Figure 4.

Before supplying power to the circulator, ensure that the cover of the EVOPLUS SMALL control panel is perfectly closed!

7. START



All the starting operations must be performed with the cover of the EVOPLUS SMALL control panel closed!

Start the system only when all the electrical and hydraulic connections have been completed.

Avoid running the circulator when there is no water in the system.



As well as being at a high temperature and pressure, the fluid in the system may also be in the form of steam. **DANGER OF SCALDING!** It is dangerous to touch the circulator. **DANGER OF SCALDING!**

Once all the electrical and hydraulic connections have been made, fill the system with water and if necessary with glycol (for the maximum glycol percentage see par. 2) and feed the system.

Once the system has been started it is possible to modify the operating modes to adapt better to the plant requirements (see par.10).

8. FUNCTIONS

8.1 Regulating Modes

EVOPLUS SMALL circulators allow the following regulating modes depending on plant requirements:

- Proportional differential pressure regulation depending on the flow present in the plant.
- Constant differential pressure regulation.
- Regulation with constant curve.

The regulating mode may be set through the EVOPLUS SMALL control panel (see par. 10).

8.1.1 Regulation with Proportional Differential Pressure

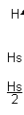

In this regulating mode the differential pressure is reduced or increased as the demand for water decreases or increases.

The H_s set point may be set from the display.

Regulation indicated for:

→ Q - Heating and conditioning plants with high load losses.

- Two-pipe systems with thermostatic valves and head ≥ 4 m.
- Plants with secondary differential pressure regulator.
- Primary circuits with high load losses.
- Domestic water recirculating systems with thermostatic valves on the rising columns.

8.1.2 Regulation with Constant Differential Pressure

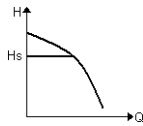

In this regulating mode the differential pressure is kept constant, irrespective of the demand for water, The H_s set point may be set from the display.

Regulation indicated for:

- Heating and conditioning plants with low load losses.
- Two-pipe systems with thermostatic valves and head ≤ 2 m.
- Single-pipe systems with thermostatic valves.
- Plants with natural circulation.
- Primary circuits with low load losses.
- Domestic water recirculating systems with thermostatic valves on the rising columns.

8.1.3 Regulation with constant curve

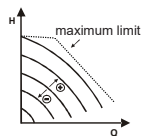

In this regulating mode the circulator works on characteristic curves at a constant speed. The operating curve is selected by setting the rotation speed through a percentage factor. The value 100% indicates the maximum limit curve. The actual rotation speed may depend on the power and differential pressure limits of your circulator model.

The rotation speed may be set from the display.

Regulation indicated for heating and conditioning plants with constant flow.

8.2 Expansion Modules

EVOPUS SMALL circulators may be equipped with some expansion modules that allow their functions to be increased. For details on the procedures for installation, configuration and use of the expansion modules, see the specific manual.

9. CONTROL PANEL

The functions of EVOPUS SMALL circulators can be modified by means of the control panel on the cover of the electronic control device. On the panel there are: a graphic display, 4 navigation keys and 3 LED warning lights (see Figure 5).

9.1 Graphic Display

Using the graphic display it will be possible to navigate in an easy and intuitive menu which will enable you to check and modify the system operating mode and the working set-point. It will also be possible to view the system status and the log of any alarms memorised by the system.

9.2 Navigation Buttons

4 buttons are provided for navigating in the menu: 3 buttons under the display and 1 at the side. The buttons under the display are called active buttons and the one at the side is called hidden button. Each page of the menu is made in such a way as to indicate the function associated with the 3 active buttons (the ones under the display).

9.3 Warning Lights

Yellow light: System live signal.

If lit, it means that the system is live.



Never remove the cover if the yellow light is lit.

Red light: Warning of an **alarm/malfunction present** in the system.

If the light is blinking it is a non-blocking alarm and the pump can still be controlled. If the light is fixed it is a blocking alarm and the pump cannot be controlled.

Green light: Pump ON/OFF signal.

If lit, the pump is running. If off, the pump is stopped.

10. MENU

EVOPUS SMALL circulators offer a user menu accessible from the Home Page by pressing and releasing the central "Menu" button.

Below are shown the user menu pages with which it is possible to check the system status and modify its settings.

If the menu pages show a key at bottom left it means that it is not possible to change the settings. To unlock the menus go to the Home Page and press the hidden button and the button under the key at the same time until the key disappears.

If no button is pressed for 60 minutes, the settings are automatically blocked and the display switches off. When any button is pressed the display lights up again and the "Home Page" appears.







To navigate in the menus, press the central button.



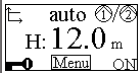
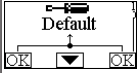

To return to the previous page, hold down the hidden button, then press and release the central button.

To modify the settings use the left and right buttons.

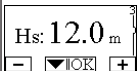
To confirm the change of a setting, hold down the central button "OK" for 3 seconds.

Confirmation will be indicated by the following icon: ▼

<p>Home Page</p> 	<p>The main settings of the system are graphically summed up on the Home Page.</p> <p>The icon at top left indicates the type of regulation selected. The icon at centre top indicates the operating mode selected (auto or economy).</p> <p>The icon at top right indicates the presence of a single or twin inverter. The rotation of the icon ① or ② indicates which circulation pump is operating.</p> <p>At the centre of the Home Page is a read-only parameter which can be chosen from a small set of parameters on Page 9.0 of the menu.</p> <p>From the Home Page it is possible to access the page for regulating the contrast of the display: hold down the hidden button, then press and release the right button.</p> <p>EVOPLUS SMALL circulators offer a user menu accessible from the Home Page by pressing and releasing the central "Menu" button.</p>
<p>Page 1.0</p> 	<p>The factory settings are set from Page 1.0 by holding down the left and right buttons at the same time for 3 seconds.</p> <p>The resetting of the factory settings will be notified by the appearance of the symbol  next to the word "Default".</p>
<p>Page 2.0</p> 	<p>The regulating mode is set from Page 2.0. You can choose between the following modes:</p> <ol style="list-style-type: none">  = Proportional differential pressure regulation.  = Regulation with constant differential pressure.  = Regulation with constant curve with rotation speed set from the display. <p>Page 2.0 displays 3 icons which represent:</p> <ul style="list-style-type: none"> - central icon = setting currently selected; - right icon = next setting; - left icon = previous setting.
<p>Page 3.0</p> 	<p>The regulating set-point can be modified from Page 3.0. Depending on the type of regulation chosen on the previous page, the set-point to be set will be a head or, in the case of a Constant Curve, a percentage of the rotation speed.</p>

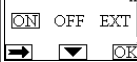
<p>Page 9.0</p> 	<p>On page 9.0 it is possible to choose the parameter to be displayed on the Home Page:</p> <p>H: Measured head expressed in metres Q: Estimated flow rate expressed in m³/h S: Rotation speed expressed in revs per minute (rpm) E: Not present P: Power distributed expressed in W h: Operating hours T: Not present TI: Not present</p>
<p>Page 10.0</p> 	<p>On page 10.0 you can choose the language in which to display the messages.</p>
<p>Page 11.0</p> 	<p>On page 11.0 you can display the alarms log by pressing the right button.</p>
<p>Alarms Log</p> 	<p>If the system finds any faults it records them permanently in the alarms log (up to a maximum of 15 alarms). For each recorded alarm a page composed of 3 parts is displayed: an alphanumeric code that identifies the type of fault, a symbol that illustrates the fault in graphic mode, and a message in the language selected on Page 10.0, giving a brief description of the fault.</p> <p>By pressing the right button you can scroll through all the pages of the log.</p> <p>2 questions appear at the end of the log:</p> <p>1. "Reset Alarms?" Pressing OK (left button) resets any alarms still present in the system.</p> <p>2. "Delete Alarms Log" Pressing OK (left button) deletes the alarms memorised in the log.</p>
<p>Page 13.0</p> 	<p>On page 13.0 you can set the system status in ON or OFF. If ON is selected the pump is always on. If OFF is selected the pump is always off.</p>

11. FACTORY SETTINGS



Parameter	Value
Regulating mode	 = Proportional differential pressure regulation
Twin operating mode	 = Alternate every 24h
Pump start control	ON

Table 1: Factory settings

12. TYPES OF ALARM













Alarm Code	Alarm Symbol	Alarm Description
e0 - e16; e21		Internal Error
e17 - e19		Short Circuit
e20		Voltage Error
e22 - e31		Internal Error
e32 - e35		Electronic system excess temperature
e37		Low voltage
e38		High voltage
e39 - e40		Pump blocked
e46		Pump Disconnected
e42		Dry operation
e56		Motor excess temperature (motor protector trips)
e57		Frequency of PWM external signal less than 100 Hz
e58		Frequency of PWM external signal greater than 5 kHz

Table 2: List of alarms





INFORMATION







Frequently asked questions (faq) on the ecodesign directive 2009/125/ec establishing a framework for the setting of ecodesign requirements for energy-related products and its implementing regulations:

http://ec.europa.eu/enterprise/policies/sustainable-business/documents/eco-design/guidance/files/20110429_faq_en.pdf

Guidelines accompanying commission regulations implementing the ecodesign directive: http://ec.europa.eu/energy/efficiency/ecodesign/legislation_en.htm - see "circulators".

13. ERROR CONDITION AND RESET

Display indication		Description	Reset
e0 - e16		Internal error	<ul style="list-style-type: none"> - Switch off system power. - Wait for the warning lights on the control panel to go off, then power the system again. - If the error persists, change the circulator.
e37		Low mains voltage (LP)	<ul style="list-style-type: none"> - Switch off system power. - Wait for the warning lights on the control panel to go off, then power the system again. - Check that the mains voltage is correct, if necessary reset it at the plate values.
e38		High mains voltage (HP)	<ul style="list-style-type: none"> - Switch off system power. - Wait for the warning lights on the control panel to go off, then power the system again. - Check that the mains voltage is correct, if necessary reset it at the plate values.
e32-e35		Critical over-heating of electronic parts	<ul style="list-style-type: none"> - Switch off system power. - Wait for the warning lights on the control panel to go off. - Check that the system ventilation ducts are not blocked and that the environment temperature of the premises is correct.

e39-e40		Protection against overcurrent	<ul style="list-style-type: none"> - Check that the circulator turns freely. - Check that any antifreeze added does not exceed the maximum percentage of 30%.
e21-e30		Voltage Error	<ul style="list-style-type: none"> - Switch off system power. - Wait for the warning lights on the control panel to go off, then power the system again. - Check that the mains voltage is correct, if necessary reset it at the plate values.
e31		Twin communication absent	<ul style="list-style-type: none"> - Check that the twin communication cable is intact. - Check that both circulators are powered.
e42		Dry operation	<ul style="list-style-type: none"> - Put the system under pressure.
e56		Motor excess temperature	<ul style="list-style-type: none"> - Switch off system power. - Wait for the motor to cool down - Power the system again
e57 ; e58		f < 100 Hz f > 5 kHz	Check that the PWM external signal is operating and connected as specified.

Energy Efficiency Index - EEI

The benchmark for the most efficient circulators is $EEI \leq 0,20$.