



s-box

ISTRUZIONI PER L'INSTALLAZIONE E LA MANUTENZIONE
INSTRUCTIONS FOR INSTALLATION AND MAINTENANCE
INSTRUCTIONS POUR L'INSTALLATION ET L'ENTRETIEN
BEDIENUNGS- UND WARTUNGSANWEISUNGEN
GEBRUIKS- EN ONDERHOUDSAANWIJZINGEN
ИНСТРУКЦИИ ПО МОНТАЖУ И ТЕХОБСЛУЖИВАНИЮ
ASENNUS- JA HUOLTO-OHJEET
INSTALLATIONS - OCH UNDERHÅLLSANVISNING
INSTRUCIUNI DE INSTALARE SI INTRETINERE
ΟΔΗΓΙΕΣ ΕΓΚΑΤΑΣΤΑΣΗΣ ΚΑΙ ΣΥΝΤΗΡΗΣΗΣ
INSTRUCCIONES PARA LA INSTALACIÓN Y EL MANTENIMIENTO
KURULUM VE BAKIM TALİMATI
INSTRUKCJA MONTAŻU I KONSERWACJI
NÁVOD K INSTALACI A ÚDRŽBĚ
INSTALLÁCIÓS ÉS KARBANTARTÁSI KÉZIKÖNYV
ИНСТРУКЦИЯ ЗА МОНТИРАНЕ И ПОДДРЪЖКА
INSTRUÇÕES PARA A INSTALAÇÃO E A MANUTENÇÃO

دفترچه نصب و راهنمای پمپ های مدل



Manuale valido per le versioni firmware 5.x-4.x-1.x

Manual valid for firmware versions 5.x-4.x-1.x

Manuel valide pour les versions micrologiciel 5.x-4.x-1.x

Gültiges Handbuch für die Firmware-Versionen 5.x-4.x-1.x

Handleiding geldig voor de firmware-versies 5.x-4.x-1.x

Руководство действительно для редакции зашитой программы 5.x-4.x-1.x

Käyttöopas laiteohjelmaversioille 5.x-4.x-1.x

Bruksanvisning för programvaruversioner 5.x-4.x-1.x

Manual valabil pentru versiunile de firmware 5.x-4.x-1.x

Εγχειρίδιο έγκυρο για τις εκδόσεις firmware 5.x-4.x-1.x

Manual válido para las versiones firmware 5.x-4.x-1.x

Donanım yazılımının 5.x-4.x-1.x versiyonları için geçerli el kitabı

Instrukcja obowiązująca dla wersji firmware 5.x-4.x-1.x

Příručka platná pro verze firmwaru 5.x-4.x-1.x

A kézikönyv a firmware 5.x-4.x-1.x verzióhoz érvényes (firmware 5.x-4.x-1.x= beépített programverzió)

Валидно за вариант 5.x-4.x-1.x

Manual válido para as versões firmware 5.x-4.x-1.x

IT - ITALIANO	pag	1
GB - ENGLISH	page	57
FR - FRANÇAIS	page	111
DE - DEUTSCH	seite	167
NL - NEDERLANDS	bladz	223
RU - РУССКИЙ	стр.	279
FI - SUOMI	sivu	335
SE - SVENSKA	sida	389
RO - ROMANA	pag.	443
GR - ΕΛΛΗΝΙΚΑ	σελ.	499
ES - ESPAÑOL	pág	555
TR - TÜRKÇE	say	611
PL - POLSKI	str	667
CZ - ČESKY	str.	723
HU - MAGYAR	oldal	779
BG - БЪЛГАРСКИ	Стр.	833
PT - PORTUGUÊS	pág.	885
940	صفحه	فارسی

INDEX

Key	60		
Warnings	60		
Responsibility	61		
1. General	61		
1.1 Description of the Integrated Inverter	62		
1.2 Integrated expansion vessel	62		
1.3 Integrated electropump	63		
1.4 Technical characteristics	64		
2. Installation	65		
2.1 Vertical Configuration	66		
2.1.1 Hydraulic connections	66		
2.1.2 Loading operation – Installation above head and below head	67		
2.2 Horizontal configuration	67		
2.2.1 Hydraulic connections	68		
2.2.2 Orientation of the interface panel	68		
2.2.3 Loading operation – Installation above head and below head	69		
3. Commissioning	69		
3.1 Electrical connections	69		
3.2 Configuration of the integrated inverter	70		
3.3 Priming	70		
4. Protection systems	71		
4.1 Description of blockages	71		
4.1.1 "BL" AAnti Dry-Run (Protection against dry running)	71		
4.1.2 Anti-Cycling (Protection against continuous cycles without utility request)	72		
4.1.3 Anti-Freeze (Protection against freezing of water in the system)	72		
4.1.4 "BP1" Blockage due to fault of the internal pressure sensor	72		
4.1.5 PB" Blockage due to line voltage outside specifications	72		
4.1.6 "SC" Blockage due to short circuit between the motor phases	72		
4.2 Manual reset of error conditions	73		
4.3 Self-reset of error conditions	73		
5. Inverter electronic control and user interface	73		
5.1 Operation with control unit	73		
5.1.1 Functions made available by control units	74		
5.1.2 Electrical connections of utility inputs and outputs	74		
5.1.3 Safety mode operation	74		
5.1.4 Control unit function setup	75		
5.1.5 Association and disassociation of e.sybox and control unit	75		
6. The keypad and the display	76		
6.1 Direct access with a combination of keys	77		
		6.2 Access by name with a drop-down menu	80
		6.3 Structure of the menu pages	81
		6.4 Blocking parameter setting by Password	82
		6.5 Enabling and disabling the motor	82
		7. Meaning of the individual parameters	82
		7.1 User Menu	82
		7.1.1 Status	82
		7.1.2 RS: Rotation speed display	82
		7.1.3 VP: Pressure display	82
		7.1.4 VF: Flow display	82
		7.1.5 PO: Absorbed power display	83
		7.1.6 C1: Phase current display	83
		7.1.7 Operating hours and number of starts	83
		7.1.8 PI: Power histogram	83
		7.1.9 Multi-pump system	83
		7.1.10 Output flow meter	83
		7.1.11 VE: Version display	83
		7.1.12 FF: Fault log display	84
		7.2 Monitor Menu	84
		7.2.1 CT: Display contrast	84
		7.2.2 BK: Display brightness	84
		7.2.3 TK: Backlight switch-on time	84
		7.2.4 LA: Language	84
		7.2.5 TE: Dissipator temperature display	84
		7.3 Setpoint Menu	84
		7.3.1 SP: Setting the setpoint pressure	84
		7.3.2 Setting the auxiliary pressures	84
		7.3.2.1 P1: Setting the auxiliary setpoint 1	85
		7.3.2.2 P2: Setting the auxiliary setpoint 2	85
		7.3.2.3 P3: Setting the auxiliary setpoint 3	85
		7.3.2.4 P4: Setting the auxiliary setpoint 4	85
		7.4 Manual Menu	85
		7.4.1 Status	85
		7.4.2 RI: Speed setting	85
		7.4.3 VP: Pressure display	86
		7.4.4 VF: Flow display	86
		7.4.5 PO: Absorbed power display	86
		7.4.6 C1: Phase current display	86
		7.4.7 RS: Rotation speed display	86
		7.4.8 TE: Dissipator temperature display	86
		7.5 Installer Menu	86
		7.5.1 RP: Setting the pressure fall to restart	86
		7.5.2 OD: Type of plant	86
		7.5.3 AD: Address configuration	86

7.5.4 MS: Measuring system	87	9.4.3 Wireless communication	100
7.5.5 AS: Association of devices	87	9.4.4 Connection and setting of the inputs	100
7.5.6 PR: Remote pressure sensor	88	9.4.5 Parameters linked to multipump operation	100
7.6 Technical Assistance Menu	88	9.4.6 First start of the multipump system	101
7.6.1 TB: Water lack blockage time	88	9.4.7 Multipump adjustment	101
7.6.2 T1: Switch-off time after low pressure signal	89	9.4.8 Assigning the starting order	102
7.6.3 T2: Delay in switching off	89	9.4.9 Max. switching time	102
7.6.4 GP: Proportional gain coefficient	89	9.4.10 Reaching the maximum inactivity time	102
7.6.5 GI: Integral gain coefficient	89	9.4.11 Reserves and number of devices that participate in pumping	102
7.6.6 RM: Maximum speed	89	9.4.12 Wireless Control	103
7.6.7 Setting the number of devices and of reserves	89		
7.6.8 NA: Active devices	89	10. Maintenance	103
7.6.9 NC: Simultaneous devices	89	10.1 Accessory tool	103
7.6.10 IC: Configuration of the reserve	89	10.2 Emptying the system	105
7.6.10.1 Examples of configuration for multipump systems	90	10.3 Non-return valve	105
7.6.11 ET: Max. switching time	90	10.4 Motor shaft	106
7.6.12 AY: Anti Cycling	91	10.5 Expansion Vessel	106
7.6.13 AE: Enabling the anti-block function	91		
7.6.14 AF: Enabling the anti-freeze function	91	11. Updating the e.Sybox firmware	106
7.6.15 Setup of the auxiliary digitali inputs IN1, IN2, IN3, IN4	91	11.1 General	106
7.6.15.1 Disabling the functions associated with the input	92	11.2 Updating the firmware	107
7.6.15.2 Setting external float function	92	11.2.1 Updating between one e.sybox and another	107
7.6.15.3 Setting auxiliary setpoint input function	92	11.2.1.1 Manual updating	107
7.6.15.4 Setting system enabling and fault reset	93	11.2.1.2 Automatic updating	107
7.6.15.5 Setting low pressure detection (KIWA)	94	11.2.1.3 Semiautomatic updating	108
7.6.16 Setup of the outputs OUT1, OUT2	94	11.2.2 Updating the e.sybox by e.sylink	108
7.6.17 O1: Setting output 1 function	95		
7.6.18 O2: Setting output 2 function	95	12. Troubleshooting	108
7.6.19 FW: Firmware update	95		
7.6.20 RF: Fault and warning reset	95	13. Disposal	110
7.6.21 PW: Change password	95		
7.6.21.1 Password for multipump systems	96	14. Guarantee	110
8. Reset and factory settings	96		
8.1 Reset generale del sistema	96		
8.2 Factory settings	96		
8.3 Restoring the factory settings	96		
9. Particular installations	98		
9.1 Inhibiting self-priming	98		
9.2 Wall installation	99		
9.3 Installation with Quick Connection	99		
9.4 Multiple Sets	99		
9.4.1 Introduction to multipump systems	99		
9.4.2 Making a multipump system	99		



KEY

The following symbols have been used in the discussion:



Situation of general danger. Failure to respect the instructions that follow may cause harm to persons and property.



Situation of electric shock hazard. Failure to respect the instructions that follow may cause a situation of grave risk for personal safety.



Notes

WARNINGS

This manual refers to e.sybox products. In the following discussion, the term e.sybox will be used when the characteristics are shared by both models. If the characteristics differ, the models and their differences will be specified.



Read this documentation carefully before installation. Installation and operation must comply with the local safety regulations in force in the country in which the product is installed. Everything must be done in a workmanlike manner. Failure to respect the safety regulations not only causes risk to personal safety and damage to the equipment, but invalidates every right to assistance under guarantee.

Skilled personnel



The electrical and hydraulic connections may only be carried out by skilled personnel in possession of the technical qualifications required by the safety regulations in force in the country in which the product is installed.

The term skilled personnel means persons whose training, experience and instruction, as well as their knowledge of the respective standards and requirements for accident prevention

and working conditions, have been approved by the person in charge of plant safety, authorizing them to perform all the necessary activities, during which they are able to recognize and avoid all dangers. (Definition for technical personnel IEC 364).

The products dealt with in this discussion fall within the type of professional equipment and belong to insulation class 1.



It is the responsibility of the installer to make sure that the power supply system is equipped with an efficient grounding system according to the regulations in force.



To improve immunity to possible noise radiating to other equipment, it is advisable to use separate wiring to power the inverter.



The appliance is not intended to be used by persons (including children) with reduced physical, sensory or mental capacities, or who lack experience or knowledge, unless, through the mediation of a person responsible for their safety, they have had the benefit of supervision or of instructions on the use of the appliance. Children must be supervised to ensure that they do not play with the appliance.

Safety



Use is allowed only if the electric system is in possession of safety precautions in accordance with the regulations in force in the country where the product is installed (for Italy CEI 64/2).



Pumped liquids

The machine has been designed and made for pumping water, free from explosive substances and solid particles or fibres, with a density of 1000 Kg/m³, a kinematic viscosity of 1mm²/s and non chemically aggressive liquids.



The power supply cable must never be used to carry or shift the pump.



Never pull on the cable to detach the plug from the socket.



If the power cable is damaged, it must be replaced by the manufacturer or by their authorised technical assistance service, so as to avoid any risk.

Failure to observe the warnings may create situations of risk for persons or property and will void the product guarantee.

RESPONSIBILITY



The Manufacturer does not vouch for correct operation of the electropumps or answer for any damage that they may cause if they have been tampered with, modified and/or run outside the recommended work range or in contrast with other indications given in this manual.

The Manufacturer declines all responsibility for possible errors in this instructions manual, if due to misprints or errors in copying. The Manufacturer reserves the right to make any modifications to products that it may consider necessary or useful, without affecting their essential characteristics.

1- GENERAL

The product is an integrated system composed mainly of a self-priming multi-stage centrifugal electropump, an electronic circuit that controls it and an expansion vessel.

Applications

Water systems supply and pressure boosting domestic use or industrial use.

On the outside the product appears as a parallelepiped that presents 6 faces as shown in Fig.1.

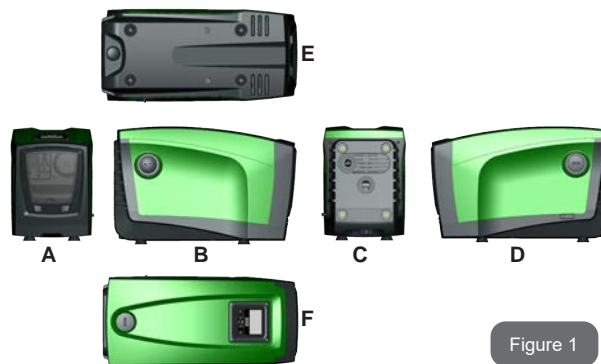

Figure 1

Face A: a door allows access to the Technical Compartment. The door can be removed by inserting 2 fingers in the rubber grips, squeezing and rotating the door around the hinges on the side opposite the grips (see Fig.2). To put the door back in place, insert the hinges in their slots and close the door until it clicks.



Figure 2

Inside the technical compartment you can access (see Fig.3):

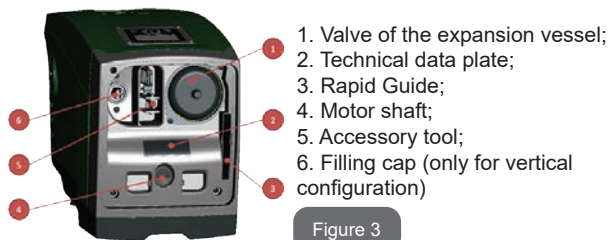

Figure 3

Face B: a removable screw cap gives access to the non return valve (see par. 10.3). Remove it only in the case of maintenance by skilled personnel.

Face C: the 4 brass threads form the seat for the 4 support feet in the case of vertical installation. The two 1" screw caps can be removed to make the connections towards the system, depending on the installation configuration you want to adopt. If applicable, connect to the connection marked "IN" the system from which you want to draw water (well, cistern,...) and connect the delivery system to the connection marked "OUT". There is also a ventilation grid.

Face D: removing the 1" cap allows access to a second delivery connection which can be used at the same time or alternatively to the one marked "OUT" of face C. The power supply cable is for connection to the power mains.

Face E: the 4 brass threads form the seat for the 4 support feet in the case of horizontal installation. The 1" cap has the main function of emptying the system. There are also 2 ventilation grids.

Face F: as indicated by the label to be removed, the 1" cap has a dual function: in the case of horizontal installation, the outlet that is closed by the cap acts as the system's loading door (see below "loading operations", par. 2.2.3); in the case of vertical installation, the same outlet can act as the input hydraulic connection (exactly like the one marked "IN" on face C and as an alternative to it). The user interface panel is composed of a display and a keyboard and its function is to set the system, query its status and communicate any alarms.

The system can be installed in 2 different configurations: horizontal (Fig.4) or vertical (Fig.5).



Figure 4



Figure 5

1.1 Description of the Integrated Inverter

The electronic control integrated in the system is of the type with inverter and it makes use of flow, pressure and temperature sensors, also integrated in the system.

By means of these sensors the system switches on and off automatically according to the utility's needs and it is able to detect conditions of malfunction, to prevent and indicate them.

The Inverter control ensures different functions, the most important of which, for pumping systems, are the maintaining of a constant pressure value in delivery and energy saving.

- The inverter is able to keep the pressure of a hydraulic circuit constant by varying the rotation speed of the electropump. In operation without an inverter the electropump is unable to modulate and, when there is an increase of the request for flow, the pressure necessarily decreases, or vice versa; this means the pressures are too high at low flow rates or too low when there is an increased request for flow.
- By varying the rotation speed according to the instantaneous request of the utility, the inverter limits the power supplied to the electropump to the minimum necessary to ensure that the request is satisfied. Instead, operation without an inverter contemplates

operation of the electropump always and only at maximum power.

The system is configured by the manufacturer to satisfy the majority of installation cases, that is:

- Operation at constant pressure;
- Set-Point (desired value of constant pressure: SP = 3.0 bar
- Reduction of pressure to restart: RP = 0.3 bar
- Anti-cycling function: Disabled

However, these parameters and others can be set according to the system. All the settable values are illustrated in the par. 5-6-7: pressure, intervention of protections, rotation speed, etc.

There are many other operating modes and accessory functions. Thanks to the different possible settings and the availability of configurable input and output channels, it is possible to adapt the inverter operation to the requirements of various systems. See 5-6-7.

1.2 Integrated Expansion Vessel

The system is complete with an integrated expansion vessel with a total capacity of 2 litres. The main functions of the expansion vessel are:

- to make the system elastic so as to protect it against water hammer;
- to ensure a water reserve which, in the case of small leaks, maintains the pressure in the system for a longer time and spreads out needless restarts of the system which otherwise would be continuous;
- when the utility is turned on, ensure the water pressure for the seconds that the system takes to switch on and reach the correct rotation speed.

It is not a function of the integrated expansion vessel to ensure a water reserve such as to reduce interventions of the system (requests from the utility, not from a leak in the system). It is possible to add an expansion vessel with the capacity you prefer to the system, connecting it to a point on the delivery system (not a suction point!). In the case of horizontal installation

it is possible to connect to the unused delivery outlet. When choosing the tank, consider that the quantity of water released will also depend on the parameters SP and RP that can be set on the system (par.6-7).

The expansion vessel is preloaded with pressurised air through the valve accessible from the technical compartment (Fig.3, point 1). The preload value with which the expansion vessel is supplied by the manufacturer is in agreement with the parameters SP and RP set as default, and anyway it satisfies the following equation:

$$Pair = SP - RP - 0.7bar$$

Where:

- Pair = air pressure value in bar
- SP = Set Point (par.7.3) in bar
- RP = Reduction of pressure to restart (par. 7.5.1) in bar

So, by the manufacturer:

$$Pair = 3.0 - 0.3 - 0.7 = 2.0 \text{ bar}$$

If different values are set for the parameters SP and/or RP, regulate the valve of the expansion vessel releasing or letting in air until the above equation is satisfied again (e.g.: SP=2.0bar; RP=0.3bar; release air from the expansion vessel until a pressure of 1.0 bar is reached on the valve).



Failure to respect the above equation may lead to malfunctions of the system or to premature breakage of the diaphragm inside the expansion vessel.



Considering the expansion vessel capacity of only 2 litres, any operation to check the air pressure must be performed by connecting the pressure gauge very rapidly: on small volumes the loss of even a limited quantity of air can cause an appreciable drop in pressure. The quality of the expansion vessel ensures the maintenance of the set air pressure value, proceed to check it only at calibration or if you are sure of a malfunction.



Any operation to check and/or reset the air pressure must be performed with the delivery system not under pressure: disconnect the pump from the power supply and open the utility nearest to the pump, keeping it open until it no longer gives any water.



The special structure of the expansion vessel ensures its quantity and duration over time, especially of the diaphragm which is typically the component subject to wear for items of this type. However, in the case of breakage, the entire expansion vessel must be replaced and exclusively by authorised personnel.

1.3 Integrated electropump

The system has a built-in centrifugal electropump of the multi-impeller type driven by a water-cooled three-phase electric motor. Cooling of the motor with water rather than air ensures less noise in the system and the possibility of locating it even in recesses without ventilation.

The diagram in Fig. 6 shows the curves of the hydraulic performance for e.sybox. By automatically modulating the rotation speed of the electropump, the inverter allows it to shift its work point according to necessities to any part of the area subtended by its curve, to keep the set pressure valve constant (SP). The red curve shows the behaviour of the e.sybox with set point at 3.0 bar.

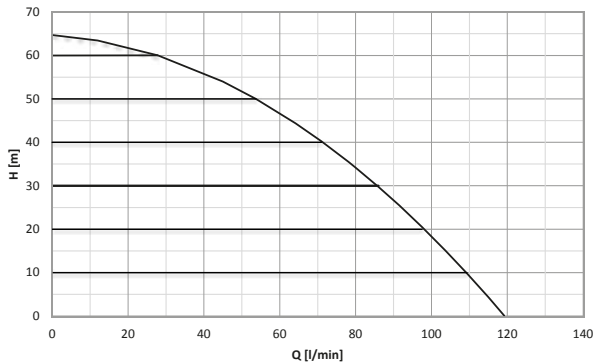

Figure 6

It results that, with SP = 3.0 bar, the system is able to ensure a constant pressure at the users that require flow rates respectively between 0 and 85 litres/minute. For higher flow rates the system works according to the characteristic curve of the electropump at maximum rotation speed. For flow rates lower than the limits described above, as well as ensuring constant pressure, the system reduces the absorbed power and therefore the energy consumption.



The above performances are to be considered measured at ambient temperature and water at about 20°C, during the first 10 minutes of motor operation, with water level at suction at a depth of no more than 1 metre



As the suction depth increases, the performance of the electropump decreases.

1.4 Technical characteristics

Text	Parameter	e.sybox
ELECTRIC POWER SUPPLY	Voltage	1 x 220/240 ~ VAC
	Frequency	50/60 Hz
	Maximum current	10 A
	Maximum power	1550 W
	Leakage current to earth	<2,5 [ma]
CONSTRUCTION CHARACTERISTICS	Overall dimensions	565x265x352 mm without feet
	Empty weight (excluding packaging)	24,8 kg
	Protection class	IP x4
	Motor insulation class	F

HYDRAULIC PERFORMANCE	Maximum head	65 m
	Maximum flow rate	120 l/min
	Priming	<5min at 8m
WORKING CONDITIONS	Maximum working pressure	8 bar
	Liquid temperature max	40 °C
	Environment temperature max	50 °C
	Storage environment temperature	-10÷60 °C
FUNCTIONALITY AND PROTECTIONS	Constant pressure	
	Wireless communication	
	Protection against dry running	
	Antifreeze protection	
	Anticycling protection	
	Motor overload protection	
	Protection against abnormal supply voltages	
	Protection against excess temperature	

2- INSTALLATION



The system is designed for indoor use: do not install the system outdoors and/or directly exposed to atmospheric agents.



The system is designed to be able to work in environments where the temperature remains between 0°C and 50°C (on condition that the electric power supply is ensured: see par. 7.6.14 “anti-freeze function”).



The system is suitable for treating drinking water.



The system cannot be used to pump salt water, sewage, inflammable, corrosive or explosive liquids (e.g. petroleum, petrol, thinners), greases, oils or food products.



The system can take in water the level of which must not be at a depth greater than 8m (the height between the water level and the pump suction mouth).



Do not connect any pipe to the 1¼” mouth that houses the non-return valve, see fig. 27.



If the system is used for the domestic water supply, respect the local regulations of the authorities responsible for the management of water resources.



When choosing the installation site, check that:

The voltage and frequency on the pump's technical data plate correspond to the values of the power supply system.

- The electrical connection is made in a dry place, far from any possible flooding.
- The electrical system is provided with a differential switch with $I_{\Delta n} \leq 30$ mA and that the earth system is efficient.

If you are not sure of the absence of foreign bodies in the water to be pumped, install a filter on the system intake that is suitable for catching impurities.



The installation of a filter on intake causes a decrease of the system's hydraulic performance proportional to the loss of load caused by the filter itself (generally the greater the filtering power, the greater the fall in performance).

Choose the type of configuration you intend to use (vertical or horizontal) considering the connections to the system, the position of the user interface panel, and the spaces available according to the indications below. Other types of installation configuration are possible using DAB accessory interfaces: see dedicated paragraph (par.9.2, 9.3).

2.1 - Vertical Configuration

Remove the 4 support feet from the bottom tray of the packaging and screw them fully into their brass seats on face C. Put the system in place, taking into account the dimensions in Fig.7.

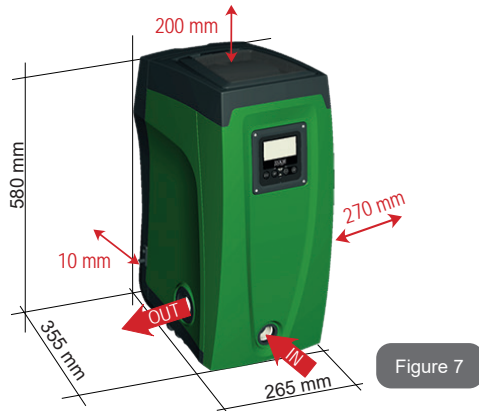

Figure 7

- The distance of at least 10mm between Face E of the system and any wall is obligatory to ensure ventilation through the grids provided.
- The distance of at least 270mm between Face B of the system and an obstruction is recommended so as to be able to carry out maintenance on the non-return valve without disconnecting the system.
- The distance of at least 200mm between Face A of the system and an obstruction is recommended so as to be able to remove the door and gain access to the technical compartment.

If the surface is not flat, unscrew the foot that is not touching and adjust its height until it contacts the surface so as to ensure the stability of the system. The system must in fact be placed in a safe and stable position, ensuring that its axis is vertical: it must not be in an inclined position.

2.1.1 Hydraulic connections

Make the connection at input to the system through the mouth on Face F marked "IN" in Fig.7 (suction connection). Then remove the respective cap with the aid of the accessory tool or with a screwdriver.

Make the connection at output from the system through the mouth on Face F marked "OUT" in Fig.8 (delivery connection). Then remove the respective cap with the aid of the accessory tool or with a screwdriver.

All the hydraulic connections of the system to the plant to which it can be connected are of the threaded female type 1" GAS, made of brass.



If you intend to connect the product to the plant with fittings that have a diameter larger than the normal 1" pipe (for example the ring nut in the case of fittings in 3 pieces), make sure that the 1" Gas male thread of the coupling protrudes at least 25mm from the above diameter (see Fig.8)

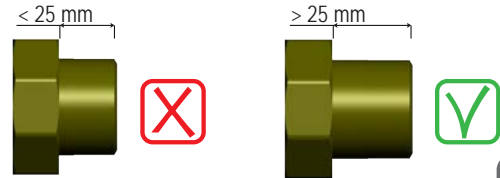

Figure 8

With reference to its position with respect to the water to be pumped, the installation of the system may be defined "above head" or "below head". In particular the installation is defined "above head" when the pump is placed at a level higher than the water to be pumped (e.g. pump on the surface and water in a well); vice versa it is "below head" when the pump is placed at a level lower than the water to be pumped (e.g. overhead cistern and pump below).



If the vertical installation of the system is of the "over head" type, it is recommended to fit a non-return valve in the suction section of the system; this is to allow the operation of loading the system (par. 2.1.2).



If the installation is of the “over head” type, install the suction pipe from the water source to the pump in such a way as to avoid the formation of goosenecks or siphons. Do not place the suction pipe above the pump level (to avoid the formation of air bubbles in the suction pipe). The suction pipe must draw at its entrance at a depth of at least 30cm below the water level and must be watertight along its whole length, as far as the entrance to the electropump.



The suction and delivery pipes must be fitted so that they do not exert any mechanical pressure on the pump.

2.1.2 Loading Operation

Installation above head and below head

Installation “above head” (par. 2.1.1): access the technical compartment and, with the aid of the accessory tool (Fig.3_point 5) or with a screwdriver, remove the filling cap (Fig.3_point 6). Fill the system with clean water through the loading door, taking care to let the air out. If the non-return valve on the suction pipe (recommended in paragraph 2.1.1) has been placed close to the system entry door, the quantity of water with which to fill the system should be 2.2 litres. It is recommended to fit the non-return valve at the end of the suction pipe (foot valve) so as to be able to fill it quickly too during the loading operation. In this case the quantity of water necessary for the loading operation will depend on the length of the suction pipe (2.2 litres + ...).

Installation “below head” (par. 2.1.1): if there are no check valves between the water deposit and the system (or if they are open), it loads automatically as soon as it is allowed to let out the trapped air. So slackening the filling cap (Fig.3_point 6) enough to vent the trapped air allows the system to load completely. You must survey the operation and close the loading door as soon as the water comes out (however it is recommended to fit a check valve in the section of the suction pipe and to use it to control the loading operation with the cap open). Alternatively, in the case where the suction pipe is intercepted by a closed valve, the loading operation may be carried out in a similar way to the one described for installation over head.

2.2 - Horizontal Configuration

Remove the 4 support feet from the bottom tray of the packaging and screw them fully into their brass seats on face E. Put the system in place, taking into account the dimensions in Fig.9.

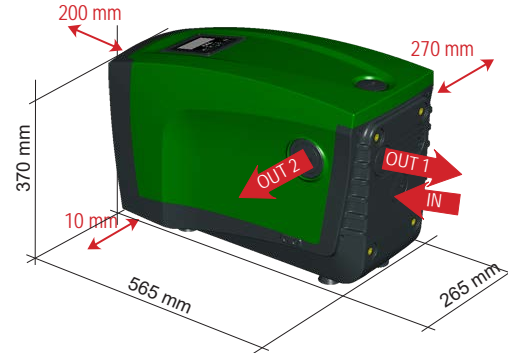

Figure 9

- The distance of at least 270mm between Face B of the system and an obstruction is recommended so as to be able to carry out maintenance on the non-return valve without disconnecting the system.
- The distance of at least 200mm between Face A of the system and an obstruction is recommended so as to be able to remove the door and gain access to the technical compartment.
- The distance of at least 10mm between Face D of the system and an obstruction is obligatory to let out the power supply cable.

If the surface is not flat, unscrew the foot that is not touching and adjust its height until it contacts the surface so as to ensure the stability of the system. The system must in fact be placed in a safe and stable position, ensuring that its axis is vertical: it must not be in an inclined position.

2.2.1 Hydraulic connections

Make the connection at input to the system through the mouth on Face C marked "IN" in Fig.9 (suction connection). Then remove the respective cap with the aid of the accessory tool or with a screwdriver.

Make the connection at output from the system through the mouth on Face C marked "OUT 1" in Fig.9 and/or through the mouth on Face D marked "OUT 2" in Fig.9 (delivery connection). In this configuration either of the 2 mouths can be used as an alternative to the other (depending on the convenience of the installation), or simultaneously (dual delivery system). So remove the cap(s) from the door(s) you intend to use with the aid of the accessory tool or with a screwdriver.

All the hydraulic connections of the system to the plant to which it can be connected are of the threaded female type 1" GAS, made of brass.



See WARNING for Figure 8.

2.2.2 Orientation of the Interface Panel

The Interface Panel has been designed so that it can be oriented in the direction where it is most convenient for the user to read: its square shape allows it to be rotated from 90° to 90° (Fig.10).

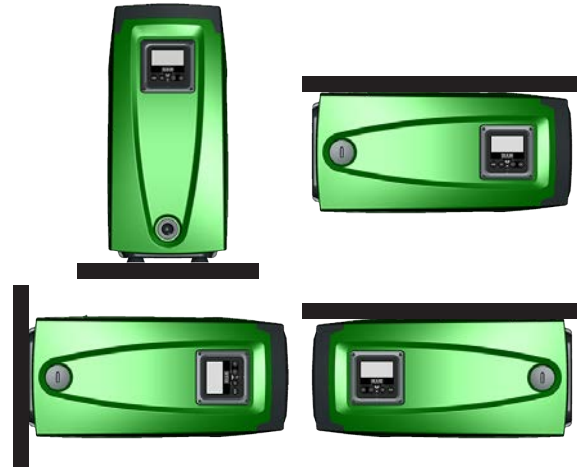

Figure 10

- Disengage the 4 screws at the corners of the panel using the hex wrench provided with the accessory tool.
- Do not remove the screws, just disengage them from the thread on the product body.
- Be careful not to drop the screws into the system.
- Move the panel away, taking care not to pull on the signal transmission cable.
- Reposition the panel in its seat at the preferred angle taking care not to pinch the cable.
- Tighten the 4 screws with the wrench.

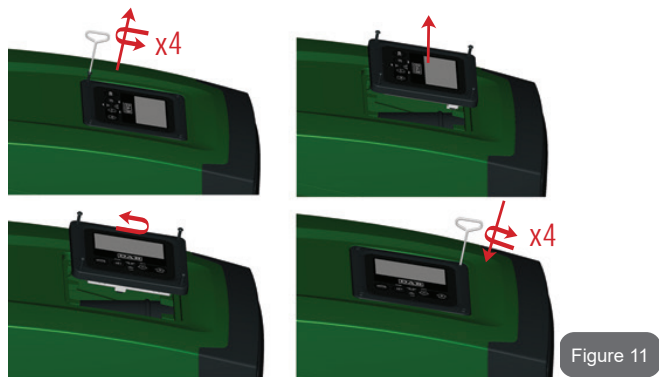

Figure 11

2.2.3 Loading Operation

Installation above head and below head

With reference to its position with respect to the water to be pumped, the installation of the system may be defined “above head” or “below head”. In particular the installation is defined “above head” when the pump is placed at a level higher than the water to be pumped (e.g. pump on the surface and water in a well); vice versa it is “below head” when the pump is placed at a level lower than the water to be pumped (e.g. overhead cistern and pump below).

Installation “above head”: with the aid of the accessory tool (Fig.3_point 5) or with a screwdriver, remove the filling cap which, for the horizontal configuration, is the one on Face F (Fig.1). Fill the system with clean water through the loading door, taking care to let the air out. The quantity of water with which to fill the system must be at least 1.5 litres. It is recommended to fit a non-return valve at the end of the suction pipe (foot valve) so as to be able to fill it quickly too during the loading operation. In this case the quantity of water necessary for the loading operation will depend on the length of the suction pipe (1.5 litres + ...). Installation “below head”: if there are no check valves between the water deposit and the system (or if they are open), it loads automatically as soon as it is allowed to let out the trapped air. So slackening the filling cap (Face F - Fig.3) enough to vent the air allows the system to load completely. To slacken the

cap, use the accessory tool (Fig.3_point 5) or a screwdriver. You must survey the operation and close the loading door as soon as the water comes out (however it is recommended to fit a check valve in the section of the suction pipe and to use it to control the loading operation with the cap loose). Alternatively, in the case where the suction pipe is intercepted by a closed valve, the loading operation may be carried out in a similar way to the one described for installation over head.

3 - COMMISSIONING



Maximum working pressure 8 bar.



The intake depth must not exceed 8m.

3.1 - Electrical Connections

To improve immunity to the possible noise radiated towards other appliances it is recommended to use a separate electrical duct to supply the product.



The line voltage may change when the electropump is started. The line voltage may undergo variations depending on other devices connected to it and on the quality of the line.

It is recommended to carry out installation as indicated in the manual, in compliance with the laws, directives and standards in force in the place of use and depending on the application. The product contains an inverter inside which there are continuous voltages and currents with high-frequency components (see table 1a).

Type of possible fault currents to earth			
Alternating	Unipolar pulsed	Direct	With high-frequency components
X	X	X	X

Table 1a

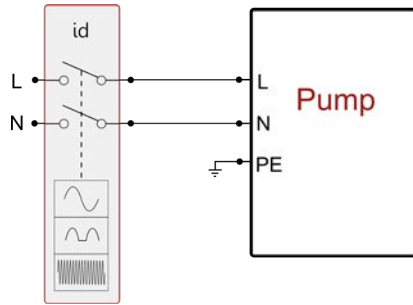

Figure 11 - bis Installation example

The thermal magnetic circuit breaker must be correctly sized (see Electrical Characteristics).

The appliance must be connected to a main switch that cuts off all the power supply poles. When the switch is in off position, the distance separating each contact must respect the indications in table 1b.

Minimum distance between the contacts of the power switch	
Minimum distance [mm]	>3

Table 1b

3.2 Configuration of the Integrated Inverter

The system is configured by the manufacturer to satisfy the majority of installation cases, that is:

- operation at constant pressure;
- Set-Point (desired value of constant pressure): SP = 3.0 bar
- Reduction of pressure to restart: RP = 0.3 bar
- Anti-cycling function: Disabled

However, all these parameters and many others can be set by the user.

There are many other operating modes and accessory functions. Thanks to the different possible settings and the availability of configurable input and output channels, it is possible to adapt the inverter operation to the requirements of various systems. See par. 5-6-7



For the definition of the parameters SP and RP, the pressure at which the system starts has the value:

Pstart = SP – RP For example: 3.0 – 0.3 = 2.7 bar
in the default configuration

The system does not work if the utility is at a height higher than the equivalent in metres of water column of the Pstart (consider 1 bar = 10 m water column): for the default configuration, if the utility is at a height of at least 27m the system does not start.

3.3 - Priming

The priming of a pump is the phase during which the machine attempts to fill the body and the suction pipe with water. If the operation is successful the machine can work regularly.

Once the pump has been filled (par. 2.1.2, 2.2.3) and the device has been configured (par. 3.2), it is possible to connect the electric power supply after having opened at least one utility on delivery.

The system starts and checks the presence of water in delivery for the first 10 seconds.

If a flow of water is detected in delivery, the pump is primed and starts its regular work. This is the typical case of installation below head (par. 2.1.2, 2.2.3). The utility opened in delivery from which the pumped water is coming out can be closed.

If a regular flow in delivery is not detected after 10 seconds, the system asks for confirmation to enter the priming procedure (typical case of installation above head par. 2.1.2, 2.2.3). Or:



When “+” is pressed the pump enters the priming procedure: it starts working for a maximum time of 5 minutes during which the safety block for dry operation is not tripped. The priming time depends on various parameters, the most influential of which are the depth of the water level from which it is drawing, the diameter of the suction pipe, the water-tightness of the suction pipe. On condition that a suction pipe is used that is no smaller than 1” and that it is well sealed (with no holes or joins from which it can take in air), the product has been studied to manage to prime in water conditions up to 8m in depth, in a time of less than 5 minutes. As soon as the product detects a regular flow in delivery, it leaves the priming procedure and starts its regular work. The utility opened in delivery from which the pumped water is coming out can be closed. If after 5 minutes of the procedure the product is still not primed, the interface display sends a failure message. Disconnect the power supply, load the product adding new water, wait 10 minutes and repeat the procedure from the moment you put the plug in the socket.

Press “-” to confirm that you do not want to start the priming procedure. The product remains in alarm status

Operation

Once the electropump is primed, the system starts regular operation according to the configured parameters: it starts automatically when the tap is turned on, supplies water at the set pressure (SP), keeps the pressure constant even when other taps are turned on, stops automatically after time T2 once the switching off conditions are reached (T2 can be set by the user, factory value 10 sec).

4 - PROTECTION SYSTEMS

The device is equipped with protection systems to preserve the pump, the motor, the supply line and the inverter. If one or more protections trip, the one with the highest priority is immediately notified on the display. Depending on the type of error the motor may stop, but when normal conditions are restored the error status may be cancelled immediately or only after a certain time, following an automatic reset.

In the case of blockage due to water lack (BL), blockage due to motor overload (OC), blockage due to direct short circuit between the motor phases (SC), you can try to exit the error conditions manually by simultaneously

pressing and releasing the + and – keys. If the error condition remains, you must take steps to eliminate the cause of the fault.

In the event of blocking due to one of the internal errors E18, E19, E20, E21 it is necessary to wait 15 minutes with the machine powered until the blocked status is automatically reset.

Alarm in the fault log	
Display indication	Description
PD	Irregular switching off
FA	Problems in the cooling system

Table 1: Alarms

Blockage conditions	
Display indication	Description
PH	Cutout due to pump overheating
BL	Blockage due to water lack
BP1	Blockage due to reading error on the internal pressure sensor
PB	Blockage due to supply voltage outside specifications
OT	Blockage due to overheating of the power stages
OC	Blockage due to motor overload
SC	Blockage due to short circuit between the motor phases
ESC	Blockage due to short circuit to earth
HL	Hot liquid
NC	Blockage due to motor disconnected
Ei	Blockage due to i-th internal error
Vi	Blockage due to i-th internal voltage out of tolerance
EY	Block for cyclicity abnormal detected on the system

Table 2: Indications of blockages

4.1 - Description of blockages

4.1.1 - "BL" Anti Dry-Run (Protection against dry running)

In the case of lack of water the pump is stopped automatically after the time TB. This is indicated by the red "Alarm" led and by the letters "BL" on the display.

After having restored the correct flow of water you can try to leave the protective block manually by pressing the "+" and "-" keys simultaneously and then releasing them.

If the alarm status remains, or if the user does not intervene by restoring the flow of water and resetting the pump, the automatic restart will try to restart the pump.



If the parameter SP is not correctly set, the protection against water lack may not work correctly.

4.1.2 - Anti-Cycling (Protection against continuous cycles without utility request)

If there are leaks in the delivery section of the plant, the system starts and stops cyclically even if no water is intentionally being drawn: even just a slight leak (a few ml) can cause a fall in pressure which in turn starts the electropump.

The electronic control of the system is able to detect the presence of the leak, based on its recurrence.

The Anti-Cycling function can be excluded or activated in Basic or Smart mode (par 7.6.12).

In Basic mode, once the condition of recurrence is detected the pump stops and remains waiting to be manually reset. This condition is communicated to the user by the lighting of the red "Alarm" led and the appearance of the word "ANTICYCLING" on the display. After the leak has been removed, you can manually force restart by simultaneously pressing and releasing the "+" and "-" keys.

In Smart mode, once the leak condition is detected, the parameter RP is increased to decrease the number of starts over time.

4.1.3 - Anti-Freeze (Protection against freezing of water in the system)

The change of state of water from liquid to solid involves an increase in volume. It is therefore essential to ensure that the system does not remain full of water with temperatures close to freezing point, to avoid breakages of the system. This is the reason why it is recommended to empty any electropump that is going to remain unused during the winter. However, this system has a protection that prevents ice formation inside by activating the electropump when the temperature falls to values close to freezing point. In this way the water inside is heated and freezing prevented.



The Anti-Freeze protection works only if the system is regularly fed: with the plug disconnected or in the absence of current the protection cannot work.

However, it is advised not to leave the system full during long periods of inactivity: drain the system accurately through the drainage cap (Fig.1 Face E) and put it away in a sheltered place.

4.1.4 - "BP1" Blockage due to fault of the internal pressure sensor

If the device detects a fault in the pressure sensor the pump remains blocked and the error signal "BP1" is given. This status begins as soon as the problem is detected and ends automatically when correct conditions have been restored.

4.1.5 - "PB" Blockage due to supply voltage outside specifications

This occurs when the allowed line voltage at the supply terminal assumes values outside the specifications. It is reset only automatically when the voltage at the terminal returns within the allowed values.

4.1.6 - "SC" Blockage due to short circuit between the motor phases

The device is provided with protection against the direct short circuit which may occur between the motor phases. When this blockage is indicated you can attempt to restore operation by simultaneously holding down the + and - keys, but this will not have any effect until 10 seconds have passed since the moment the short circuit occurred.

4.2 - Manual reset of error conditions

In error status, the user can cancel the error by forcing a new attempt, pressing and then releasing the + and – keys.

4.3 - Self-reset of error conditions

For some malfunctions and blockage conditions, the system attempts automatic self-reset.

The auto self-reset procedure concerns in particular:

- “BL” Blockage due to water lack
- “PB” Blockage due to line voltage outside specifications
- “OT” Blockage due to overheating of the power stages
- “OC” Blockage due to motor overload
- “BP” Blockage due to fault of the pressure sensor

For example, if the system is blocked due to water lack, the device automatically starts a test procedure to check whether the machine is really left definitively and permanently dry. If during the sequence of operations an attempted reset is successful (for example, the water comes back), the procedure is interrupted and normal operation is resumed.

Table 21 shows the sequences of the operations performed by the device for the different types of blockage.

Automatic resets of error conditions		
Display indication	Description	Automatic reset sequence
BL	Blockage due to water lack	<ul style="list-style-type: none"> - One attempt every 10 minutes for a total of 6 attempts - One attempt every hour for a total of 24 attempts - One attempt every 24 hours for a total of 30 attempts

PB	Blockage due to line voltage outside specifications	- It is reset when it returns to a specific voltage
OT	Blockage due to overheating of the power stages	- It is reset when the temperature of the power stages returns within the specifications.
OC	Blockage due to motor overload	<ul style="list-style-type: none"> - One attempt every 10 minutes for a total of 6 attempts - One attempt every hour for a total of 24 attempts - One attempt every 24 hours for a total of 30 attempts

Table 3: Self-reset of blockages

5 - INVERTER ELECTRONIC CONTROL AND USER INTERFACE



The inverter makes the system work at constant pressure. This regulation is appreciated if the hydraulic plant downstream from the system is suitably sized. Plants made with pipes with too small a section introduce load losses that the equipment cannot compensate; the result is that the pressure is constant on the sensors but not on the utility.



Plants that are excessively deformable can create the onset of oscillations; if this occurs, the problem can be solved by adjusting the control parameters “GP” and “GI” (see par 7.6.4 - GP: Proportional gain coefficient and 7.6.5 - GI: Integral gain coefficient).

5.1 - Operation with control unit

e.sybox, alone or in a pumping unit, may be connected by means of wireless communication to a remote unit referred to below as a control unit. Depending on the model, the control unit offers a variety of functions. The possible control units are:

- e.sylink

Combining one or more e.syboxes with a control unit allows the use of:

- Digital inputs
- Relay outputs
- Remote pressure sensor
- Ethernet network connection

Below, the combination of functions listed above, made available by the various types of control unit, will be referred to as “control unit functions

5.1.1 - Functions made available by control units

The functions made available are specified in Table 4, Functions made available by control units

Functions	e.sylink
Opto-isolated digital inputs	●
Output relay with NO contact	●
Remote pressure sensor	●
Network connection	

Tab. 4: Functions made available by control units

5.1.2 - Electrical connections of utility inputs and outputs

See control unit manual.

5.1.3 - Safety mode operation

When using the input or remote sensor functions, in the event of a communications down age or control unit error, the e.sysbox and control unit will switch to safety mode, adopting the configuration considered least damaging. When safety mode comes into operation, a flashing icon showing a cross inside a triangle appears on the display.

The way in which the e.sysbox responds to a communications down age is explained in the table below.

e.sybox setting	e.sybox response			
	No control unit associated	Control unit associated		
		Communication with control unit		No communication with control unit, or control unit error Safety mode
	Function activated (by means of input or menu)	Function not activated (by means of input or menu)		
in=0 Input function disabled	No action	No action	No action	No action
in⁽²⁾=1, 2 Low water level indicated by float switch	No action	System in stop status F1	No action	System in stop status ⁽¹⁾
in⁽²⁾=3, 4 Pauxn auxiliary setpoint	No action	Activation of corresponding auxiliary setpoint	No action	Activation of lowest auxiliary setpoint pressure set
in⁽²⁾=5, 6 Disable system	No action	System in stop status F3	No action	System in stop status ⁽¹⁾
in⁽²⁾=7, 8 Disable system + fault and warning reset	No action	System in stop status F3 + fault and warning reset	No action	System in stop status ⁽¹⁾
in =9 Fault and warning reset	No action	Fault and warning reset	No action	No action

in ⁽²⁾ =10, 11, 12, 13 Kiwa function (low input pressure signal)	No action	System in stop status F4	No action	System in stop status ⁽¹⁾
PR=0 Remote pressure sensor disabled	No action	No action	No action	No action
PR=1 Use of remote pressure sensor	No action	Setpoint on remote sensor	No action	Remote setpoint ignored

Tab.5 Triggering of safety mode

⁽¹⁾ The activation of the function relating to this box + any other function in safety mode triggers a system stop. In this case, the system displays the highest priority stoppage cause.

⁽²⁾ The numbers separated by commas indicate the possible setting values for the function concerned

Instead, as regards the control unit, if there is a loss of communication it lights relay 1 depending on the settings of O1 (see tab 20), considering the lack of communication an error condition.

5.1.4 - Control unit function setup

The default value of all the inputs and the remote pressure sensor is DISABLE, so before they can be used, they must be activated by the user; see point 7.6.15 - Setup of auxiliary digital inputs IN1, IN2, IN3, IN4, pressure sensor point 7.5.6 - PR: Remote pressure sensor.

The outputs are enabled by default, see output functions point 7.6.16 - Setup of outputs OUT1, OUT2.

If no control unit has been associated, the input, output and remote pressure sensor functions are ignored and have no effect, regardless of their setups.

The control unit parameters (inputs, outputs and pressure sensors) can be set even if the connection is down or even not made.

If the control unit is associated (it is included in the e.sybox's wireless network) but is not present or not visible due to problems, when the parameters related to these functions are set at a value other than disable they blink to indicate that they will not be able to fulfil their functions.

5.1.5 - Association and disassociation of e.sybox and control unit

The procedure for associating a control unit to an e.sybox is the same as for associating an e.sybox:

locate the AS page of the installer menu and hold down the "+" key for 5 sec., until the blue LED blinks (whether the e.sybox is stand-alone or in a group). After this, press the ► key for 5 sec. until the blue communication LED starts to blink. As soon as the connection has been established, the LED becomes steady and the e.sylink symbol appears on the AS page of the e.sybox.

The procedure for disassociating the e.sylink is the same as for the e.sybox: locate the AS page of the installer menu and hold down the "-" key for 5 sec; this will eliminate all the wireless connections present.

6 - THE KEYPAD AND THE DISPLAY





Figure 12: Aspect of the user interface

The user interface is composed of a keypad with 128x240 pixel LCD display and with POWER, COMM, ALARM warning leds as can be seen in Figure 12.

The display shows the values and the statuses of the device, with indications on the functionality of the various parameters.

The functions of the keys are summed up in Table 6.

	The MODE key allows you to move on to the next items in the same menu. Holding it down for at least 1 sec allows you to skip to previous menu item.
	The SET key allows you to leave the current menu.



	Decreases the current parameter (if it is an editable parameter).
	Increases the current parameter (if it is an editable parameter).

Table 6: Key functions

Holding down the “+” key or the “-” key allows the automatic increase/decrease of the parameter selected. After the “+” key or the “-” key has been held down for 3 seconds, the automatic increase/decrease speed increases.



When the + key or the - key is pressed the selected value is modified and saved immediately in the permanent memory (EEPROM). If the machine is switched off, even accidentally, in this phase it does not cause the loss of the parameter that has just been set.

The SET key is only for leaving the current menu and is not necessary for saving the changes made. Only in particular cases described in chapter 0 are some values updated by pressing “SET” or “MODE”.

Warning leds

- Power
White led. Lit with a fixed light when the machine is powered. Blinking when the machine is disabled (see par. 6.5).
- Alarm
Red led. Lit with a fixed light when the machine is blocked by an error.
- Communication
Blue led. Lit with a fixed light when communication wireless is used and is working correctly. It blinks with a slow frequency if,

when configured to work in communication mode, communication is not available, is not detected, or there are problems. It blinks with a high frequency during association with other wireless devices. Off if communication is not used.

Menus

The complete structure of all the menus and of all the items of which they are composed is shown in Table 9.

Access to the menus

The various menus can be accessed from the main menu in two ways:

- 1 - Direct access with a combination of keys
- 2 - Access by name with a drop-down menu

6.1 Direct Access with a Combination of Keys

The desired menu can be accessed directly by pressing simultaneously the appropriate combination of keys for the required time (for example MODE SET to enter the Setpoint menu) and the various items in the menu are scrolled with the MODE key.

Table 7 shows the menus that can be reached with the combinations of keys.





















MENU NAME	DIRECT ACCESS KEYS	HOLD-DOWN TIME
User		On releasing the button
Monitor	 	2 Sec
Setpoint	 	2 Sec
Manual	  	5 Sec
Installer	  	5 Sec
Technical assistance	  	5 Sec
Reset factory values	 	2 sec after switching on appliance
Reset	   	2 Sec

Table 7: Access to the menus

<i>Reduced menu (visible)</i>			<i>Extended menu (direct access or password)</i>			
Main Menu	User Menu mode	Monitor Menu set-minus	Setpoint Menu mode-set	Manual Menu set-minus-plus	Installer Menu mode-set-minus	Tech. Assist. Menu mode-set-plus
MAIN (Main Page)	STATUS RS Revs per minute	CT Contrast	SP Setpoint pressure	STATO RI Speed setting	RP Decrease pressure for restart	TB Block time for water lack.
Menu Selection	VP Pressure	BK Back lighting	P1 Auxiliary setpoint 1	VP Pressure	OD Type of plant	T1 Low pr delay
	VF Display of flow	TK Backlighting switch-on time	P2 Auxiliary setpoint 2	VF Display of flow	AD Address Configuration	T2 Delay in switching off
	PO Power absorbed by pump	LA Language	P3 Auxiliary setpoint 3	PO Power absorbed by pump	MS Measuring system	GP Proportional gain.
	C1 Pump phase current	TE Dissipator temperature	P4 Auxiliary setpoint 4	C1 Pump phase current	AS Wireless Devices	GI Integral gain
	Hours switched on			RS Revs per minute	PR Remote pressure sensor	RM Maximum speed
	Working hours			TE Dissipator temperature		NA Active devices
	Number of starts					NC Max. simultaneous devices
	PI Power histogram					IC Device configuration
	Multi-pump system					ET Max. switching time
	Output flow meter					
	VE Informazioni HW e SW					

	FF Fault & Warning (Log)					AY Anti Cycling
						AE Anti-blocking
						AF AntiFreeze
						I1 Function input 1
						I2 Function input 2
						I3 Function input 3
						I4 Function input 4
						O1 Function output 1
						O2 Function output 2
						FW Firmware update
						RF Reset faults and warnings
						PW Modify Password

Key	
Identifying colours	Modification of parameters in multi-pump assemblies
	Set of sensitive parameters. These parameters must be aligned so that the multi-pump system can start. The modification of one of these on any devices results in automatic alignment on all the other devices without any question.
	Parameters of which the alignment is allowed in facilitated mode by only one device, broadcasting it to all the others. It is tolerated that they may be different from one device to another.
	Setting parameters that are significant only locally.
	Read-only parameters.

Table 8: Menu structure

6.2 - Access by name with a drop-down menu

The selection of the various menus is accessed by name. From the main menu you access menu selection by pressing either of the + or – keys.

The names of the menus that can be accessed appear on the menu selection page and one of the menus is highlighted by a bar (see Figure 14). Shift the highlighting bar using the + and – keys to select the menu you want and enter it by pressing MODE.

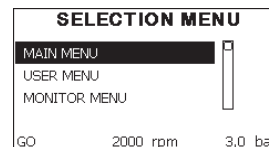

Figure 13: Selection of the drop-down menus

The items available are MAIN, USER, MONITOR, followed by a fourth item, EXTENDED MENU; this item allows the number of menus displayed to be extended. When EXTENDED MENU is selected a pop-up appears asking you to type in an access key (PASSWORD). The access key (PASSWORD) coincides with the combination of keys used for direct access (as in Table 8) and allows the extended display of the menus from the menu corresponding to the access key to all those with a lower priority. The order of the menus is: User, Manual Setpoint, Manual, Installer, Technical Assistance.

When an access key is selected, the menus released remain available for 15 minutes or until they are disabled manually by means of the item “Hide forward menu” which appears on the menu selection when using an access key.

Figure 14 shows an operating diagram for selecting the menus.

The menus are in the centre of the page, from the right you reach them by means of direct selection with a combination of keys, while from the left you reach them by means of the selection system with drop-down menu.

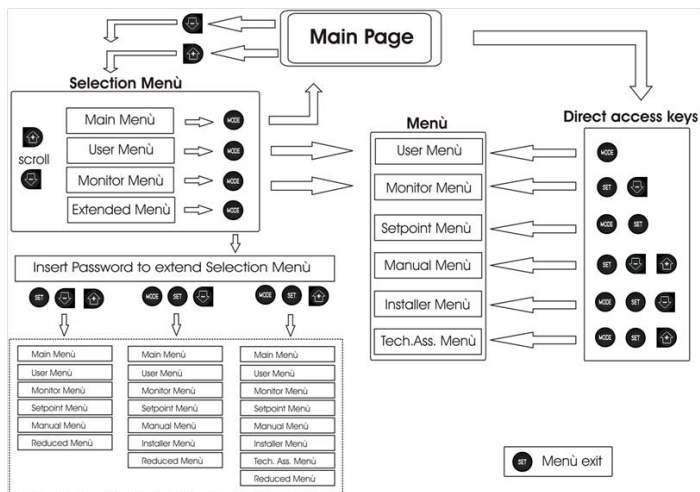

Figure 14: Diagram of possible menu accesses

6.3 - Structure of the menu pages

When switched on, some presentation pages are displayed showing the name of the product and the logo, after which the main menu appears. The name of each menu, whichever it may be, is always at the top of the display.

The following always appear on the main page:

- Status: operating status (e.g. standby, go, Fault, input functions)
- Revs_per_minute: value in [rpm]
- Pressure: value in [bar] or [psi] depending on the set unit of measure.
- Power: value in [kW] of the power absorbed by the device.

If the case occurs the following may appear:
Fault indications
Warning indications
Indications of the functions associated with the inputs
Specific icons

The error conditions are indicated in Table 2. The other displays are indicated in Table 9.

Error or status conditions shown on the main page	
Identifying code	Description
GO	Motor running
SB	Motor stopped
DIS	Motor status manually disabled
F1	Float function status / alarm
F3	System disable function status / alarm
F4	Low pressure signal function status / alarm
P1	Operating status with auxiliary setpoint 1
P2	Operating status with auxiliary setpoint 2
P3	Operating status with auxiliary setpoint 3
P4	Operating status with auxiliary setpoint 4
Com. icon with number	Operating status in multi-pump communication with the address indicated
Com. icon with E	Error status of communication in the multi-pump system
EE	Writing and reading the factory settings on EEPROM
WARN. Low voltage	Warning due to lack of supply voltage

Table 9: Status and error messages on the main page

The other menu pages vary with the associated functions and are described later by type of indication or setting. Once you have entered any menu, the bottom of the page always shows a summary of the main operating parameters (running status or any fault, current speed and pressure). This allows a constant view of the machine's fundamental parameters.



Figure 15: Display of a menu parameter

Indications on the status bar at the bottom of each page	
Identifying code	Description
GO	Motor stopped
SB	Motor stopped
Disable	Motor status manually disabled
rpm	Motor revs per minute
bar	Plant pressure
FAULT	Presence of an error preventing operation of the electropump

Table 10: Indications on the status bar

The following may appear on the pages that show parameters: numerical values and units of measure of the current item, values of other parameters linked to the setting of the current item, graphic bar, lists; see Figure 15.

6.4 - Blocking parameter setting by Password

The device has a password-enabled protection system. If a password is set, the parameters of the device will be accessible and visible but it will not be possible to change them.

The password management system is in the “technical assistance” menu and is managed by means of the parameter PW

6.5 - Enabling and disabling the motor

In normal operating conditions, pressing and then releasing both the “+” and “-” keys causes the blocking/release of the motor (self-holding even after switching off). If there is a fault alarm, the operation described above resets the alarm.

When the motor is disabled this status is shown by the blinking white LED. This command can be activated from any menu page except RF and PW.

7 - MEANING OF THE INDIVIDUAL PARAMETERS

7.1 - User Menu

From the main menu, pressing the MODE key (or using the selection menu and pressing + o -), gives access to the USER MENU. In the menu the MODE key allows you to scroll through the various menu pages. The values shown are the following.

7.1.1 - Status:

Displays the pump status.

7.1.2 - RS: Rotation speed display

Motor rotation speed in rpm.

7.1.3 - VP: Pressure display

Plant pressure measured in [bar] or [psi] depending on the measuring system used.

7.1.4 - VF: Flow display

Displays the instantaneous flow in [litres/min] or [gal/min] depending on the set measuring system.

7.1.5 - PO: Absorbed power display

Power absorbed by the electropump in [kW].

A flashing round symbol may appear under the symbol of the measured power PO. This symbol indicates the pre-alarm for exceeding the allowed maximum power

7.1.6 - C1: Phase current display

Motor phase current in [A].

A flashing round symbol may appear under the symbol of the phase current C1. This symbol indicates the pre-alarm for exceeding the allowed maximum current. If it flashes at regular intervals it means that the motor overload protection is about to trip and it will very probably go into protection status

7.1.7 - Operating hours and number of starts

Indicates on three lines the hours that the device has been powered up, the pump working hours and the number of starts of the motor.

7.1.8 - PI: Power histogram

A histogram of the power delivered is displayed on 5 vertical bars. The histogram indicates how long the pump has been on at a given power level. On the horizontal axis are the bars at the various power levels; on the vertical axis, the time for which the pump has been on at the specific power level (% of the time with respect to the total).



Figura 16: Power histogram display

7.1.9 - Multi-pump system

Displays the system status when in the presence of a multi-pump installation. If communication is not present, an icon depicting communication absent or interrupted is displayed. If there are several devices connected to one another, an icon is shown for each of them. The icon has the symbol of a pump under which are characters indicating the pump status. Depending on the operating status it will display as in Table 11.

System display		
Status	Icon	Status information under the icon
Motor running	Symbol of pump turning	speed in three figures
Motor stopped	Symbol of static pump	SB
Device faulty	Symbol of static pump	F

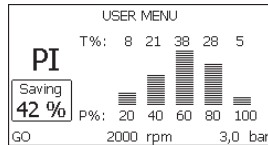
Table 11: View of the multi-pump system

If the device is configured as reserve the icon depicting the pump is dark in colour, the display remains similar to Table 8 with the exception that, if the motor is stopped, it shows F instead of SB.

7.1.10 - Output flow meter

The page shows two flow meters. The first shows the total output flow delivered by the machine. The second shows a partial count and can be reset by the user.

The partial count can be reset from this page, by holding down the “ - ” button for 2 sec.

7.1.11 - VE: Version display

Hardware and software version with which the appliance is equipped.

Hardware and software 5.9.0 and later, the following also applies: on this page after the prefix S: the last 5 figures of the single serial number attributed for connectivity are showed. The whole serial number can be viewed by pressing the “+” key.

7.1.12- FF: Fault log display

Chronological display of the faults that have occurred during system operation.

Under the symbol FF appear two numbers x/y indicating respectively the fault displayed and the total number of faults present; to the right of these numbers is an indication of the type of fault displayed.

The + and – keys scroll through the list of faults: pressing the – key goes back through the log and stops at the oldest fault present, pressing the + key goes forward in the log and stops at the most recent fault.

The faults are displayed in chronological order starting from the one that appeared farthest back in time x=1 to the most recent x=y. The maximum number of faults that can be shown is 64; when that number is reached, the log starts to overwrite the oldest ones.

This item on the menu displays the list of faults, but does not allow reset. Reset can be carried out only with the dedicated control from item RF on the TECHNICAL ASSISTANCE MENU.

The fault log cannot be deleted with a manual reset, by switching off the appliance, or by resetting the factory values, unless the procedure described above has been followed.

7.2 - Monitor Menu

From the main menu, by holding down simultaneously for 2 sec the keys “SET” and “-” (minus), or using the selection menu and pressing + or -, you can access the MONITOR MENU.

In this menu, by pressing the MODE key, the following values are displayed in sequence

7.2.1 - CT: Display contrast

Adjusts the display contrast.

7.2.2 - BK: Display brightness

Adjusts the backlighting of the display on a scale from 0 to 100.

7.2.3 - TK: Backlight switch-on time

Sets the time that the backlight is lit since the last time a key was pressed. Values allowed: ‘0’ always off; from 20 sec to 10 min or ‘always on’.

When the backlight is off, the first time any key is pressed has the sole effect of restoring the backlighting.

7.2.4 - LA: Language

Display in one of the following languages:

- Italian
- English
- French
- German
- Spanish
- Dutch
- Swedish
- Turkish
- Slovak
- Romanian
- Russian
- Thai

7.2.5 - TE: Dissipator temperature display

7.3 - Setpoint Menu

From the main menu, hold down simultaneously the “MODE” and “SET” keys until “SP” appears on the display (or use the selection menu pressing + or -). The + and – keys allow you respectively to increase and decrease the plant boosting pressure.

Press SET to leave this menu and return to the main menu.

The adjustment range is 1-6 bar (14-87 psi).

7.3.1 - SP: Setting the setpoint pressure

Pressure at which the plant is pressurised if there are no active auxiliary pressure regulating functions.

7.3.2 - Setting the auxiliary pressures

The device has the possibility of varying the setpoint pressure according to the status of the inputs, up to 4 auxiliary pressures can be set for a total of 5 different setpoints. For the electrical connections refer to the control unit manual; for the software settings see paragraph 7.6.15.3 - Setting the auxiliary point input function.



If several auxiliary functions associated with several inputs are active at the same time, the device will set the lowest pressure of all the active ones.



The auxiliary setpoints can be used only through the control unit.

7.3.2.1 - P1: Setting the auxiliary setpoint 1

Pressure at which the system is pressurised if the auxiliary setpoint function is activated on input 1.

7.3.2.2 - P2: Setting the auxiliary setpoint 2

Pressure at which the system is pressurised if the auxiliary setpoint function is activated on input 2.

7.3.2.3 - P3: Setting the auxiliary setpoint 3

Pressure at which the system is pressurised if the auxiliary setpoint function is activated on input 3.

7.3.2.4 - P4: Setting the auxiliary setpoint 4

Pressure at which the system is pressurised if the auxiliary setpoint function is activated on input 4.



The pump restarting pressure is linked not only to the set pressure (SP, P1, P2, P3, P4) but also to RP. RP expresses the decrease in pressure, with respect to "SP" (or to an auxiliary setpoint if activated), caused by the pump starting.

For example:

SP = 3,0 [bar]; RP = 0,5 [bar]; no active auxiliary setpoint function-

During normal operation the system is pressurised at 3.0 [bar].

The electropump restarts when the pressure falls below 2.5 [bar].



Setting a pressure (SP, P1, P2, P3, P4) that is too high for the pump performance may cause false water lack errors BL; in these cases lower the set pressure.

7.4 - Manual Menu

From the main menu, hold down simultaneously the "SET" and "+" and "-" keys until the manual menu page appears (or use the selection menu pressing + or -).

The menu allows you to view and modify various configuration parameters: the MODE key allows you to scroll through the menu pages, the + and - keys allow you respectively to increase and decrease the value of the parameter concerned. Press SET to leave this menu and return to the main menu.

Entering the manual menu by pressing the SET + - keys puts the machine into forced STOP condition. This function can be used to force the machine to stop.

In the main menu, irrespective of the parameter displayed, it is always possible to perform the following controls:

Temporary starting of the electropump.

Pressing the MODE and + keys at the same time causes the pump to start at speed RI and this running status remains as long as the two keys are held down.

When the pump ON of pump OFF command is given, a communication appears on the display.

Starting the pump

Holding down the MODE - + keys simultaneously for 2 sec. causes the pump to start at speed RI. The running status remains until the SET key is pressed. The next time the SET key is pressed the pump leaves the manual menu.

When the pump ON of pump OFF command is given, a communication appears on the display.

In case of operation in this mode for more than 5' with no flow of liquid, an alarm overheating alarm will be triggered, with the error PH shown on the display.

Once the PH error condition is no longer present, the alarm will be reset automatically only. The reset time is 15'; if the PH error occurs more than 6 times consecutively, the reset time increases to 1h. Once it has reset further to this error, the pump will remain in stop status until the user restarts it using the "MODE" "-" "+" keys.

7.4.1 - Status:

Displays the pump status.

7.4.2 - RI: Speed setting

Sets the motor speed in rpm. Allows you to force the number of revolutions at a predetermined value.

7.4.3 - VP: Pressure display

Plant pressure measured in [bar] or [psi] depending on the measuring system used.

7.4.4 - VF: Flow display

Displays the flow in the chosen unit of measure. The measuring unit may be [l/min] or [gal/min] depending on the measuring system used.

7.4.5 - PO: Absorbed power display

Power absorbed by the electropump in [kW].

A flashing round symbol may appear under the symbol of the measured power PO. This symbol indicates the pre-alarm for exceeding the allowed maximum power.

7.4.6 - C1: Phase current display

Motor phase current in [A].

A flashing round symbol may appear under the symbol of the phase current C1. This symbol indicates the pre-alarm for exceeding the allowed maximum current. If it flashes at regular intervals it means that the motor overload protection is about to trip and it will very probably go into protection status.

7.4.7 - RS: Rotation speed display

Motor rotation speed in rpm.

7.4.8 - TE: Dissipator temperature display**7.5 - Installer Menu**

From the main menu, hold down simultaneously the "MODE" and "SET" and "-" keys until the first parameter of the installer menu appears on the display (or use the selection menu pressing + or -). The menu allows you to view and modify various configuration parameters: the MODE key allows you to scroll through the menu pages, the + and - keys allow you respectively to increase and decrease the value of the parameter concerned.

Press SET to leave this menu and return to the main menu.

7.5.1 - RP: Setting the pressure fall to restart

Expresses the fall in pressure with respect to the SP value which causes restarting of the pump.

For example if the setpoint pressure is 3.0 [bar] and RP is 0.5 [bar] the pump will restart at 2.5 [bar].

RP can be set from a minimum of 0.1 to a maximum of 1 [bar]. In particular conditions (for example in the case of a setpoint lower than the RP) it may be limited automatically.

To assist the user, on the RP setting page the actual restarting pressure also appears highlighted under the RP symbol, see Figure 17.



Figura 17: Setting the restart pressure

7.5.2 - OD: Type of plant

Possible values 1 and 2 referring to a rigid system and an elastic system. The device leaves the factory with mode 1 suitable for the majority of systems. In the presence of swings in pressure that cannot be stabilised by adjusting the parameters GI and GP, change to mode 2.

IMPORTANT: The regulating parameters GP and GI also change in the two configurations. In addition the GP and GI values set in mode 1 are stored in a different memory from the GP and GI values set in mode 2. So, for example, when passing to mode 2, the GB value of mode 1 is replaced by the GB value of mode 2 but it is kept and will reappear again when returning to mode 1. The same value shown on the display has a different weight in one mode or in the other because the control algorithm is different.

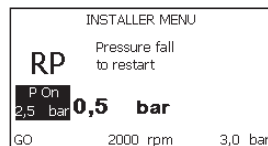
7.5.3 - AD: Address configuration

This is significant only in a multi-pump connection. Set the communication address to be assigned to the device. The possible values are: automatic (default) or manually assigned address.

The addresses set manually can have values from 1 to 4. The configuration of the addresses must be the same for all the devices that make up the group: either all automatic or all manual. Setting the same addresses is not allowed.

Both in the case of assigning mixed addresses (some manual and some automatic) and in the case of duplicate addresses, an error signal is given. The error signal is given by displaying a flashing E in the place of the machine address.

If the chosen assignment is automatic, whenever the system is switched on addresses are assigned that may be different from the previous time, but this does not affect correct operation.

7.5.4 - MS: Measuring system

Set the measuring system, choosing between metric and Anglo-American units. The quantities displayed are shown in Table 12.

NOTE: The flow in Anglo-American-speaking units (gal/min) is indicated adopting a conversion factor of 1 gal = 4.0 litres, corresponding to the metric gallon.

Units of measurement displayed		
Quantity	Metric units	Anglo-American unit
Pressure	bar	psi
Temperature	°C	°F
Flow rate	l / min	gal / min

Table 12: Measuring system

7.5.5 - AS: Association of devices

Allows connection/disconnection with the following devices

- e.sy Other e.sybox pump for operation in a pump set
- composed of max 4 elements
- e.sylink e.sylink input output control unit
- DEV Any other compatible devices

The icons of the various connected devices are displayed on page AS with below an identifying acronym and the respective reception power.

An icon lit with a fixed light means that the device is connected and working correctly; a stroked through icon means the device is configured as part of the network but is not found.



All the devices present over the air are not displayed on this page but only the devices that have been associated with our network.

Seeing only the devices in your own network allows the operation of several similar networks existing within the radius of action of the wireless without creating ambiguity; in this way the user does not see the elements that do not belong to his pumping system.

From this menu page it is possible to associate and disassociate an element from your personal wireless network.

When the machine starts the AS menu item does not show any connection because no device is associated. In these conditions the message "No Dev" is shown and the COMM led is off. Only an action by the operator can allow devices to be added or removed with the operations of association and disassociation.

Association of devices

Pressing '+' for 5 sec puts the machine into the mode where it searches for wireless association, communicating this status by the blinking of the COMM leds at regular intervals. As soon as two machines in a working communication range are put into this status, if possible, they are associated with each other. If the association is not possible for one or both machines, the procedure ends and a pop-up appears on each machine saying "association not possible". An association may not be possible because the device you are trying to associate is already present in the maximum number or because the device to be associated is not recognised. In the last case repeat the procedure from the start.

The search status for association remains active until the device to be associated is detected (irrespective of the result of association); if not device can be seen within the space of 1 minutes, the machine automatically leaves association status. You can leave the search status for wireless association at any time by pressing SET or MODE.

IMPORTANT: Once the association has been made between 2 or more devices, a pop-up appears on the display asking you to extend the configuration. This happens in the case where the devices have different configuration parameters (e.g. setpoint SP, RP etc.). Pressing + on a pump extends the configuration of that pump to the other associated pumps. When the + key is pressed pop-ups appear with the message “Wait...”, and when this message is finished the pumps will start to work regularly with the sensitive parameters aligned; refer to paragraph 9.4.5 for further information.

Disassociation of devices

To dissociate a device belonging to an existing group, go to page AS (installer menu) of the device itself and press the – key for at least 5 seconds. After this operation all the icons related to the connected devices will be replaced the message “No Dev” is shown and the COMM led will remain off.

Replacing devices

To replace a device in an existing group it is sufficient to dissociate the device to be replaced and to associate the new device as described in the procedures above.

If it is not possible to dissociate the element to be replaced (faulty or not available), you will have to carry out the disassociation procedure for each device and create a new group.

7.5.6 - PR: Remote pressure sensor

The PR parameter is used to select a remote pressure sensor.

The default setting is with no sensor present.

In order to execute its intended functions, the remote sensor must be connected to a control unit, which in turn must be associated to the e.sybox, see point 5.1 - Operation with control unit

As soon as a connection is established between the e.sybox and control unit and the remote pressure sensor has been connected, the sensor starts operating. When the sensor is active, the display shows an icon of a stylised sensor with a P inside it.

The remote pressure sensor operates in synergy with the internal sensor so that the pressure never falls below the setpoint pressure in either of the two points in the system (internal and remote sensors). This allows compensation for any pressure drops.

NOTE: in order to maintain the setpoint pressure in the point with lower pressure, the pressure in the other point may be higher than the setpoint pressure.

7.6 - Technical Assistance Menu

Advanced settings to be made only by skilled personnel or under the direct control of the service network.

From the main menu, hold down simultaneously the “MODE” and “SET” keys until “SP” appears on the display (or use the selection menu pressing + or -). The menu allows you to view and modify various configuration parameters: the MODE key allows you to scroll through the menu pages, the + and – keys allow you respectively to increase and decrease the value of the parameter concerned. Press SET to leave this menu and return to the main menu.

7.6.1 - TB: Water lack blockage time

Setting the reaction time of the water lack blockage allows you to select the time (in seconds) taken by the device to indicate the lack of water.

The variation of this parameter may be useful if there is known to be a delay between the moment the motor is switched on and the moment it actually begins to deliver. One example may be a plant where the suction pipe is particularly long and there are some slight leaks. In this case the pipe in question may be discharged and, even though water is not lacking, the electropump will take a certain time to reload, supply the flow and put the plant under pressure.

7.6.2 - T1: Low pressure delay (kiwa function)

Sets the time when the inverter switches off after receiving the low pressure signal (see Setting low pressure detection par. 7.6.15.5). The low pressure

signal can be received on each of the 4 inputs by suitably configuring the input (see Setup of auxiliary digital inputs IN1, IN2, IN3, IN4 par 7.6.15). T1 can be set between 0 and 12 s. The factory setting is 2 s.

7.6.3 - T2: Delay in switching off

Sets the delay with which the inverter must switch off after switch-off conditions have been reached: plant under pressure and flow rate lower than the minimum flow.

T2 can be set between 2 and 120 s. The factory setting is 10 s.

7.6.4 - GP: Proportional gain coefficient

Generally the proportional term must be increased for systems characterised by elasticity (for example with PVC pipes) and lowered in rigid systems (for example with iron pipes).

To keep the pressure in the system constant, the inverter performs a type PI control on the measured pressure error. Depending on this error the inverter calculates the power to be supplied to the motor. The behaviour of this control depends on the set GP and GI parameters. To cope with the different behaviour of the various types of hydraulic plants where the system can work, the inverter allows the selection of parameters different from those set by the factory. For nearly all plants the factory-set GP and GI parameters are optimal. However, should any problems occur in adjustment, these settings may be varied.

7.6.5 - GI: Integral gain coefficient

In the presence of large falls in pressure due to a sudden increase of the flow or a slow response of the system, increase the value of GI. Instead, if there are swings in pressure around the setpoint value, decrease the value of GI.

IMPORTANT: To obtain satisfactory pressure adjustments, you generally have to adjust both GP and GI

7.6.6 - RM: Maximum speed

It sets a maximum limit on the number of pump revolutions.

7.6.7 - Setting the number of devices and of reserves

7.6.8 - NA: Active devices

Sets the maximum number of devices that participate in pumping.

It may have values between 1 and the number of devices present (max 4). The default value for NA is N, that is the number of devices present in the chain; this means that if devices are added to or removed from the chain, NA always has the value of the number of devices present, automatically detected. If a number different from N is set, this fixes the maximum number of devices that can participate in pumping at the number set.

This parameter is used in cases where there is a limit on the pumps you can or want to be able to keep running, and if you want to keep one or more devices as a reserve (see 7.6.10 IC: Configuration of the reserve and other examples below).

On the same menu page you can also see (but not change) the other two system parameters linked to this, that is N, the number of devices present, acquired automatically by the system, and NC, the maximum number of simultaneous devices.

7.6.9 NC: Simultaneous devices

Sets the maximum number of devices that can work at the same time.

It may have values between 1 and NA. The default value of NC is NA, this means that even if NA increases, NC will have the value NA. If a number different from NA is set, this releases you from NA and fixes the maximum number of simultaneous devices at the number set. This parameter is used in cases where there is a limit on the pumps you can or want to be able to keep running (see 7.6.10 IC: Configuration of the reserve and other examples below).

On the same menu page you can also see (but not change) the other two system parameters linked to this, that is N, the number of devices present, read automatically by the system, and NA, the number of active devices.

7.6.10 IC: Configuration of the reserve

Configures the device as automatic or reserve. If set on auto (default) the device participates in normal pumping, if configured as reserves, minimum starting priority is associated with it, this means that the device with this setting will always start last. If a number of active devices is set that is one lower than the number of devices present and if one element is set as re-

serve, the effect obtained is that, if there are no problems, the reserve device does not participate in regular pumping; instead, if one of the devices that participates in pumping develops a fault (maybe loss of power supply, tripping of a protection, etc.), the reserve device will start.

The state of configuration as a reserve can be seen as follows: on the Multi-pump System page, the top of the icon is coloured; on the AD and main pages, the communication icon representing the address of the device appears with the number on a coloured background. There may be more than one device configured as reserve in a pumping system.

Even though the devices configured as reserve do not participate in normal pumping, they are nevertheless kept efficient by the anti-stagnation algorithm. The anti-stagnation algorithm changes the starting priority once every 23 hours and allows the accumulation of at least one continuous minute of supply of flow from each device. The aim of this algorithm is to avoid the deterioration of the water inside the impeller and to keep the moving parts efficient; it is useful for all devices and especially for those configured as reserve, which do not work in normal conditions.

7.6.10.1 - Examples f configuration for multipump systems

Example 1:

A pump set composed of 2 devices (N=2 detected automatically) of which 1 set active (NA=1), one simultaneous (NC=1 or NC=NA since NA=1) and one as reserve (IC=reserve on one of the two devices).

The result obtained is the following: the device not configured as a reserve will start and work by itself (even though it does not manage to bear the hydraulic load and the pressure achieved is too low). If it has a fault, the reserve device steps in.

Example 2:

A pump set composed of 2 devices (N=2 detected automatically) in which all the devices are active and simultaneous (factory settings NA=N and NC=NA) and one as reserve (IC=reserve on one of the two devices). The result obtained is the following: the device that is not configured as reserve always starts first, if the pressure detected is too low the second device, configured as reserve, also starts. In this way we always try to preserve the use of one device in particular (the one configured as reserve), but this may be useful in case of necessity when a greater hydraulic load occurs.

Example 3:

A pump set composed of 4 devices (N=4 detected automatically) of which 3 set active (NA=3), 2 simultaneous (NC=2) and 1 as reserve (IC=reserve on two devices),

The result obtained is the following: at the most 2 devices will start at the same time. The operation of the 2 that can work simultaneously will take place in rotation among 3 devices so as to respect the maximum exchange time of each (ET). If one of the active devices develops a fault no reserve starts up because more than 2 devices cannot start at one time (NC=2) and there are still 2 active devices present. The reserve intervenes as soon as another of the 2 develops a fault.

7.6.11 - ET: Max. switching time

Sets the maximum continuous working time of a device in a set. It is significant only on pump sets with interconnected devices. The time can be set between 1 min and 9 hours; the factory setting is 2 hours.

When the ET of a device has elapsed the system starting order is reassigned so as to give minimum priority to the device on which the time has elapsed. The aim of this strategy is to use less the device that has already worked and to balance the working time between the various machines that make up the set. If the hydraulic load still requires the intervention of the device, even though it has been put last in starting order, it will start to guarantee pressure boosting of the system.

The starting priority is reassigned in two conditions based on the ET time:

1. Exchange during pumping: when the pump remains on without interruption until the absolute maximum pumping time has been exceeded.
2. Exchange to standby: when the pump is on standby but 50% of the ET time has been exceeded.

If ET has been set at 0 there will be exchange to standby. Whenever a pump in the set stops, a different pump will start first next time it is restarted.



If the parameter ET (Max. switching time) is set at 0, there will be exchange at each restart, irrespective of the pump's actual work time.

7.6.12 - AY: Anti Cycling

As described in paragraph 9, this function is for avoiding frequent switching on and off in the case of leaks in the system. The function can be enabled in 2 different modes, normal and smart. In normal mode the electronic control blocks the motor after N identical start/stop cycles. In smart mode it acts on the parameter RP to reduce the negative effects due to leaks. If set on "Disable", the function does not intervene.

7.6.13 - AE: Enabling the anti-block function

This function is for avoiding mechanical blocks in the case of long inactivity; it acts by periodically rotating the pump.

When the function is enabled, every 23 hours the pump performs an unblocking cycle lasting 1 min.

7.6.14 - AF: Enabling the anti-freeze function

If this function is enabled the pump is automatically rotated when the temperature reaches values close to freezing point, in order to avoid breakages of the pump.

7.6.15 - Setup of the auxiliary digital inputs IN1, IN2, IN3, IN4

This paragraph shows the functions and possible configurations of the inputs of the control unit, connected by wireless to the device, by means of the parameters I1, I2, I3, I4. For the electrical connections refer to the control unit manual.

The inputs IN1..IN4 are all the same and all the functions can be associated with each of them. Parameters I1, I2, I3 and I4 are used to associate the function required to the corresponding input (IN1, IN2, IN3 and IN4.).

Each function associated with the inputs is explained in greater detail below in this paragraph. Table 15 sums up the functions and the various configurations.

The factory configurations can be seen in Table 13.

Factory configurations of the digital inputs IN1, IN2, IN3, IN4

Input	Value
1	0 (disable)
2	0 (disable)
3	0 (disable)
4	0 (disable)

Table 13: Factory configurations of the inputs

Table summarising the possible configurations of the digital inputs IN1, IN2, IN3, IN4 and their operation

Value	Function associated to input INx	Display of the active function associated with the input
0	Input functions disabled	
1	Water lack from external float (NO)	Float switch symbol (F1)
2	Water lack from external float (NC)	Float switch symbol (F1)
3	Auxiliary setpoint Pi (NO) for the input used	Px
4	Auxiliary setpoint Pi (NC) for the input used	Px
5	General disabling of motor by external signal (NO)	F3
6	General disabling of motor by external signal (NC)	F3
7	General disabling of motor by external signal (NO) + Reset of resettable blocks	F3
8	General disabling of motor by external signal (NC) + Reset of resettable blocks	F3

9	Reset of resettable blocks NO	
10	Low pressure signal input NO, automatic and manual reset	F4
11	Low pressure signal input NC, automatic and manual reset	F4
12	Low pressure input NO only manual reset	F4
13	Low pressure input NC only manual reset	F4

Table 14: Configurations of the digital inputs

7.6.15.1 - Disabling the functions associated with the input

Setting 0 as the configuration value of an input, each function associated with the input will be disabled irrespective of the signal present on the input terminals.

7.6.15.2 - Setting external float function

The external float can be connected to any input, for the electrical connections refer to the control unit manual.

The float function is obtained, setting one of the values in Table 16 on the parameter Ix, for the input to which the float has been connected.

The activation of the external float function generates the block of the system. The function is conceived for connecting the input to a signal arriving from a float which indicates lack of water.

When this function is active the float switch symbol is shown on the STATUS line of the main page.

For the system to block and give the error signal F1, the input must be activated for at least 1 sec.

When it is in error condition F1, the input must have been deactivated for at least 30 sec before the system can be unblocked. The behaviour of the function is summed up in Table 15.

When several float functions are configured at the same time on different

inputs, the system will indicate F1 when at least one function is activated and will remove the alarm when none is activated.

Behaviour of the external float function depending on INx and on the input				
Value of Parameter Ix	Input configuration	Input status	Operation	Shown on display
1	Active with high signal on input (NO)	Absent	Normal	None
		Present	System block for water lack by external float	F1
2	Active with low signal on input (NC)	Absent	System block for water lack by external float	F1
		Present	Normal	None

Table 15: External float function

7.6.15.3 - Setting auxiliary setpoint input function

The signal that enables an auxiliary setpoint can be supplied on any of the 4 inputs (for the electrical connections, refer to the control unit manual). The auxiliary setpoint is obtained by setting the Ix parameter relating to the input on which the connection has been made, in accordance with Table 17. Example: to use Paux 2, set I2 on 3 or 4 and use input 2 on the control unit; in this condition, if input 2 is energized, pressure Paux 2 will be produced and the display will show P2.

The auxiliary setpoint function modifies the system setpoint from pressure SP (see par. 7.3 – Setpoint Menu) to pressure Pi, where i represents the input used. In this way, as well as SP, four other pressures are available, P1, P2, P3, P4.

When this function is active the symbol Pi is shown on the main page.

For the system to work with the auxiliary setpoint, the input must be active for at least 1 sec.

When you are working with the auxiliary setpoint, to return to working with setpoint SP, the input must not be active for at least 1 sec. The behaviour of the function is summed up in Table 16. When several auxiliary setpoint functions are configured at the same time on different inputs, the system will show Pi when at least one function is activated. For simultaneous activations, the pressure achieved will be the lowest of those with the active input. The alarm is removed when no input is activated.

Behaviour of the auxiliary setpoint function depending on Ix and on the input				
Value of Parameter Ix	Input configuration	Input status	Operation	Shown on display
3	Active with high signal on input (NO)	Absent	i-th auxiliary setpoint not active	None
		Present	i-th auxiliary setpoint active	Px
4	Active with low signal on input (NC)	Absent	i-th auxiliary setpoint active	Px
		Present	i-th auxiliary setpoint not active	None

Table 16: Auxiliary setpoint

7.6.15.4 - Setting system disabling and fault reset

The signal that enables the system can be supplied to any input (for the electrical connections refer to the control unit manual). The system disabling function is obtained by setting the parameter Ix, relating to the input to which the signal to be used to disable the system is connected, on one of the values shown in Table 18.

When the function is active, the system shuts down completely and the F3 symbol appears on the main page.

When several system disabling functions are configured at the same time on different inputs, the system will indicate F3 when at least one function is activated and will remove the alarm when none is activated.

For the system to work with the disable function, the input must be active for at least 1 sec.

When the system is disabled, for the function to be deactivated (re-enabling the system), the input must not be active for at least 1 sec. The behaviour of the function is summed up in Table 17.

When several disable functions are configured at the same time on different inputs, the system will show F3 when at least one function is activated. The alarm is removed when no input is activated.

This function also allows the resetting of any faults present, see table 18.

Behaviour of the system disabling and fault reset function depending on Ix and on the input				
Value of Parameter Ix	Input configuration	Input status	Operation	Shown on display
5	Active with high signal on input (NO)	Absent	Motor enabled	None
		Present	Motor disabled	F3
6	Active with low signal on input (NC)	Absent	Motor disabled	F3
		Present	Motor enabled	None
7	Active with high signal on input (NO)	Absent	Motor enabled	None
		Present	Motor disabled + fault reset	F3
8	Active with low signal on input (NC)	Absent	Motor disabled + fault reset	F3
		Present	Motor enabled	None
9	Active with high signal on input (NO)	Absent	Motor enabled	None
		Present	Fault reset	None

Table 17: Disabling system restore and fault

7.6.15.5 - Setting low pressure detection (KIWA)

The minimum pressure switch that detects low pressure can be connected to any input (for the electrical connections refer to the control unit manual). The system disabling function is obtained by setting the parameter Ix relating to the input to which the signal to be used to disable the system is connected on one of the values shown in Table 17.

The activation of the low pressure detecting function generates the blocking of the system after the time T1 (see par. 7.6.2 - **T1: Low pressure delay**). The function has been conceived to connect the input to the signal arriving from a pressure switch which indicates too low a pressure on the pump intake.

When this function is active the symbol F4 is shown on the main page.

Tripping of this function causes the pump to cut out; it may be reset automatically or manually. For automatic reset of the F4 error condition, the input must be deactivated for at least 2 sec. before the system resets.

To reset the cut-out in manual mode, press and then release the “+” and “-” keys simultaneously

The behaviour of the function is summed up in Table 18.

When low pressure detection functions are configured at the same time on different inputs, the system will indicate F4 when at least one function is activated and will remove the alarm when none is activated.

Response of low pressure detection function (KIWA) according to Ix and input				
Value of Parameter Ix	Input configuration	Input status	Operation	Shown on display
10	Active with high signal on input (NO)	Absent	Normal	None
		Present	Block of system for low pressure on intake, Automatic + Manual reset	F4

11	Active with low signal on input (NC)	Absent	Block of system for low pressure on intake, Automatic + Manual reset	F4
		Present	Normal	None
12	Attivo con segnale alto sull'ingresso (NO)	Absent	Normal	None
		Present	Block of system for low pressure on intake. Manual reset only.	F4
13	Attivo con segnale basso sull'ingresso (NC)	Absent	Block of system for low pressure on intake. Manual reset only.	F4
		Present	Normal	None

Table 18: Detecting the low pressure signal (KIWA)

7.6.16 - Setup of the outputs OUT1, OUT2

This section shows the functions and possible configurations of outputs OUT1 and OUT2 of the I/O control unit, with wireless connection to the device, set by means of parameters O1 and O2.

For the electrical connections, refer to the control unit manual.

The factory configurations can be seen in Table 19.

Factory configurations of the outputs	
Uscita	Value
OUT 1	2 (fault NO closes)
OUT 2	2 (Pump running NO closes)

Table 19: Factory configurations of the outputs

7.6.17 - O1: Setting output 1 function

Output 1 communicates an active alarm (it indicates that a system block has occurred). The output allows the use of a normally open clean contact.

The values and functions indicated in Table 21 are associated with the parameter O1.

7.6.18 - O2: Setting output 2 function

Output 2 communicates the motor running status. The output allows the use of a normally open clean contact.

The values and functions indicated in Table 20 are associated with the parameter O2.

Configuration of the functions associated with the outputs				
Output configuration	OUT1		OUT2	
	Activation condition	Output contact status	Activation condition	Output contact status
0	No associated function	Contact always open	No associated function	Contact always open
1	No associated function	Contact always closed	No associated function	Contact always closed
2	Presence of blocking errors	In the case of blocking errors the contact closes	Output activation in case of blocking errors	When the motor is running the contact closes
3	Presence of blocking errors	In the case of blocking errors the contact opens	Output activation in case of blocking errors	When the motor is running the contact opens

Table 20: Configuration of the outputs

7.6.19 FW: Firmware update

This menu page allows you to update the e.sybox firmware. For the procedure see chapter 11.

7.6.20 - RF: Fault and warning reset

Holding down the + and – keys together for at least 2 seconds deletes the history of faults and warnings. The number of faults present in the log is indicated under the symbol RF (max 64).

The log can be viewed from the MONITOR menu on page FF.

7.6.21 - PW: Change password

The device has a password-enabled protection system. If a password is set, the parameters of the device will be accessible and visible but it will not be possible to change them.

When the password (PW) is "0" all the parameters are unlocked and can be edited.

When a password is used (value of PW different from 0) all modifications are blocked and "XXXX" is displayed on the page PW.

If the password is set it allows to navigate through all the pages, but at any attempt to edit a parameter a pop-up appears, asking you to type in the password. When the correct password is typed in the parameters are unlocked and can be edited for 10' after the last key is pressed.

If you want to cancel the password timer, just go to page PW and hold down + and – together for 2'.

When the correct password is typed in a padlock is shown opening, while if the wrong password is given a flashing padlock appears.

After resetting the factory values the password is set back at "0".

Each change of the password takes effect when Mode or Set is pressed and each subsequent change of a parameter implies typing in the new password again (e.g. the installer makes all the settings with the default PW value = 0 and lastly sets the PW so as to be sure that the machine is already protected without any further action).

If the password is lost there are 2 possibilities for editing the parameters of the device:

- Make a note of the values of all the parameters, reset the device with the factory values, see paragraph 8.3. The reset operation cancels all the parameters of the device, including the password.

- Make a note of the number present on the password page, send a mail with this number to your service centre, in a few days you will be sent the password to unlock the device.

7.6.21.1 - Password for multipump systems

When the PW is typed in to unlock a device in a set, all the devices are unlocked.

When the PW is changed on a device in a set, all the devices receive the change.

When activating protection with a PW on a device in a set (+ and – on page PW when PW≠0), the protection is activated on all the devices (to make any change you are asked for the PW).

8 - RESET AND FACTORY SETTINGS

8.1 - General system reset

To reset the system, hold down the 4 keys simultaneously for 2 sec. This operation is the same as disconnecting the power, waiting for it to close down completely and supplying power again. The reset does not delete the settings saved by the user.

8.2 - Factory settings

The device leaves the factory with a series of preset parameters which may be changed according to the user's requirements. Each change of the settings is automatically saved in the memory and, if desired, it is always possible to restore the factory conditions (see Restoring the factory settings par 8.3 – Restoring the factory settings).

8.3 - Restoring the factory settings

To restore the factory values, switch off the device, wait until the display has switched off completely, press and hold down the "SET" and "+" keys and turn on the power; release the two keys only when the letters "EE" appear.

This restores the factory settings (a message and a rereading on EEPROM of the factory settings permanently saved in the FLASH memory).

Once all the parameters have been set, the device returns to normal operation.

NOTE: Once the factory values have been restored it will be necessary to reset all the parameters that characterise the system (gains, setpoint pressure, etc.) as at the first installation.

Factory settings			
Identifying code	Description	Value	Installation Memo
TK	Backlight lighting T	2 min	
LA	Language	ENG	
SP	Setpoint pressure [bar]	3,0	
P1	Setpoint P1 [bar]	2,0	
P2	Setpoint P2 [bar]	2,5	
P3	Setpoint P3 [bar]	3,5	
P4	Setpoint P4 [bar]	4,0	
RI	Revs per minute in manual mode [rpm]	2400	
OD	Type of plant	1 (Rigid)	
RP	Pressure decrease to restart [bar]	0,3	
AD	Address configuration	0 (Auto)	
PR	Remote pressure sensor	Disable	
MS	Measuring system	0 (International)	
TB	Blockage time for water lack [s]	15	
T1	Low pr. delay (KIWA) [s]	2	
T2	Delay in switching off [s]	10	
GP	Proportional gain coefficient	0,5	
GI	Integral gain coefficient	1,2	
RM	Maximum speed [rpm]	3050	

NA	Active devices	N	
NC	Simultaneous devices	NA	
IC	Configuration of the reserve	1 (Auto)	
ET	Max. switching time [h]	2	
AE	Anti-blocking function	1(Enable)	
AF	Antifreeze	1(Enable)	
I1	Function I1	0 (Disable)	
I2	Function I2	0 (Disable)	
I3	Function I3	0 (Disable)	
I4	Function I4	0 (Disable)	
O1	Function output 1	2	
O2	Function output 2	2	
PW	Change Password	0	
AY	Anticycling Function AY	0 (Disabled)	

Table 21: Factory settings

9 - PARTICULAR INSTALLATIONS

9.1 - Inhibiting self-priming

The product is made and supplied with the capacity of being self-priming. With reference to par. 6, the system is able to prime and therefore operate in whatever installation configuration chosen: below head or above head. However there are cases in which the self-priming capacity is not necessary, or areas where it is forbidden to use self-priming pumps. During priming the pump obliges part of the water already under pressure to return to the suction part until a pressure value is reached at delivery whereby the system can be considered primed. At this point the recirculating channel closes automatically. This phase is repeated each time the pump is switched on, even already primed, until the same pressure value that closes the recirculating channel is reached (about 1 bar).

When the water arrives at the system intake already under pressure (maximum allowed 2 bar) or when the installation is always below head, it is possible (and mandatory where local regulations require it) to force the closure of the recirculating pipe, losing the self-priming capacity. This obtains the advantage of eliminating the clicking noise of the pipe shutter each time the system is switched on.

To force closure of the self-priming pipe, proceed as follows:

1. disconnect the power supply;
2. empty the system (unless you decide to inhibit self-priming at the first installation);
3. remove the drainage cap anyway, taking care not to drop the O-ring (Fig.18);
4. with the aid of pliers take the shutter out of its seat. The shutter will be extracted together with the O-Ring and the metal spring with which it is assembled;
5. remove the spring from the shutter; insert the shutter in its seat again with the respective O-Ring (side with gasket towards the inside of the pump, stem with cross-shaped fins towards the outside);
6. screw on the cap after having positioned the metal spring in side so that it is compressed between the cap itself and the with cross-shaped fins of the shutter stem. When repositioning the cap ensure that the respective O-Ring is always correctly in its seat.

7. fill the pump, connect the power supply, start the system.

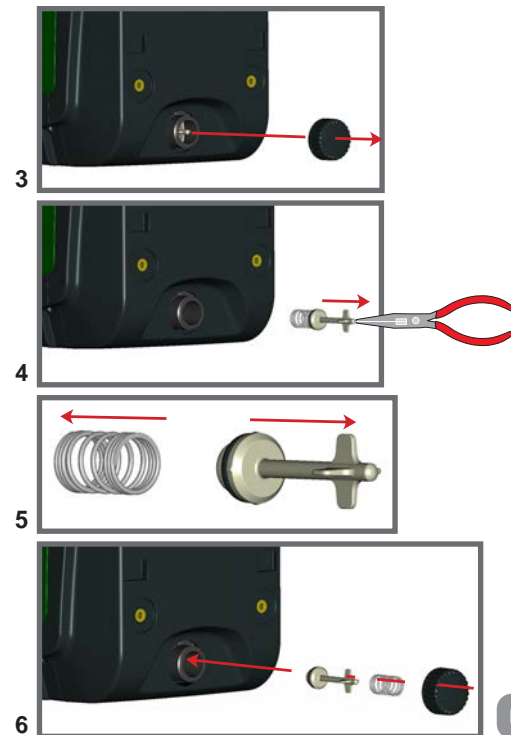

Figure 18

9.2 - Wall installation

This product is already set up for installation hanging on the wall with the DAB accessory kit, to be purchased separately. The wall installation appears as in Fig.19.



Figure 19

9.3 - Installation with quick connection

DAB supplies an accessory kit for Quick Connection of the system. This is a quick coupling base on which to make the connections to the plant and from which the system can be simply connected or disconnected.

Advantages:

- possibility of making up the plant on-site, testing it, but removing the actual system until the moment of delivery, avoiding possible damage (accidental blows, dirt, theft, ...);
- it is easy for the Assistance service to replace the system with a "spare" in the event of special maintenance.

The system mounted on its quick connection interface appears as in Fig.20.



Figure 20

9.4 - Multiple Sets

9.4.1 - Introduction to multipump systems

By multipump systems we mean a pump set made up of a number of pumps whose deliveries all flow into a common manifold. The devices communicate with one another by means of the connection provided (wireless).

The group may be made up of a maximum of 4 devices.

A multipump system is used mainly for:

- Increasing hydraulic performance in comparison with a single device.
- Ensuring continuity of operation in the event of a device developing a fault.
- Sharing out the maximum power.

9.4.2 - Making a multipump system

The hydraulic plant must be created as symmetrically as possible to obtain a hydraulic load uniformly distributed over all the pumps.

The pumps must all be connected to a single delivery manifold:



For good operation of the pressure boosting set, the following must be the same for each device:

- hydraulic connections
- maximum speed (parameter RM)

The firmware of the connected e.sybox units must all be the same. Once the hydraulic system has been made, it is necessary to create the pumping set by carrying out the wireless association of the devices (see par 7.5.5.)

9.4.3 - Wireless communication

The devices communicate with each other and send the flow and pressure signals by wireless communication.

9.4.4 - Connection and setting of the inputs

The inputs of the I/O control unit are used to activate the float, auxiliary setpoint, system disabling and low suction pressure functions. The functions are indicated respectively by the float switch (F1), Px, F3 and F4 symbols. If activated, the Paux function boosts the pressure in the system to the set pressure see par. 7.6.15.3 - Setting auxiliary setpoint input function. The functions F1, F3, F4 stop the pump for 3 different reasons, see par 7.6.15.2, 7.6.15.4, 7.6.15.5.

The parameters for setting the inputs I1, I2, I3, I4 are part of the sensitive parameters, so setting one of these on any device means that they are automatically aligned on all the devices.

Parameters linked to multipump operation

The parameters shown on the menu for multipump operation are classified as follows:

- Read-only parameters.
- Parameters with local significance.
- Multipump system configuration parameters
which in turn are divided into:
 - Sensitive parameters
 - Parameters with optional alignment

9.4.5 Parameters concerning multipump

Parameters with local significance

These are parameters that can be divided among the various devices and in some cases it is necessary for them to be different. For these parameters it is not allowed to align the configuration automatically among the various devices. For example, in the case of manual assignment of the addresses, these must absolutely be different one from the other.

List of parameters with local significance for the device:

- CT Contrast
- BK Brightness
- TK Backlight switch-on time
- RI Revs/min in manual mode
- AD Address Configuration
- IC Reserve configuration
- RF Reset fault and warning
- PW Set Password

Sensitive parameters

These are parameters which must necessarily be aligned over the whole chain for adjustment reasons.

List of sensitive parameters:

- SP Setpoint pressure
- P1 Auxiliary setpoint input 1
- P2 Auxiliary setpoint input 2
- P3 Auxiliary setpoint input 3
- P4 Auxiliary setpoint input 4
- RP Pressure decrease to restart
- ET Exchange time
- AY Anticycling
- NA Number of active devices
- NC Number of simultaneous devices
- TB Dry run time
- T1 Switch-off time after low pressure signal
- T2 Switch-off time

- GI Integral gain
- GP Proportional gain
- I1 Input 1 setting
- I2 Input 2 setting
- I3 Input 3 setting
- I4 Input 4 setting
- OD Type of system
- PR Remote pressure sensor
- PW Change password

Automatic alignment of sensitive parameters

When a multipump system is detected, the compatibility of the set parameters is checked. If the sensitive parameters are not aligned among all the devices, a message appears on the display of each device asking whether you want to propagate the configuration of that particular device to the whole system. If you accept, the sensitive parameters of the device on which you answered the question will be distributed to all the devices in the chain.

If there are configurations that are not compatible with the system, these devices are not allowed to propagate their configuration.

During normal operation, changing a sensitive parameter of a device results in the automatic alignment of the parameter on all the other devices without asking for confirmation.

NOTE: *The automatic alignment of the sensitive parameters has no effect on all the other types of parameters.*

In the particular case of inserting a device with factory settings in the chain (a device replacing an existing one or a device on which the factory configuration has been restored), if the present configurations with the exception of the factory configurations are compatible, the device with factory configuration automatically assumes the sensitive parameters of the chain.

Parameters with optional alignment

These are parameters for which it is tolerated that they may not be aligned among the various devices. At each change of these parameters, when you come to press SET or MODE, you are asked if you want to propagate the change to the entire communication chain. In this way, if all elements of the chain are the same, it avoids setting the same data on all the devices

List of parameters with optional alignment:

- LA Language
- MS Measuring system
- AE Anti-blocking
- AF AntiFreeze
- O1 Function output 1
- O2 Function output 2
- RM Maximum speed

9.4.6 First start of the multipump system

Make the electric and hydraulic connections of the whole system as described in par 2.1.1, 2.2.1 and par 3.1.

Switch on the devices and create the associations as described in paragraph 7.5.5 – AS: Association of devices.

9.4.7 Multipump adjustment

When a multipump system is switched on, the addresses are automatically assigned and an algorithm selects one device as the adjustment leader. The leader decides the speed and starting order of each device in the chain.

The adjustment mode is sequential (the devices start one at a time). When starting conditions occur, the first device starts, when it has reached maximum speed the next one starts, and then the others in sequence. The starting order is not necessarily in ascending order according to the machine address, but it depends on the working hours done see 7.6.11 - ET: Max. switching time

9.4.8 - Assigning the starting order

Each time the system is switched on a starting order is associated with each device. Depending on this, the sequential starts of the devices are decided.

The starting order is modified during use as necessary by the following two algorithms:

- Reaching the Max. switching time
- Reaching the maximum inactivity time

9.4.9 - Max. switching time

Depending on the parameter ET (Max. switching time), each device has a working time counter, and depending on this the starting order is updated with the following algorithm:

- if at least half of the ET value has been exceeded, the priority is exchanged the first time the inverter switches off (exchange to standby);
- if the ET value is reached without ever stopping, the inverter is switched off unconditionally and is taken to minimum restarting priority (exchange during running).



If the parameter ET (Max. switching time) is set at 0, there is an exchange at each restart.

See 7.6.11 - ET: Max. switching time.

9.4.10 - Reaching the maximum inactivity time

The multipump system has an anti-stagnation algorithm, the aim of which is to keep the pumps in perfect working order and to maintain the integrity of the pumped fluid. It works by allowing a rotation in the pumping order so as to make all the pumps supply at least one minute of flow every 23 hours. This happens whatever the device configuration (enabled or reserve). The exchange of priority requires that the device that has been stopped for 23 hours be given maximum priority in the starting order. This means that as soon as it is necessary to supply flow, it will be the first to start. The devices configured as reserve have precedence over the others. The algorithm ends its action when the device has supplied at least one minute of flow. When the intervention of the anti-stagnation algorithm is over, if the device

is configured as reserve, it is returned to minimum priority to preserve it from wear.

9.4.11 - Reserves and number of devices that participate in pumping

The multipump system reads how many elements are connected in communication and calls this number N.

Then depending on the parameters NA and NC it decides how many and which devices must work at a certain time.

NA represents the number of devices that participate in pumping. NC represents the maximum number of devices that can work at the same time.

If there are NA active devices in a chain and NC simultaneous devices with NC smaller than NA, it means that at the most NC devices will start at the same time and that these devices will exchange with NA elements. If a device is configured with reserve preference, it will be the last in the starting order, so for example if I have 3 devices and one of these is configured as reserve, the reserve will be the third element to start, whereas if I set NA=2 the reserve will not start unless one of the two active ones develops a fault.

See also the explanation of the parameters

7.6.8 - NA: Active devices;

7.6.9 NC: Simultaneous devices;

7.6.10 IC: Configuration of the reserve.

In the DAB catalogue there is a Kit for the integrated creation of a booster set of 2 systems. The booster made with the DAB kit appears as in Fig.21



Figura 21

9.4.12 - Wireless Control

As described in par. 9.4.3, the device can be connected to other devices by means of the proprietary wireless channel. There is therefore the possibility of controlling particular operations of the system through signals received in remote mode: for example, depending on a tank level supplied by a float it is possible to order it to be filled; with the signal arriving from a timer it is possible to vary the setpoint from SP to P1 to supply irrigation; These signals entering or leaving the system are managed by a control unit that can be bought separately from the DAB catalogue.

10. MAINTENANCE



Disconnect the power supply before starting any work on the system.

The system requires no routine maintenance operations.

However, below are the instructions for performing the special maintenance operations that may be necessary in particular cases (e.g. emptying the system to put it away during a period of inactivity).

10.1 - Accessory tool

With the product DAB supplies an accessory tool that is useful for carrying out the operations contemplated on the system during installation and any special maintenance operations.

The tool is housed in the technical compartment. It is composed of 3 keys:

- 1 - metal key with a hexagonal section (Fig.22 – 1);
- 2 - flat plastic key (Fig.22 – 2);
- 3 - cylindrical plastic key (Fig.22 – 3).

Key “1” is in turn inserted in the end “D” of key “3”. At the first use you must separate the 2 plastic keys “2” and “3”, which are supplied joined by a bridge (Fig.22 – A):



break the bridge “A”, taking care to remove the cutting residue from the 2 keys so as not to leave any sharp bits that could cause injuries.

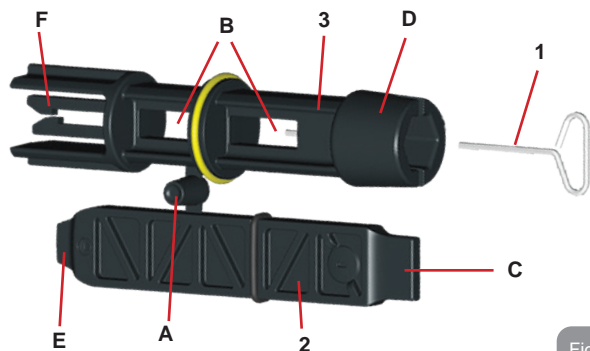

Figure 22

Use the key "1" for the orientation of the interface panel as described in par 2.2.2. If the key is lost or damaged, the operation can be done using a standard 2mm allen wrench.

Once the 2 plastic keys have been separated they can be used by inserting "2" in one of the holes "B" in key "3": whichever hole is most convenient, depending on the operation. At this point you obtain a multifunction cross key, with a use corresponding to each of the 4 ends.



Figure 23



To use the cross key you must put the unused key "1" away in a safe place so that it does not get lost, or else put it back in its seat inside key "3" at the end of operations.

Use of end "C":

this is practically a straight tip screwdriver of the correct size for manoeuvring the caps of the main connections of the system (1" and 1"1/4). To be used at the first installation to remove the caps from the mouths on which you want to connect the system; for the filling operation in the case of horizontal installation; to access the non-return valve, ... If the key is lost or damaged, the same operations can be performed using a straight tip screwdriver of a suitable size.



Figure 24



Figura 25

Use of end "D":

hexagonal socket head suitable for removing the cap to perform filling in the case of vertical installation. If the key is lost or damaged, the same.

Use of end "E":

this is practically a straight tip screwdriver of the correct size for manoeuvring the motor shaft access cap and, if the interface for quick connection of the system has been installed (par. 15.3), for access to the key for disengaging the connection. If the key is lost or damaged, the same operations can be performed using a straight tip screwdriver of a suitable size.



Figura 26

Use of end "F":

the function of this tool is dedicated to maintenance of the non-return valve and it is better described in the respective paragraph 10.3.

10.2 - Emptying the system

If you want to drain the water out of the system, proceed as follows:

1. disconnect the power supply;
2. turn on the delivery tap closes to the system so as to remove pressure from the system and empty it as much as possible;
3. if there is a check valve immediately downstream from the system (always recommended), close it so as not to let out the water that is in the plant between the system and the first turned on tap;
4. interrupt the suction pipe in the point closest to the system (it is always recommended to have a check valve immediately upstream from the system) so as not to drain the whole suction system;
5. remove the drainage cap (fig.1 face E) and let out the water inside (about 2.5 litres);
6. the water that is trapped in the delivery system downstream from the non-return valve integrated in the system can flow out at the time of disconnecting the system, or on removing the cap of the second delivery (if not used).



Though essentially drained, the system is unable to expel all the water that it contains.

During handling of the system after emptying it, some small amounts of water may probably leak out from the system.

10.3 - Non-return valve

The system has an integrated non-return valve which is necessary for correct operation. The presence of solid bodies or sand in the water could cause malfunctioning of the valve and therefore of the system. Although it is recommended to use fresh water and eventually fit filters on input, if you notice abnormal operation of the non-return valve it can be extracted from the system and cleaned and/or replaced by proceeding as follows:

1. remove the valve access cap (Fig.27);
2. insert the accessory cross key in end "F" (par. 10.1) so as to catch the perforated tab with the hooks (Fig.27);
3. extract without rotating: the operation may require a certain effort. A cartridge is extracted which also holds the valve to be serviced. The cartridge remains on the key (Fig.27);
4. disengage the cartridge from the key: the hooks are released by pushing the cartridge and the key against each other, at this point slip the cartridge off the side (Fig.27);
5. clean the valve under running water, ensure that it is not damaged and replace it if necessary;
6. put the complete cartridge back in its seat: the operation requires the force necessary to compress the 2 O-rings. If necessary, use end "D" of the cross key to help you push. Do not use end "F" or the hooks will again engage the tab of the cartridge and it will be impossible to release them (Fig.27);
7. Screw on the cap till snug: if the cartridge has not been pushed correctly in place, screwing on the cap will complete its positioning (Fig.27).



Figura 27



Due to the cartridge remaining in its seat for a long time and/or to the presence of sediment, the force needed to extract the cartridge might be such as to damage the accessory tool. In this case it is intentional, because it is preferable to damage the tool

rather than the cartridge. If the key is lost or damaged, the same operation can be performed with pliers.

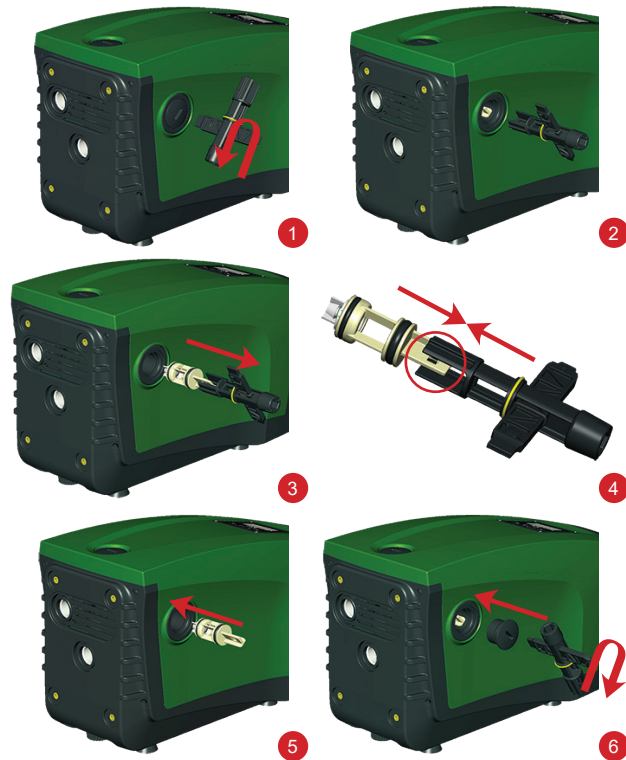

Should one or more O-rings be lost or damaged during maintenance operations on the non-return valve, they must be replaced. Otherwise the system might not work correctly.

10.4 - Motor shaft

The electronic control of the system ensures smooth starts so as to avoid excessive stress on the mechanical parts and thus prolong the life of the product. In exceptional cases this characteristic could cause problems in starting the pump: after a period of inactivity, perhaps with the system drained, the salts dissolved in the water could have settled and formed calcification between the moving part (motor shaft) and the fixed part of the pump, thus increasing the resistance on starting. In this case it may be sufficient to help the motor shaft by hand to detach itself from the calcifications. In this system the operation is possible because access to the motor shaft from outside is guaranteed and a groove is provided at the end of the shaft. Proceed as follows:

1. remove the motor shaft access cap as in Fig.27;
2. insert a straight tip screwdriver in the groove on the motor shaft and manoeuvre, turning in 2 directions;
3. if it turns freely, the system can be started;
4. if rotation is blocked it cannot be removed by hand, call the assistance service.

10.5 - Expansion Vessel

See paragraph 1.2 for the operations to check and adjust the air pressure in the expansion vessel and to replace it if it is broken.

11 - UPDATING THE E.SYBOX FIRMWARE

11.1 - General

This chapter describes how to update one or more e.sybox units when you have an e.sybox or an e.sylink with more recent firmware.

As already illustrated in the manual par. 9.4.2, to use the e.sybox in a pumping set with a wireless connection, the e.sybox firmware versions must all be the same.

If the e.sybox units in the group to be created have different firmware versions, it is necessary to make an update in order to align all the versions. The update may also be useful to have new firmware available which adds functions or solves problems.

Definitions used below:

Master: device from which a firmware is taken to load it in an e.sybox. The function may be fulfilled by an e.sybox, an e.sylink or any other device enabled for downloading firmware to an e.sybox.

Slave: e.sybox in the state of receiving a firmware update.



For updates performed with DConnect Box see the respective manual.

11.2 - Updating the firmware

The firmware can be updated by means of another e.sybox or by e.sylink. Depending on the firmware versions present and on the device available for programming (e.sybox or e.sylink) different procedures may be used.

During the firmware update the e.sybox and the e.sylink involved cannot carry out pumping functions. During the update the Slave e.sybox shows the message "LV LOADER v2.x" and a bar indicating the progress of the update. The update takes about 1 minute. At the end of this phase the e.sybox will restart.

Once the e.sybox has restarted it is advisable to check that the expected firmware has been installed. To do this, check the firmware version field "SW V." on "page VE" of the "User Menu". If any problems have occurred and the firmware has not been correctly installed, follow the indications for solving the problems of the various procedures described.

11.2.1 - Updating between one e.sybox and another

Updating between e.sybox units is possible only if one of them has a firmware version of 4.00 or more.

Updating can be carried out in 3 ways:

- **Manual:** the Master must have a firmware version of 4.00 or higher. It is not necessary to associate the e.sybox.
- **Automatic:** it is possible only if both the e.sybox units to be updated have a firmware version of 4.00 or higher. It is necessary to associate the e.sybox.

- **Semiautomatic:** the Master must have a firmware version of 4.00 or higher and the Slave must have a firmware version lower than 4.00. It is necessary to associate the e.sybox.

11.2.1.1 - Manual updating

Requirements

- It is carried out between 2 e.sybox units at a time.
- The Master must have a firmware version of 4.00 or higher.
- The e.sybox used as a Slave can have any firmware version.
- The firmware version of the Master must be greater or the same as the version of the Slave.
- Association between devices is not necessary.
- If several e.sybox units have to be updated the procedure must be repeated each time.

Procedure

1. Switch off the electric power supply to the e.sybox to be updated and wait for the display to switch off.
2. Go to page FW on the TECHNICAL ASSISTANCE menu of the e.sybox you want to use as the Master and press the key [+].
3. On the e.sybox to be updated, supply power by holding down simultaneously the [MODE] and [-] keys until the update screen appears.
4. Wait for the update to be successfully completed and for both machines to restart.

Problem solving

If the update has not been successful, repeat the procedure.

11.2.1.2 - Automatic updating

Requirements

- It is carried out between 2 e.sybox units at a time.
- The e.sybox used as the Master must have a firmware version of 4.00 or more.
- The e.sybox used as the Slave must have a firmware version of 4.00 or more.
- The firmware version of the Master must be greater or the same as the version of the Slave.
- It is necessary to have associated the devices with each other.

- If several e.sybox units have to be updated the procedure must be repeated each time.

Procedure

1. Associate the devices (see par. 7.5.5). A pop-up will appear on the display of both e.sybox units saying:

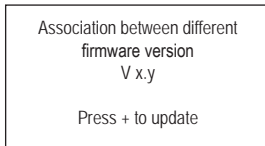

Where in place of x.y the firmware version of the e.sybox will appear.

2. Press the [+] key on both machines.
3. Wait for the update to be successfully completed and for both machines to restart.

Problem solving

If the update has not been successful, the machine that you were trying to update (Slave) goes into an inconsistent status which does not allow a new automatic update. In this case the updating procedure must be performed manually.

11.2.1.3 - Semiautomatic updating

Requirements

- It is carried out between 2 e.sybox units at a time.
- The e.sybox used as the Master must have a firmware version of 4.00 or more.
- The e.sybox used as the Slave must have a firmware version of less than 4.00.
- It is necessary to have associated the devices with each other.
- If several e.sybox units have to be updated the procedure must be repeated each time.

Procedure

1. Associate the devices.

The e.sybox with the older firmware (Slave) will show the screen:
The e.sybox with firmware version of 4.00 or more will show the screen:

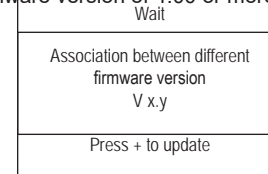

Where in place of x.y the firmware version of the e.sybox will appear.

2. Press the [+] key on the Master machine (the one with firmware version of 4.00 or more).
3. Switch off the electric power supply to the Slave e.sybox and wait for the display to switch off.
4. On the Slave e.sybox, supply power by holding down simultaneously the [MODE] and [-] keys until the update screen appears.
5. Wait for the update to be successfully completed and for both machines to restart.

Problem solving

If the update has not been successful, the machine that you were trying to update (Slave) goes into an inconsistent status which does not allow a new semiautomatic update. In this case the updating procedure must be performed manually.

11.2.2. - Updating the e.sybox by e.sylink

An e.sybox can also be updated by e.sylink. For the procedure, refer to the e.sylink manual.

12 - TROUBLESHOOTING



Before starting to look for faults it is necessary to disconnect the power supply to the pump (take the plug out of the socket).

Solving typical problems

Fault	LED	Probable Causes	Remedies
The pump does not start.	Red: off White: off Blue: off	No electric power.	Check whether there is voltage in the socket and insert the plug again.
The pump does not start.	Red: on White: on Blue: off	Shaft blocked.	See paragraph 10.4 (motor shaft maintenance).
The pump does not start.	Red: off White: on Blue: off	Utility at a level higher than the system restarting pressure level (par. 3.2).	Increase the system restarting pressure level by increasing SP or decreasing RP.
The pump does not stop.	Red: off White: on Blue: off	<ol style="list-style-type: none"> 1. Leak in the system. 2. Impeller or hydraulic part clogged. 3. Air getting into the suction pipe. 4. Faulty flow sensor 	<ol style="list-style-type: none"> 1. Check the system, find and eliminate the leak. 2. Dismantle the system and remove the obstructions (assistance service). 3. Check the suction pipe, find and eliminate the cause of air getting in. 4. Contact the assistance centre.

Insufficient delivery	Red: off White: on Blue: off	<ol style="list-style-type: none"> 1. Suction depth too high. 2. Suction pipe clogged or diameter insufficient. 3. Impeller or hydraulic part clogged. 	<ol style="list-style-type: none"> 1. As the suction depth increases the hydraulic performance of the product decreases (<i>Description of the Electropump</i>). Check whether the suction depth can be reduced. Use a suction pipe with a larger diameter (but never smaller than 1"). 2. Check the suction pipe, find the cause of choking (obstruction, dry bend, counterslope, ...) and remove it. 3. Dismantle the system and remove the obstructions (assistance service).
The pump starts without utility request.	Red: off White: on Blue: off	<ol style="list-style-type: none"> 1. Leak in the system. 2. Faulty non-return valve. 	<ol style="list-style-type: none"> 1. Check the system, find and eliminate the leak. 2. Service the non-return valve as described in par. 10.3.
The water pressure when turning on the utility is not immediate.	Red: off White: on Blue: off	Expansion vessel empty (insufficient air pressure) or has broken diaphragm.	Check the air pressure through the valve in the technical compartment. If water comes out when checking, the vessel is broken: assistance service. Otherwise restore the air pressure according to the equation par. 1.2.
When the utility is turned on the flow falls to zero before the pump starts	Red: off White: on Blue: off	Air pressure in the expansion vessel higher than the system starting pressure.	TCalibrate the expansion vessel pressure or configure the parameters SP and/or RP so as to satisfy the equation par.1.2.

The display shows BL	Red: on White: on Blue: off	<ol style="list-style-type: none"> 1. No water. 2. Pump not primed. 3. Setpoint not reachable with the set RM value 	<ol style="list-style-type: none"> 1-2. Prime the pump and check whether there is air in the pipe. Check whether the suction or any filters are blocked. 3. Set a RM value that allows the setpoint to be reached.
The display shows BP1	Red: on White: on Blue: off	<ol style="list-style-type: none"> 1. Faulty pressure sensor. 	<ol style="list-style-type: none"> 1. Contact the assistance centre.
The display shows OC	Red: on White: on Blue: off	<ol style="list-style-type: none"> 1. Excessive absorption. 2. Pump blocked. 	<ol style="list-style-type: none"> 1. Fluid too dense. Do not use the pump for fluids other than water. 2. Contact the assistance centre.
The display shows PB	Red: on White: on Blue: off	<ol style="list-style-type: none"> 1. Supply voltage too low. 2. Excessive drop in voltage on the line. 	<ol style="list-style-type: none"> 1. Check the presence of the correct supply voltage. 2. Check the section of the power supply cables.
The display shows: Press + to propagate this config	Red: off White: on Blue: off	One or more devices have sensitive parameters not aligned.	Press the + key on the device which we are sure has the most recent and correct configuration of the parameters.

13 - DISPOSAL

This product or its parts must be disposed of in an environment-friendly manner and in compliance with the local regulations concerning the environment; use public or private local waste collection systems.

14 - GUARANTEE

Any use of faulty material or manufacturing defects of the appliance will be eliminated during the guarantee period contemplated by the law in force in the country where the product is purchased, by repair or replacement, as we decide.

The guarantee covers all substantial defects that can be assigned to manufacturing faults or to the material used if the product has been used correctly, in accordance with the instructions.

The guarantee is void in the following cases:

- attempts to repair the appliance,
- technical alterations to the appliance,
- use of non original spare parts,
- tampering.
- inappropriate use, for example industrial use.

Excluded from the guarantee:

- parts subject to rapid wear.

When making a request under guarantee, apply to an authorised technical assistance service, presenting proof of purchase of the product.