

# CPE / CP-GE / DCPE / DCP-GE

## ELECTRONIC IN-LINE PUMPS FOR CIRCULATION SYSTEMS



### TECHNICAL DATA

**Operating range:**

from 1,2 to 230 m<sup>3</sup>/h with head up to 56 metres

**Pumped liquid:** clean, free of solids and abrasives, non-viscous, non-aggressive, non-crystallised and chemically neutral, with properties similar to water.

**Maximum operating pressure:**

PN10 : DN 40 - DN 50

PN16 : Remainder of the range

**Flanging:** PN 16.

**Counter flanges on request:**

DN 40 - DN 50 - DN 65 - DN 80 - DN 100 - DN 125 - DN 150; PN 16.

**Protection:** IP 55

**Insulation:** class F

**Liquid temperature range:**

-10 °C to +130 °C for DN 40 - 50

-10 °C to +140 °C for the remainder of the range

**Maximum ambient temperature:** +40°C

**Maximum working pressure:** 16 bar

**Standard single-phase voltage:** 1x220-240 V / 50-60 Hz

**Special version on request:**

three-phase 3x400 V / 50 Hz or three-phase 3x460 V / 60 Hz

**Standard three-phase voltage:** 3x400 V / 50 Hz

**Special version on request:** 3x460 V / 60 Hz

**Pumped liquid:** clean, free of solids and abrasives, non-viscous, non-aggressive, non-crystallised and chemically neutral.

### APPLICATIONS

In-line port circulation pumps, suitable for heating, air conditioning, refrigeration and sanitary water systems. Particularly versatile thanks to the use of the MCE/C inverter, offering performance features capable of automatically adapting to the different needs of the system, keeping a consistent differential pressure. Available in the single and twin versions.

### CONSTRUCTION FEATURES OF THE PUMP

PN 16 flanged suction and delivery ports with threaded holes for control manometers. Cast iron pump body and motor support, cast iron or technopolymer impeller depending on mode (bronze impeller available on request for DN 65 to DN 150 models only). Stainless steel motor shaft. Seal device: standardised mechanical seal according to DIN 24960 in carbon/silicon carbide with EPDM OR rings.

### CONSTRUCTION FEATURES OF THE MOTOR

External ventilation asynchronous type motor. Rotor running on ball bearings, oversized to ensure low noise and durability. Construction according to CEI 2-3.

### CONSTRUCTION FEATURES OF THE ELECTRONICS: MCE/C INVERTER

MCE/C inverters are the latest technological achievement of the DAB inverter range. They represent a new generation of inverters for use with circulation pumps, and set themselves apart due to ease of use, power, simplicity of installation and management. MCE/C inverters have been designed for managing circulation pumps. By allowing a simple adjustment of the differential pressure, they give the possibility of adjusting the performance of the circulation pump to the actual system requirements. They are fitted on the fan cover of the motor. This makes the installation of the pump with MCE/C particularly easy and quick. The protection class of the MCE/C is IP55. The easy of programming is guaranteed by the use of a simple and intuitive interface, similar to Dialogue electronic circulators, and a graphic display. MCE/C inverters have a double micro-processor construction that guarantees maximum efficiency and reliability.

A reliable and sturdy construction, together with a modern and innovative design, complete the product, also in terms of aesthetic value. MCE/C inverters protect the motor and the pump, and increase their life, by eliminating hammering effects and making the pump rotate at the minimum number of rotations capable of meeting the requirements of the user. In addition, electric pumps controlled by the MCE/C inverter are environmentally friendly. In fact, by ensuring that the pump only uses the power that is strictly necessary for meeting the needs of the users, electricity consumption is strongly reduced when compared with fixed speed pumps. It is possible to create twin units by using the appropriate cable for the connection of MCE/C inverters.

# CPE / CP-GE / DCPE / DCP-GE

ELECTRONIC IN-LINE PUMPS FOR CIRCULATION SYSTEMS

## MATERIALS

N.	PARTS	MATERIALS
1	PUMP BODY	CAST IRON 250 UNI ISO 185
3	SUPPORT	CAST IRON 250 UNI ISO 185
4	IMPELLER	CAST IRON DN 65-80-100 / DCPE DN 40 - 50 / CPE 40-4700T, CPE 40-5500T, CPE 40-6200T, CPE 50-4600T, CPE 50-5650T
		TECHNOPOLYMER B CPE 40-2300T, CPE 40-3500T, CPE 50-2600T, CPE 50-4100T
7	SHAFT WITH ROTOR	AISI 303 STAINLESS STEEL X10 CrNiS 1809 UNI 6900/71
16	MECHANICAL SEAL	CARBON/GRAPHITE
28	OR RING	EPDM RUBBER

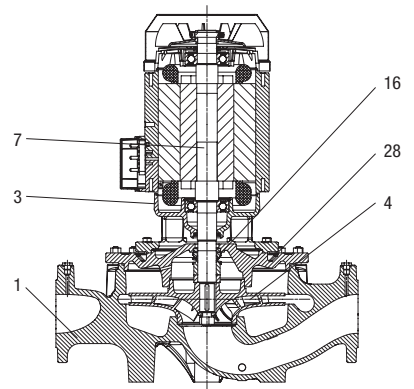

\* In contact with the liquid

### - Legend: (example)

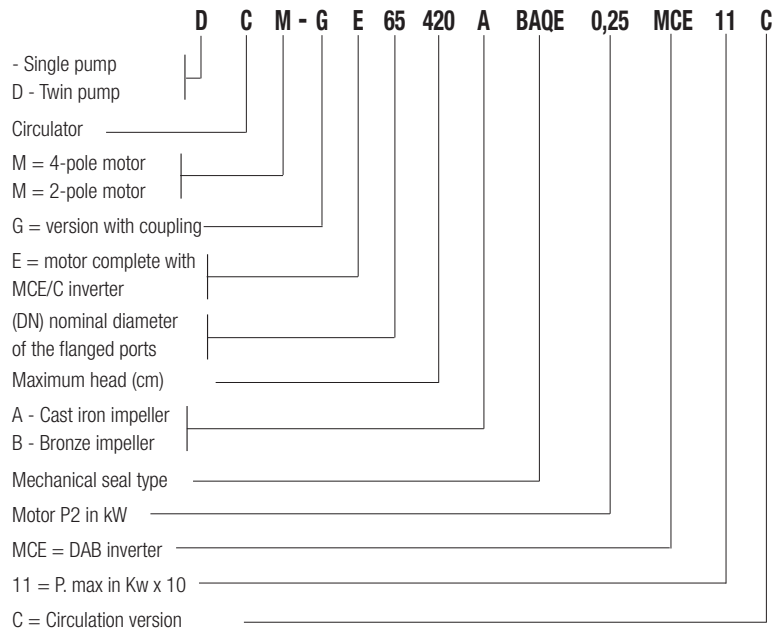

**Installation: horizontal or vertical position, provided that the motor is always above the pump.**

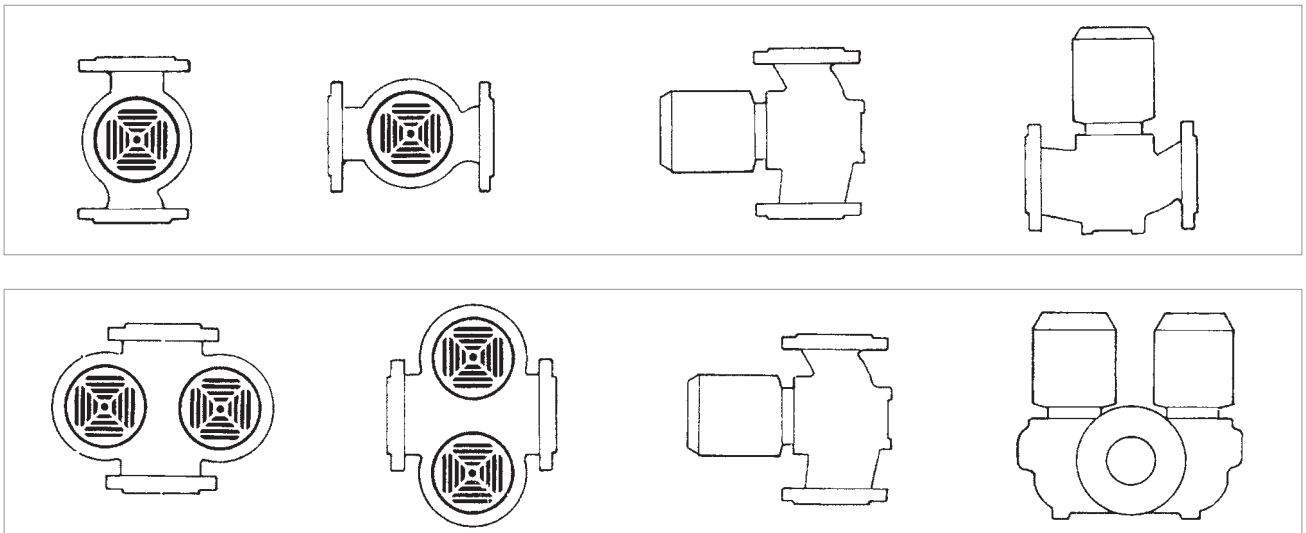

### MCE/C INVERTER

#### MODES OF OPERATION

All the functions listed below can be consulted by the users (including less experienced ones) by simply scrolling through the MCE/C menu. The calibration and the modification of the parameters are protected, and can only be completed by expert users.

#### 1 - $\Delta P$ -c constant differential pressure adjustment mode

The  $\Delta P$ -c adjustment mode keeps the differential pressure of the system constantly at the H (setp) value set, even in case of variation of the flow rate. This is the standard adjustment used. It can be set directly from the MCE/C control panel. The inverter keeps the differential pressure (H setp) constant even in case of flow variation.

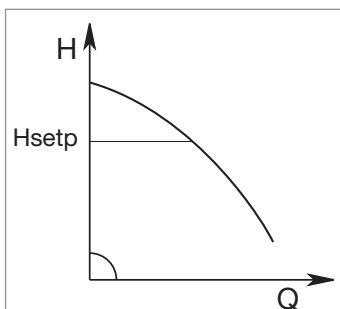

This adjustment is particularly indicated for the following systems:

- a. two-pipe heating systems with thermostat valves**
- b. underfloor heating systems with thermostat valves**
- c. single-pipe heating systems with thermostat valves and calibration valves**
- d. systems with primary circuit pumps**

#### 2 - Constant curve adjustment modes

##### 2.1 - Constant curve adjustment

The rotation speed is kept at a constant number of revolutions. This rotation speed can be set between a minimum value and the nominal frequency of the circulation pump (e.g. between 15 Hz and 50 Hz). This mode can be set using the control panel on the MCE cover.

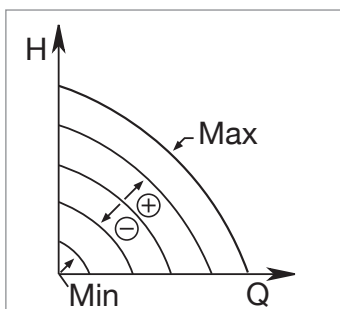

##### 2.2 - Adjustment of the constant curve with external analogue signal

The rotation speed is kept at a constant number of revolution in proportion with the voltage of the external analogue signal.

The rotation speed changes in a linear way, between the nominal frequency of the pump when  $V_{in} = 10$  V, and the minimum frequency when  $V_{in} = 0$  V.

This mode can be set using the control panel on the MCE cover.

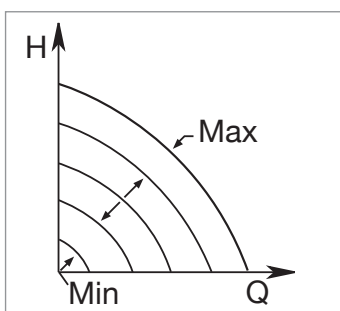

#### 3 - $\Delta P$ -v \* proportional differential pressure adjustment mode

With  $\Delta P$ -v adjustment mode, with the variation of the flow rate, the value of the delivery of the head also varies in a linear manner, from Hsetp to Hsetp/2.

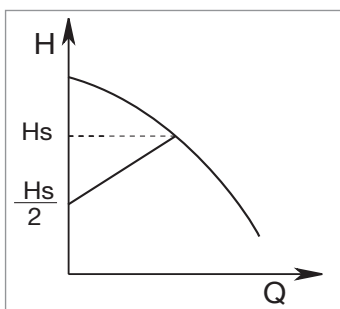

For more information refer to the technical appendix.

# ELECTRIC IN-LINE PUMPS

## ELECTRONIC IN-LINE PUMPS FOR CIRCULATION SYSTEMS

### PERFORMANCE RANGE

The performance curves are based on kinematic viscosity values = 1 mm<sup>2</sup>/s and density equal to 1000 kg/m<sup>3</sup>. Curve tolerance according to ISO 9906.

### GRAPHIC SELECTION TABLE

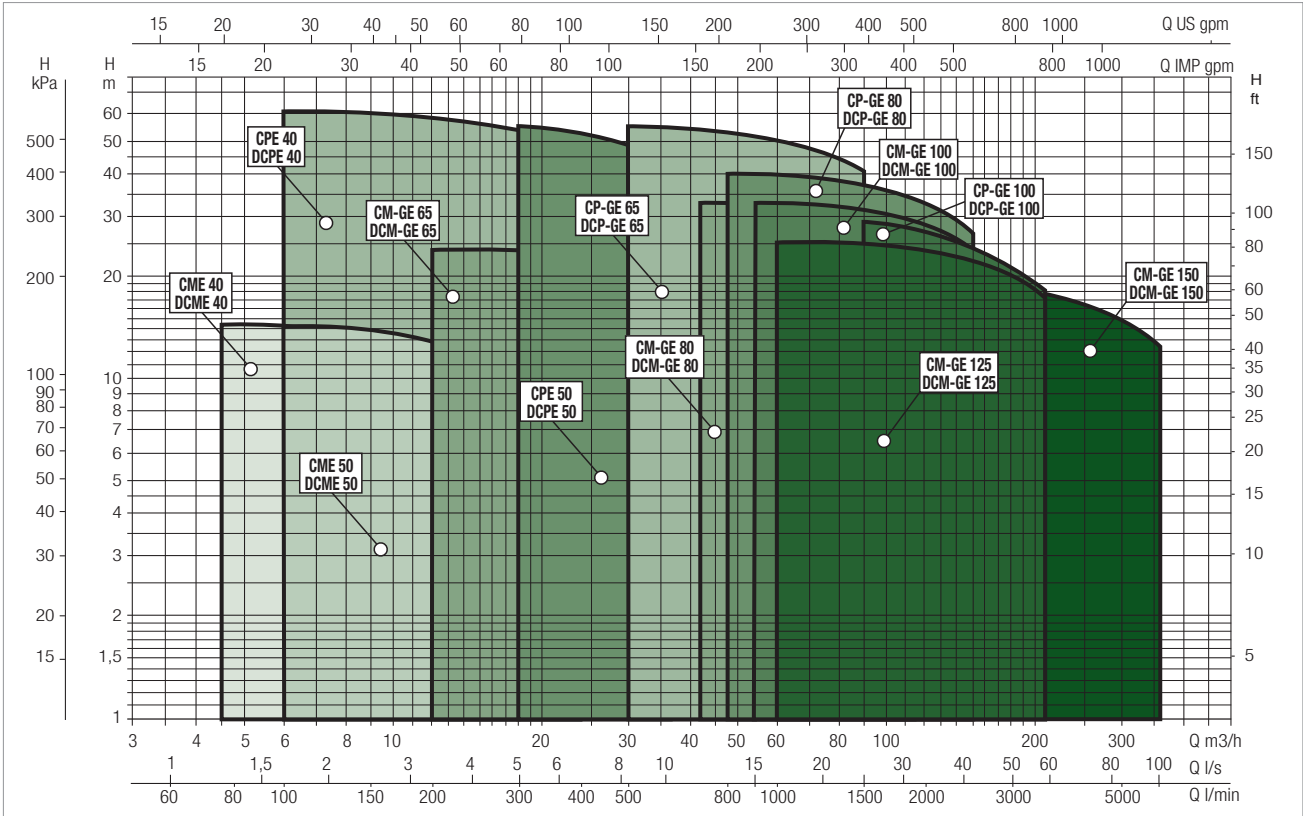

### SELECTION TABLE - CPE - 2 POLES

MODEL	Q=																			
	m <sup>3</sup> /h	0	3,6	4,8	6	12	18	24	30	36	42	48	54	60	66	72	78	84	90	
	Q=	0	60	80	100	200	300	400	500	600	700	800	900	1000	1100	1200	1300	1400	1500	
	l/min																			
CPE 40/2300 M MCE11/C IE2	H (m)	21,8	21,8	21,3	21	18														
CPE 40/2300 T MCE30/C IE2		21,8	21,8	21,3	21	18														
CPE 40/3500 M MCE22/C IE2		34,8	34,9	34,7	34,2	31,7														
CPE 40/3500 T MCE30/C IE2		34,8	34,9	34,7	34,2	31,7														
CPE 40/4700 T MCE55/C IE2					47	44	39,5	35												
CPE 40/5500 T MCE55/C IE2					55	53	48	42												
CPE 40/6200 T MCE110/C IE2					62	59	54	49												
CPE 50/2600 M MCE15/C IE2					25	22	16													
CPE 50/2600 T MCE 30/C IE2					25	22	16													
CPE 50/4100 T MCE30/C IE2					40,7	38,5	34,5	27,7												
CPE 50/4600 T MCE55/C IE2							44	41,5	37	31										
CPE 50/5650 T MCE110/C IE2							55,5	53	49	44										



# CPE / CP-GE / DCPE / DCP-GE

ELECTRONIC IN-LINE PUMPS FOR CIRCULATION SYSTEMS

## SELECTION TABLE - CPE - 2 POLES

MODEL	Q=	0	6	12	18	24	30	36	42	48	54	60	66	72	78	84	90	102	114	120	150	180	210	
	m <sup>3</sup> /h	0	100	200	300	400	500	600	700	800	900	1000	1100	1200	1300	1400	1500	1700	1900	2000	2500	3000	3500	
CP-GE 65-1470/A/BAQE/1.5 M MCE11/C IE2	H (m)	14,7	14,5	14,3	13,8	13	11,8	10,5	8,6	7														
CP-GE 65-1470/A/BAQE/1.5 T MCE30/C IE2		14,7	14,5	14,3	13,8	13	11,8	10,5	8,6	7														
CP-GE 65-2280/A/BAQE/3 T MCE30/C IE2		22,8	22,5	22,3	22	21,2	20,2	19	17,4	15,5	13,5													
CP-GE 65-2640/A/BAQE/4 T MCE55/C IE2		26,4	26,2	26	25,6	25	24	23	21,5	19,5	17,5	15												
CP-GE 65-3400/A/BAQE/5.5 T MCE55/C IE2		34			34	33,5	32,5	31	29,5	27	24													
CP-GE 65-4100/A/BAQE/7.5 T MCE110/C IE2		41			41	41	40	39	37,5	35,5	33	30	26,5											
CP-GE 65-4700/A/BAQE/11 T MCE110/C IE2		47					45,5	45	44,3	43,3	42	40,8	39	37	35	32,3								
CP-GE 65-5500/A/BAQE/15 T MCE150/C IE2		55						56	55,5	54	53,5	52	51	49	47,5	45,5	43	41						
CP-GE 80-1400/A/BAQE/2.2 M MCE22/C IE2		14				13,8	13,3	12,9	12,5	12,1	11,4	10,8	10	9,2	8,3	7,5								
CP-GE 80-1400/A/BAQE/2.2 T MCE30/C IE2		14				13,8	13,3	12,9	12,5	12,1	11,4	10,8	10	9,2	8,3	7,5								
CP-GE 80-2050/A/BAQE/4 T MCE55/C IE2		20,5				20	19,5	19,1	18,5	18	17,5	16,5	15,8	14,8	14	12,5	11,5							
CP-GE 80-2400/A/BAQE/5.5 T MCE55/C IE2		24				23,6	23,5	23,2	22,8	22,2	21,5	21	20	19,1	18,5	17,5	16,5	13,4						
CP-GE 80-2770/A/BAQE/7.5 T MCE110/C IE2		27,7								27,5	27,3	27,1	26,7	25,8	25,6	24,9	24,5	23	21,2	20,1				
CP-GE 80-3250/A/BAQE/11 T MCE110/C IE2		32,5								32,2	32	31,8	31,3	30,2	30	29,2	28,7	27	24,8	23,6				
CP-GE 80-4000/A/BAQE/15 T MCE150/C IE2		40								40,2	40	39,8	39,5	39	38,5	38,2	37,5	36	34,5	33,5	26,9			
CP-GE 100-1600/A/BAQE/4 T MCE55/C IE2		16						15	14,6	14,2	13,7	13,3	12,8	12,3	11,7	11	10,4	9,3	8					
CP-GE 100-1950/A/BAQE/5.5 T MCE55/C IE2		19,5						19	18,9	18,7	18,4	18,1	17,5	17,2	16,9	16,5	15,8	14,5	13	12				
CP-GE 100-2350/A/BAQE/7.5 T MCE110/C IE2		23,5						23,1	23	22,8	22,6	22,5	22	21,6	21,1	20,7	20,2	19	17,5	14,8	12			
CP-GE 100-2400/A/BAQE/11 T MCE110/C IE2		24															22	21,4	20,4	20	17,4	16,8	12	
CP-GE 100-3050/A/BAQE/15 T MCE150/C IE2		30,5																29	28,4	27,5	27	24,5	21,3	18,3

# CPE / CP-GE / DCPE / DCP-GE

## ELECTRONIC IN-LINE PUMPS FOR CIRCULATION SYSTEMS

### SELECTION TABLE - DCPE - 2 POLES

MODEL	Q=	6	7,5	9	10,5	12	13,5	15	18	21	24	27	30	36	42	48	54	60	180	210		
	m <sup>3</sup> /h Q= l/min	100	125	150	175	200	225	250	300	350	400	450	500	600	700	800	900	1000	3000	3500		
DCPE 40/1650 M MCE11/C IE2	H (m)	16,5	15,5	14,5	13,5	12,3	11	9,5	6													
DCPE 40/2450 M MCE15/C IE2		24,5	24	23,5	23	22	21	20	16,5	13												
DCPE 40/2450 T MCE30/C IE2		24,5	24	23,5	23	22	21	20	16,5	13												
DCPE 50/1550 M MCE15/C IE2								15,5	15	14,1	13	11,8	10,5	7								
DCPE 50/1550 T MCE30/C IE2								15,5	15	14,1	13	11,8	10,5	7								
DCPE 50/2450 T MCE30/C IE2								24,5	24	23,5	23	22	20,5	17								
DCPE 50/3650 T MCE55/C IE2								36,5	35,5	34,5	33,5	32,5	31	27								

### SELECTION TABLE - DCP-GE - 2 POLES

MODEL	Q=	0	6	12	18	24	30	36	42	48	54	60	66	72	78	84	90	102	114	120	150	180	210	
	m <sup>3</sup> /h Q= l/min	0	100	200	300	400	500	600	700	800	900	1000	1100	1200	1300	1400	1500	1700	1900	2000	2500	3000	3500	
DCP-GE 65-1470/A/BAQE/1.5M MCE11/C	H (m)	14,4	14,2	13,8	13,1	12,0	10,6	9,0	7,0	5,3														
DCP-GE 65-1470/A/BAQE/1.5 T MCE30/C		14,4	14,2	13,8	13,1	12,0	10,6	9,0	7,0	5,3														
DCP-GE 65-2280/A/BAQE/3 T MCE30/C		22,3			21,1	19,9	18,4	16,8	14,7	12,5	10,2													
DCP-GE 65-2640/A/BAQE/4 T MCE55/C		25,9			24,6	23,7	22,2	20,7	18,8	16,4	14,0	11,4												
DCP-GE 65-3400/A/BAQE/5.5 T MCE55/C		33,3			32,5	31,4	29,7	27,4	25,0	21,7	18,2													
DCP-GE 65-4100/A/BAQE/7.5 T MCE110/C		40,2			39,6	39,0	37,4	35,7	33,4	30,7	27,5	23,9	20,1											
DCP-GE 65-4700/A/BAQE/11 T MCE110/C		46,4				44,3	43,6	42,6	41,3	39,6	38,1	35,9	33,6	31,3										
DCP-GE 65-5500/A/BAQE/15 T MCE150/C		54,3				54,7	53,9	52,1	51,2	49,4	48,0	45,6	43,7	41,3	38,4	36,1								
DCP-GE 80-1400/A/BAQE/2.2 M MCE30/C		13,7				14,3	13,7	13,0	12,3	11,4	10,3	9,1	7,8	6,5	5,2	4,0								
DCP-GE 80-1400/A/BAQE/2.2 T MCE30/C		13,7				14,3	13,7	13,0	12,3	11,4	10,3	9,1	7,8	6,5	5,2	4,0								
DCP-GE 80-2050/A/BAQE/4T MCE55/C		20,1				20,8	20,1	19,5	18,4	17,4	16,2	14,6	13,1	11,3	9,7	7,7	6,1							
DCP-GE 80-2400/A/BAQE/5.5 T MCE55/C		23,5				24,5	24,4	23,9	23,1	22,1	20,8	19,6	17,9	16,3	14,8	13,0	11,2	7,1						
DCP-GE 80-2770/A/BAQE/7.5 T MCE110/C		27,1								26,6	26,0	25,3	24,3	22,8	21,9	20,5	19,3	16,2	13,0	11,3				
DCP-GE 80-3250/A/BAQE/11 T MCE110/C		31,9								31,2	30,5	29,7	28,5	26,7	25,6	24,0	22,6	19,1	15,2	13,2				
DCP-GE 80-4000/A/BAQE/15 T MCE150/C		39,2								39,7	39,1	38,5	37,7	36,7	35,6	34,6	33,2	30,1	26,9	25,1	15,1			
DCP-GE 100-1600/A/BAQE/4 T MCE55/C		16,0						15,8	15,2	14,5	13,6	12,8	11,8	10,8	9,6	8,4	7,3	5,1	3,0					
DCP-GE 100-1950/A/BAQE/5.5 T MCE55/C		19,5						20,1	19,8	19,2	18,5	17,7	16,5	15,5	14,5	13,3	11,8	9,0	6,0	4,5				
DCP-GE 100-2350/A/BAQE/7.5 T MCE110/C		23,5						24,5	24,4	24,0	23,6	23,1	22,2	21,4	20,4	19,4	18,3	15,7	12,9	11,7	4,5			
DCP-GE 100-2400/A/BAQE/11 T MCE110/C		23,6															21,9	21,0	19,7	19,1	15,5	13,4	8,2	
DCP-GE 100-3050/A/BAQE/15 T MCE150/C		30,0															28,9	27,9	26,5	25,8	21,8	17,0	12,5	

# DCPE 40 2 POLES - ELECTRONIC IN-LINE PUMPS FOR HEATING, AIR CONDITIONING, REFRIGERATION, SOLAR, AND SANITARY SYSTEMS - TWIN, FLANGED, WITH MCE/C INVERTER

Pumped liquid temperature range: from -10 °C to +130°C - Maximum ambient temperature: +40°C

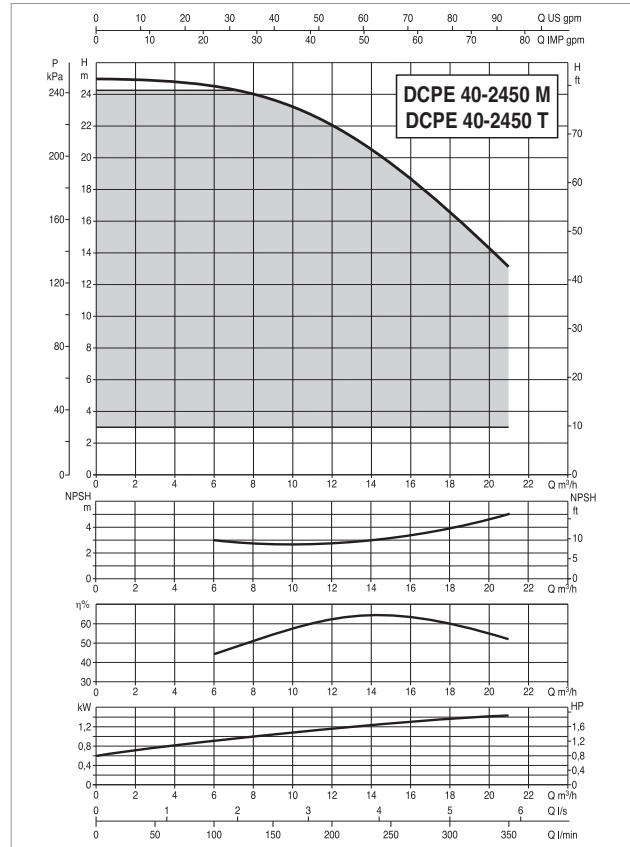
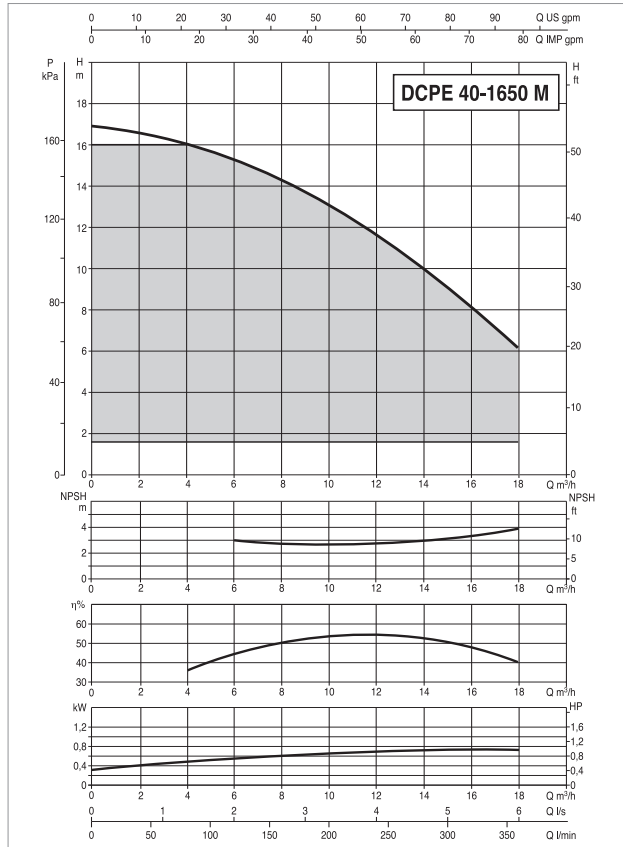

For the MEI index refer to the hydraulic data of the individual pump.

The performance curves are based on kinematic viscosity values = 1 mm²/s and density equal to 1000 kg/m³. Curve tolerance according to ISO 9906.

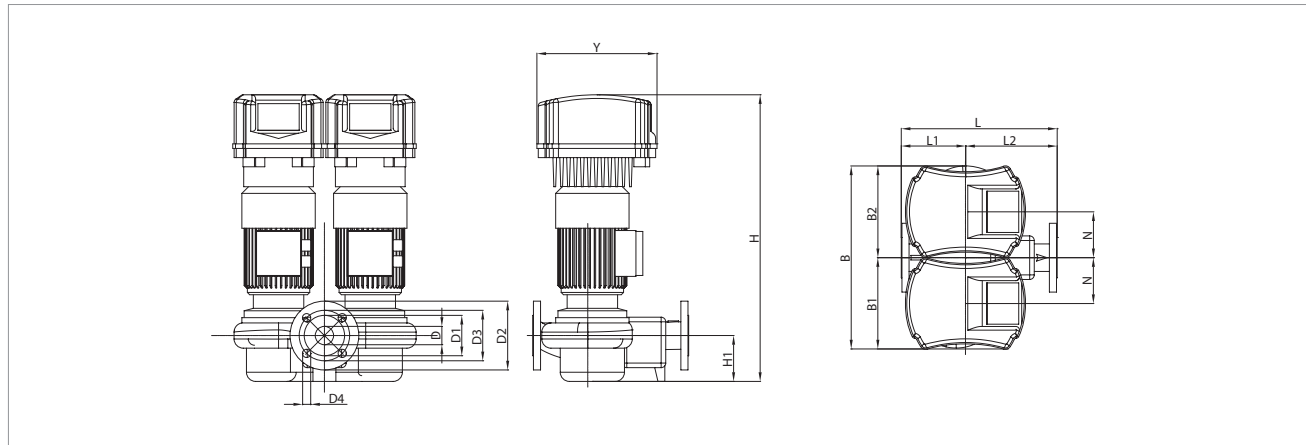

MODEL	ELECTRICAL DATA						
	POWER INPUT 50-60 Hz	MOTOR TYPE	n r.p.m.	P1 MAX W	P2 NOMINAL		In A
					kW	HP	
DCPE 40/1650 M MCE11/C IE2	1 x 220-240 V ~	2 poles	2900	1,10	0,75	1,0	9,0
DCPE 40/2450 M MCE15/C IE2	1 x 220-240 V ~	2 poles	2900	2,17	1,5	2,0	15,8
DCPE 40/2450 T MCE30/C IE2	3 x 400 V ~	2 poles	2900	2,17	1,5	2,0	t.b.d.

MODEL	L	L1	L2	B	B1	B2	H	H1	N	D	D1	D2	D3	D4	Y	PACKING DIMENSIONS			VOLUME (m³)	WEIGHT kg
																L/A	L/B	H		
DCPE 40/1650 M MCE11/C IE2	340	130	210	400	200	200	625	100	100	40 PN16	88	150	110	262	262	520	400	710	0,15	54
DCPE 40/2450 M MCE15/C IE2	340	130	210	400	200	200	625	100	100	40 PN16	88	150	110	262	262	520	400	710	0,15	58
DCPE 40/2450 T MCE30/C IE2	340	130	210	400	200	200	625	100	100	40 PN16	88	150	110	262	262	520	400	710	0,15	58

# DCPE 50 2 POLES - ELECTRONIC IN-LINE PUMPS FOR HEATING, AIR CONDITIONING, REFRIGERATION, SOLAR, AND SANITARY SYSTEMS - TWIN, FLANGED, WITH MCE/C INVERTER

Pumped liquid temperature range: from -10 °C to +130°C - Maximum ambient temperature: +40°C

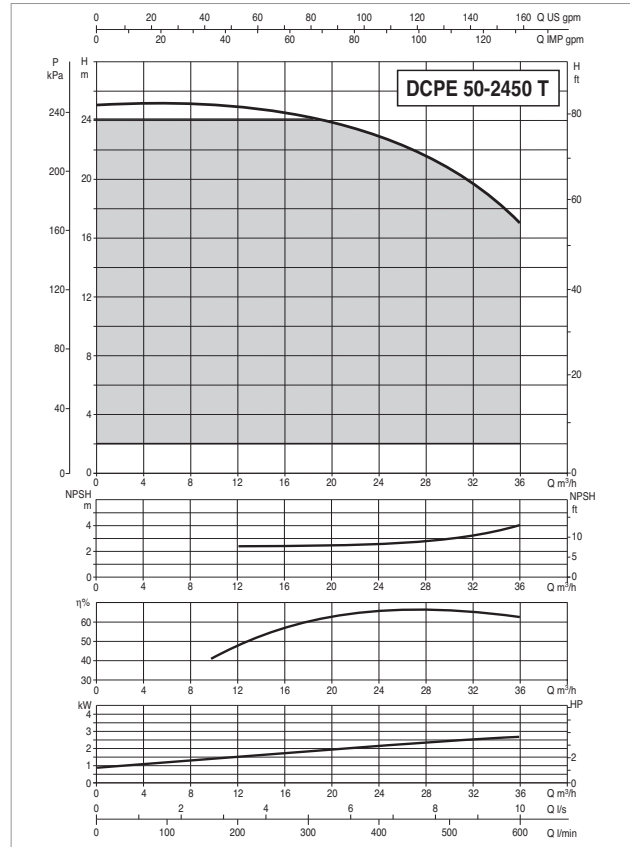
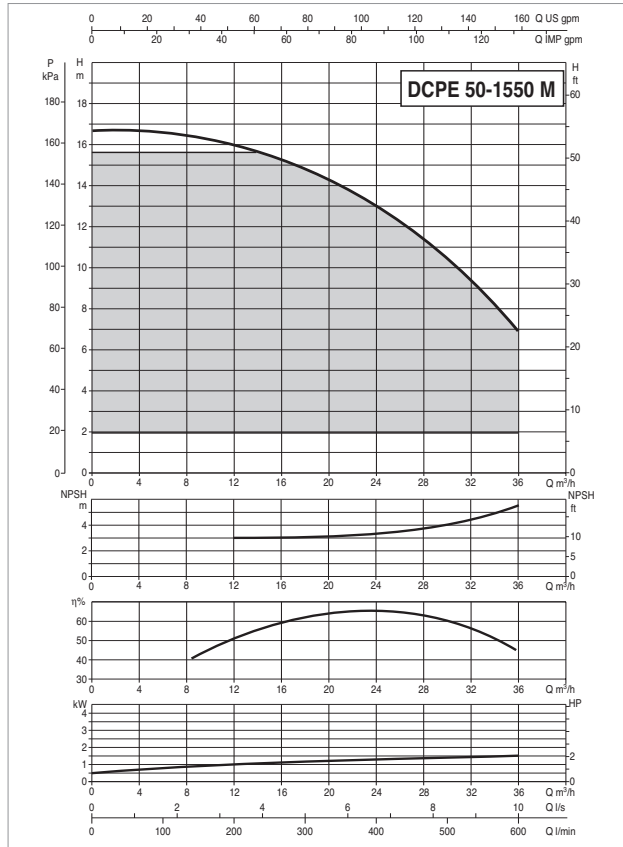

For the MEI index refer to the hydraulic data of the individual pump.

The performance curves are based on kinematic viscosity values = 1 mm<sup>2</sup>/s and density equal to 1000 kg/m<sup>3</sup>. Curve tolerance according to ISO 9906.

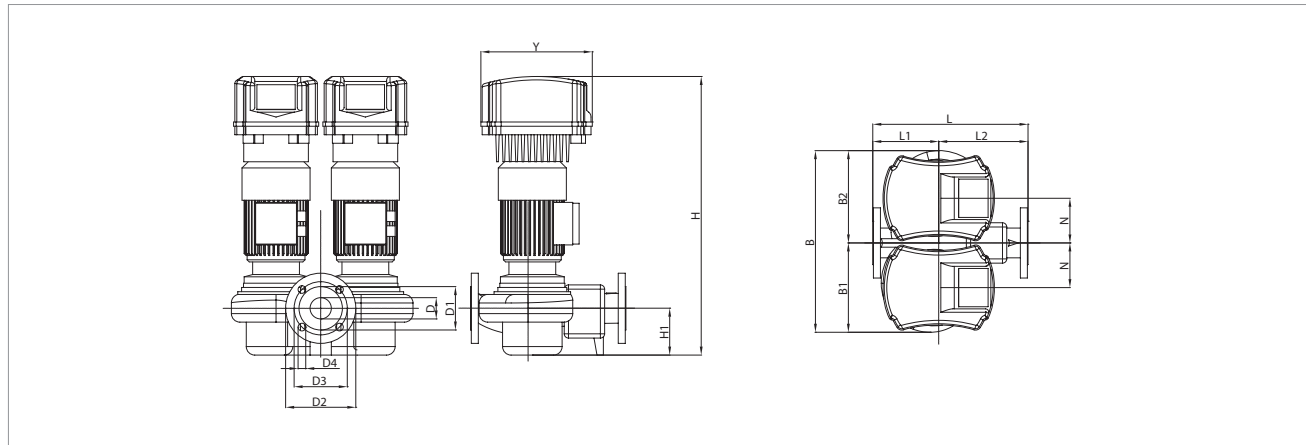

MODEL	ELECTRICAL DATA						
	POWER INPUT 50-60 Hz	MOTOR TYPE	n r.p.m.	P1 MAX W	P2 NOMINAL		In A
					kW	HP	
DCPE 50/1550 M MCE15/C IE2	1 x 220-240 V ~	2 poles	2900	2,17	1,5	2,0	15,8
DCPE 50/1550 T MCE30/C IE2	3 x 400 V ~	2 poles	2900	2,17	1,5	2,0	t.b.d.
DCPE 50/2450 T MCE30/C IE2 *	3 x 400 V ~	2 poles	2900	3,72	3,0	4,0	6,8

\* ΔP-v proportional differential pressure adjustment mode also available.

MODEL	L	L1	L2	B	B1	B2	H	H1	N	D	D1	D2	D3	D4	Y	PACKING DIMENSIONS			VOLUME (m <sup>3</sup> )	WEIGHT kg
																L/A	L/B	H		
DCPE 50/1550 M MCE15/C IE2	365	145	220	427	217	210	655	110	105	50 PN16	102	165	125	4 HOLES Ø18	262	520	400	710	0,15	60
DCPE 50/1550 T MCE30/C IE2	365	145	220	427	217	210	655	110	105	50 PN16	102	165	125		262	520	400	710	0,15	60
DCPE 50/2450 T MCE30/C IE2	365	145	220	427	217	210	655	110	105	50 PN16	102	165	125		353	520	400	710	0,15	75

# DCPE 50 2 POLES - ELECTRONIC IN-LINE PUMPS FOR HEATING, AIR CONDITIONING, REFRIGERATION, SOLAR, AND SANITARY SYSTEMS - TWIN, FLANGED, WITH MCE/C INVERTER

Pumped liquid temperature range: from -10 °C to +130°C - Maximum ambient temperature: +40°C

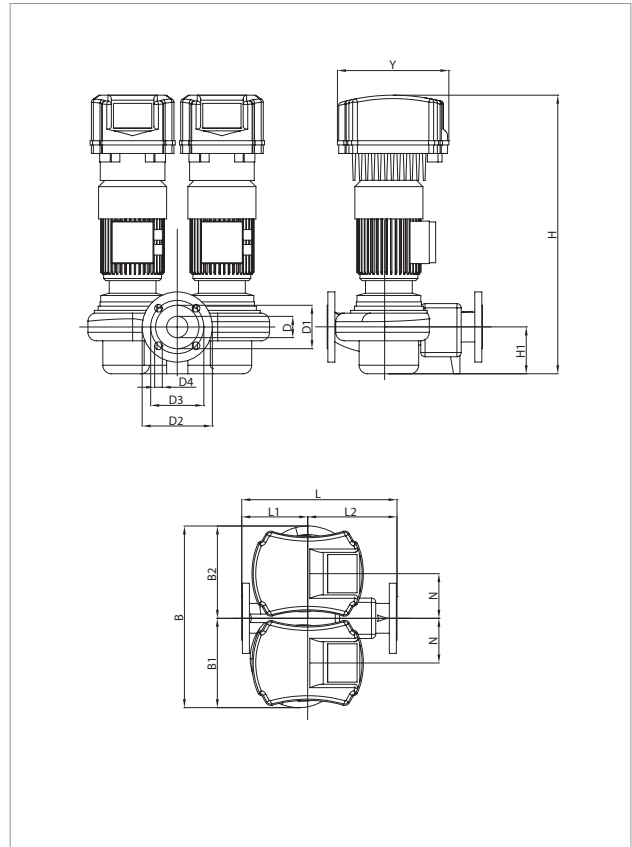
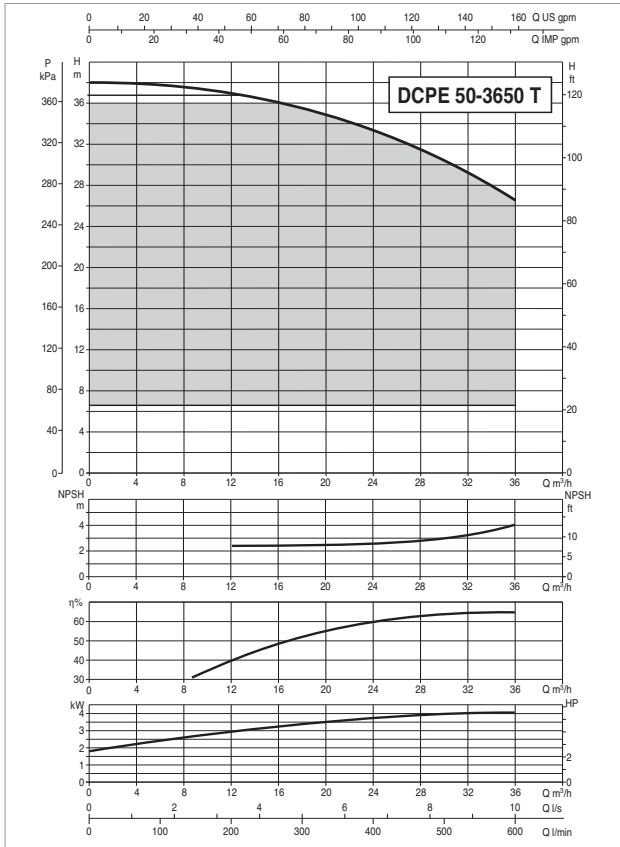

For the MEI index refer to the hydraulic data of the individual pump.

The performance curves are based on kinematic viscosity values = 1 mm<sup>2</sup>/s and density equal to 1000 kg/m<sup>3</sup>. Curve tolerance according to ISO 9906.

MODEL	ELECTRICAL DATA						
	POWER INPUT 50-60 Hz	MOTOR TYPE	n r.p.m.	P1 MAX W	P2 NOMINAL		In A
					kW	HP	
DCPE 50/3650 T MCE55/C IE2	3 x 400 V ~	2 poles	2900	5,11	4,0	5,5	9,6

MODEL	L	L1	L2	B	B1	B2	H	H1	N	D	D1	D2	D3	D4	Y	PACKING DIMENSIONS			VOLUME (m <sup>3</sup> )	WEIGHT kg
																L/A	L/B	H		
DCPE 50/3650 T MCE55/C IE2	410	170	240	480	235	245	735	110	120	50 PN16	102	165	125	4 HOLES Ø18	353	700	600	970	0,41	95

# DCP-GE 65 2 POLES - ELECTRONIC IN-LINE PUMPS FOR HEATING, AIR CONDITIONING, REFRIGERATION, SOLAR, AND SANITARY SYSTEMS - TWIN, FLANGED, WITH MCE/C INVERTER

Pumped liquid temperature range: from -10 °C to +140°C - Maximum ambient temperature: +40°C

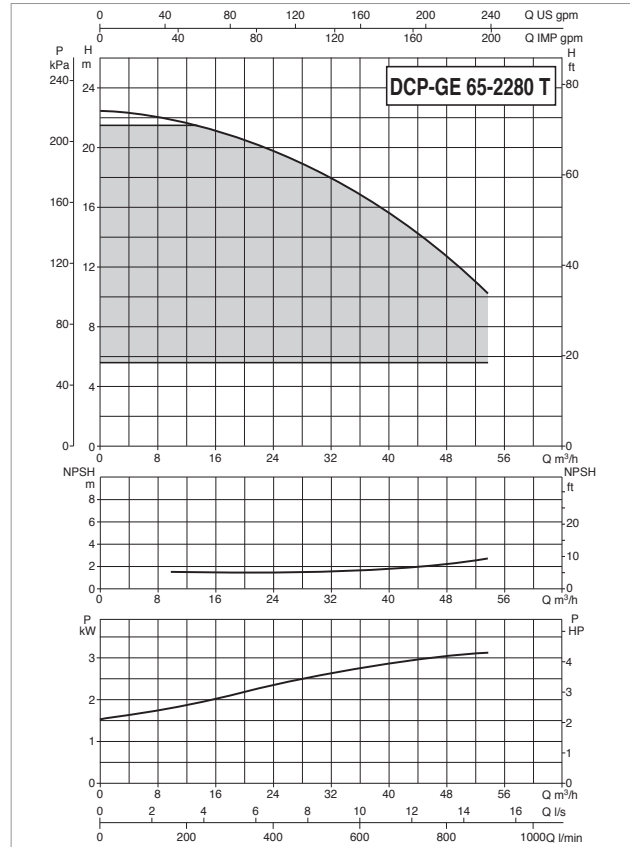
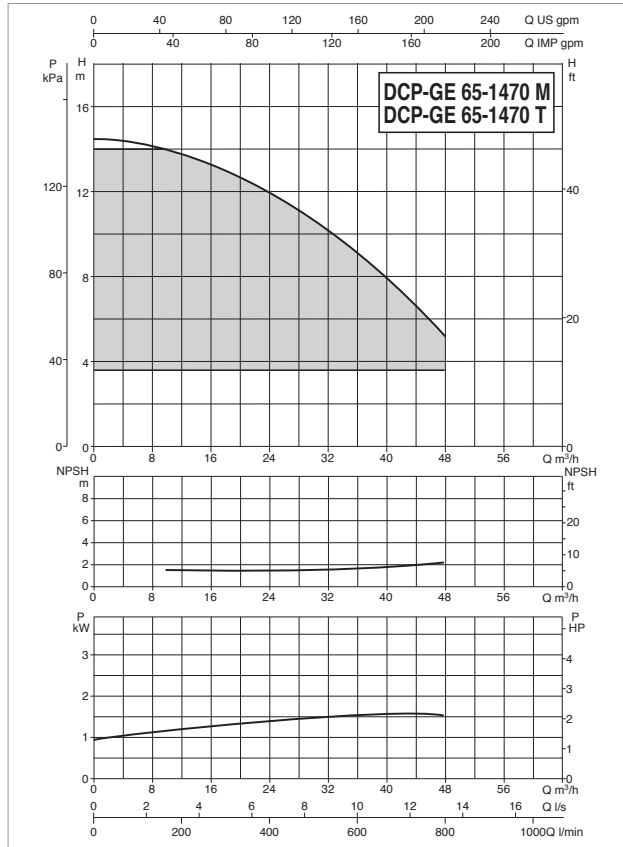

For the MEI index refer to the hydraulic data of the individual pump.

The performance curves are based on kinematic viscosity values = 1 mm<sup>2</sup>/s and density equal to 1000 kg/m<sup>3</sup>. Curve tolerance according to ISO 9906.

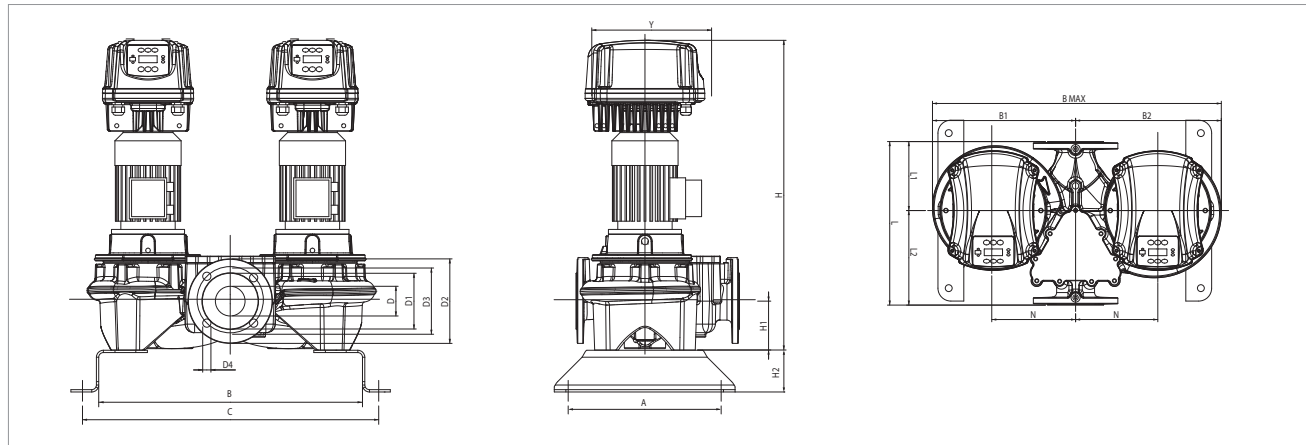

MODEL	ELECTRICAL DATA						
	POWER INPUT 50-60 Hz	MOTOR TYPE	n r.p.m.	P1 MAX W	P2 NOMINAL		In A
					kW	HP	
DCP-GE 65-1470/A/BAQE/ 1.5 M MCE11/C IE2	1 x 220-240 V ~	2 poles	2883	1,96	1,5	2,0	14,5
DCP-GE 65-1470/A/BAQE/ 1.5 T MCE30/C IE2	3 x 400 V ~	2 poles	2883	1,96	1,5	2,0	t.b.d.
DCP-GE 65-2280/A/BAQE/ 3 T MCE30/C IE2 *	3 x 400 V ~	2 poles	2882	3,55	3	4,0	7,2

\* ΔP-v proportional differential pressure adjustment mode also available.

MODEL	A	B	C	B1	B2	B max	D1	D2	D3	D4	no. of holes	Y	H	H1	H2	L	L1	L2	M	N	PACKING DIMENSIONS			VOL. (m <sup>3</sup> )	WEIGHT kg
																					L/A	L/B	H		
DCP-GE 65-1470/A/BAQE/ 1.5 M MCE11/C IE2	330	569	639	315	320	635	122	185	145	18	4	262	745	107	100	358	151	207	M16	180	405	700	848	0,24	150
DCP-GE 65-1470/A/BAQE/ 1.5 T MCE30/C IE2	330	569	639	315	320	635	122	185	145	18		262	748	107	100	358	151	207	M16	180	405	700	848	0,24	148
DCP-GE 65-2280/A/BAQE/ 3 T MCE30/C IE2	330	569	639	315	320	635	122	185	145	18		352	828	107	100	358	151	207	M16	180	405	750	925	0,28	193

# DCP-GE 65 2 POLES - ELECTRONIC IN-LINE PUMPS FOR HEATING, AIR CONDITIONING, REFRIGERATION, SOLAR, AND SANITARY SYSTEMS - TWIN, FLANGED, WITH MCE/C INVERTER

Pumped liquid temperature range: from -10 °C to +140°C - Maximum ambient temperature: +40°C

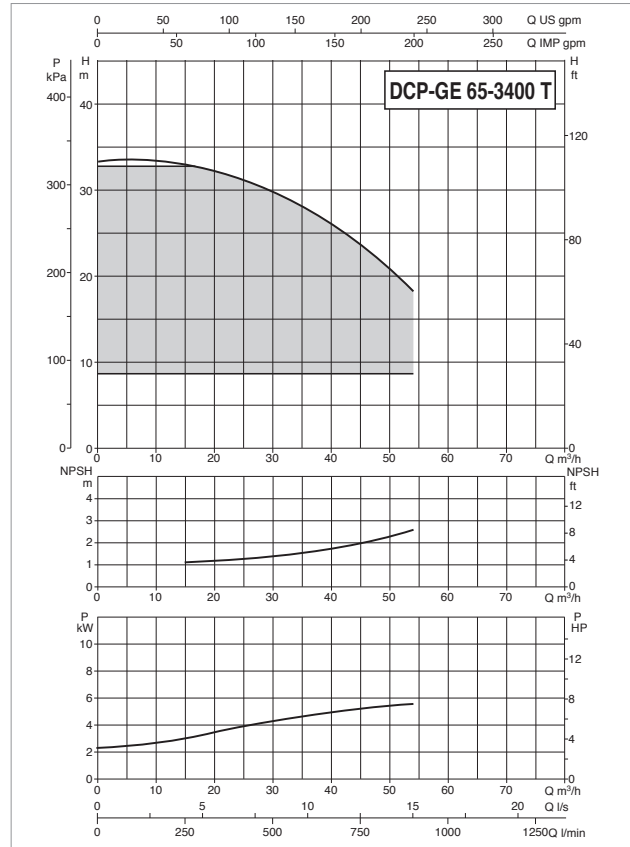
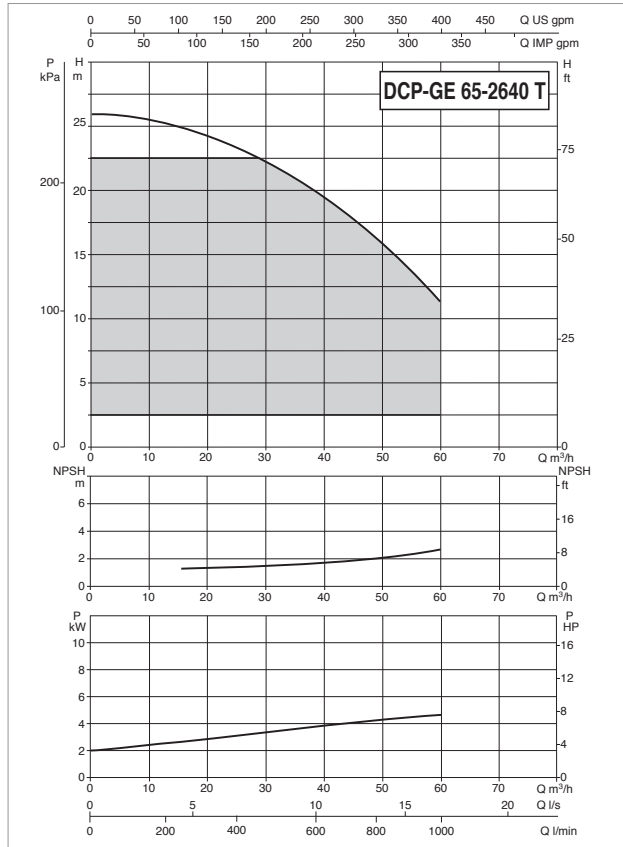

For the MEI index refer to the hydraulic data of the individual pump.

The performance curves are based on kinematic viscosity values = 1 mm<sup>2</sup>/s and density equal to 1000 kg/m<sup>3</sup>. Curve tolerance according to ISO 9906.

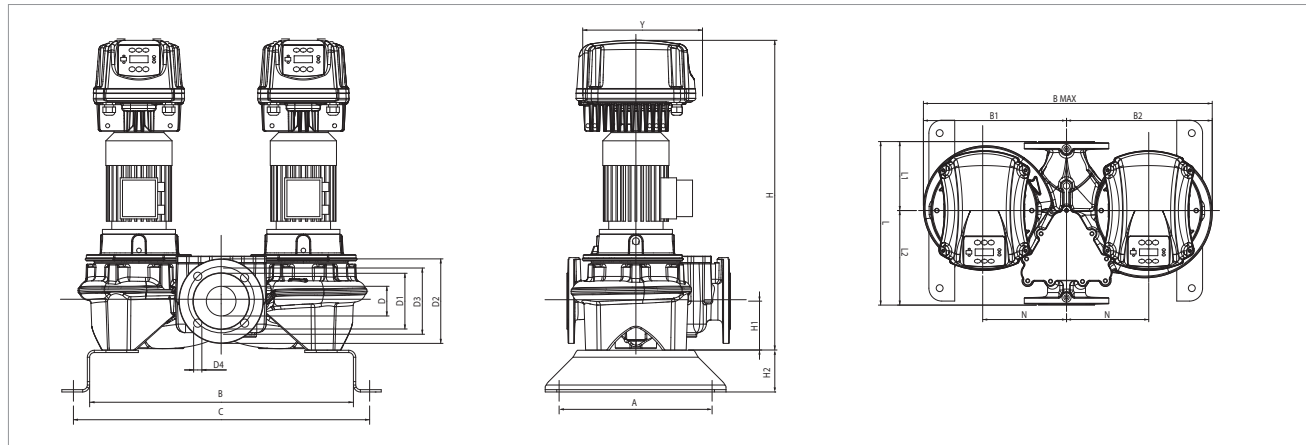

MODEL	ELECTRICAL DATA						
	POWER INPUT 50-60 Hz	MOTOR TYPE	n r.p.m.	P1 MAX W	P2 NOMINAL		In A
					kW	HP	
DCP-GE 65-2640/A/BAQE/ 4 T MCE55/C IE2 *	3 x 400 V ~	2 poles	2910	4,92	4	5,5	10,0
DCP-GE 65-3400/A/BAQE/ 5.5 T MCE55/C IE2 *	3 x 400 V ~	2 poles	2913	6,94	5,5	7,7	13,7

\* ΔP-v proportional differential pressure adjustment mode also available.

MODEL	A	B	C	B1	B2	B max	D1	D2	D3	D4	no. of holes	Y	H	H1	H2	L	L1	L2	M	N	PACKING DIMENSIONS			VOL. (m <sup>3</sup> )	WEIGHT kg
																					L/A	L/B	H		
DCP-GE 65-2640/A/BAQE/ 4 T MCE55/C IE2	330	569	639	315	320	635	122	185	145	18	4	352	843	107	100	358	151	207	M16	180	405	700	943	0,27	206
DCP-GE 65-3400/A/BAQE/ 5.5 T MCE55/C IE2	330	569	639	324	329	653	122	185	145	18		352	932	107	100	358	151	207	M16	180	405	700	1032	0,29	272

# DCP-GE 65 2 POLES - ELECTRONIC IN-LINE PUMPS FOR HEATING, AIR CONDITIONING, REFRIGERATION, SOLAR, AND SANITARY SYSTEMS - TWIN, FLANGED, WITH MCE/C INVERTER

Pumped liquid temperature range: from -10 °C to +140°C - Maximum ambient temperature: +40°C

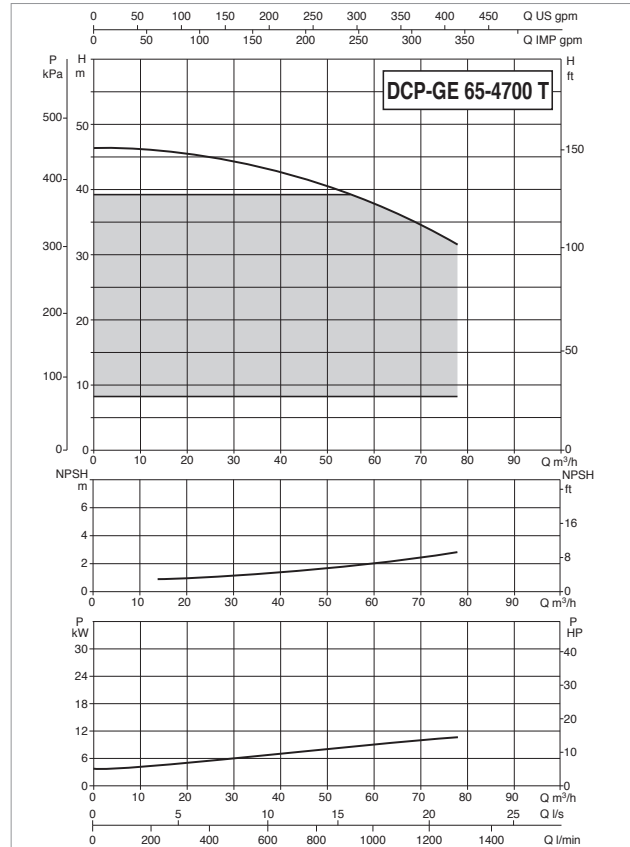
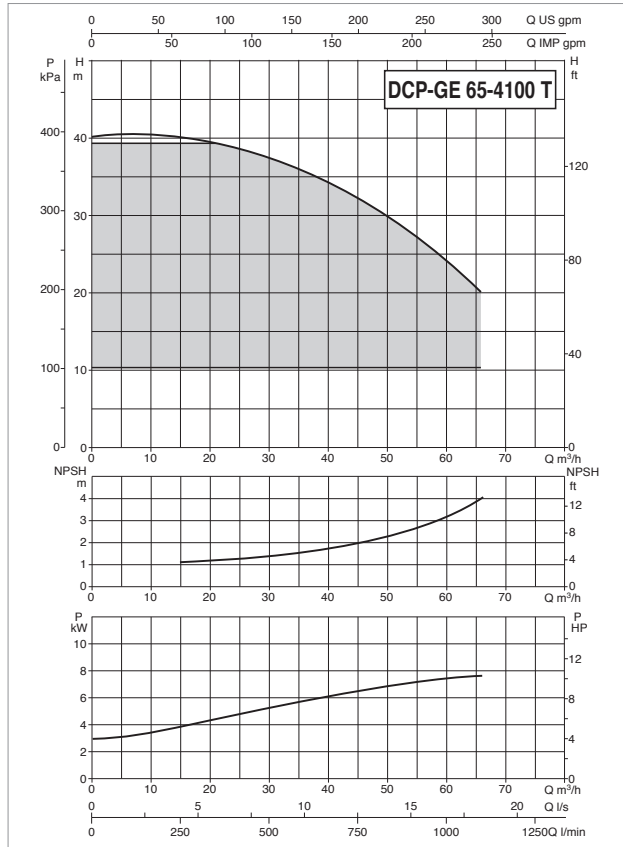

For the MEI index refer to the hydraulic data of the individual pump.

The performance curves are based on kinematic viscosity values = 1 mm²/s and density equal to 1000 kg/m³. Curve tolerance according to ISO 9906.

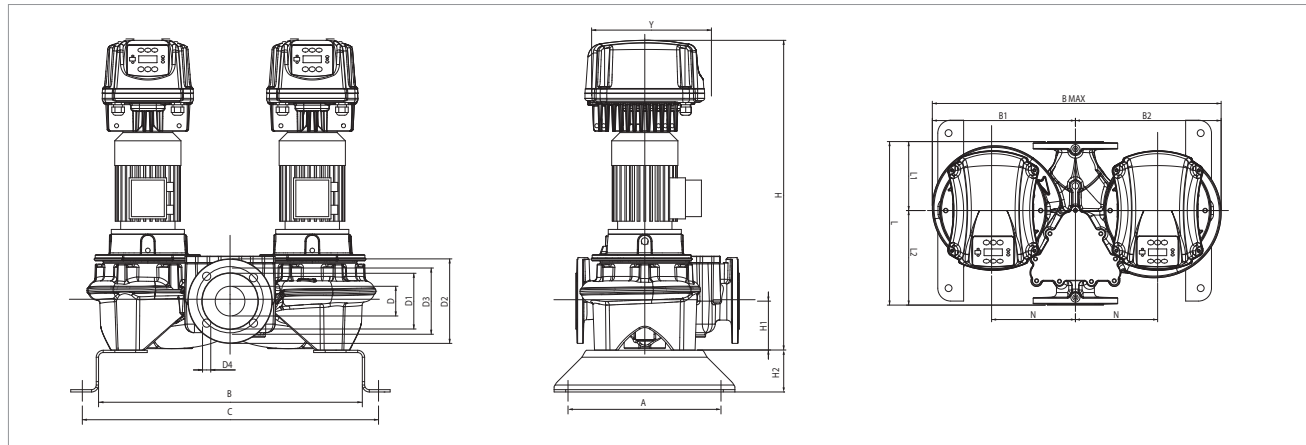

MODEL	ELECTRICAL DATA						
	POWER INPUT 50-60 Hz	MOTOR TYPE	n r.p.m.	P1 MAX W	P2 NOMINAL		In A
					kW	HP	
DCP-GE 65-4100/A/BAQE/ 7.5 T MCE110/C IE2 *	3 x 400 V ~	2 poles	2900	9,07	7,5	10,0	17,8
DCP-GE 65-4700/A/BAQE/ 11 T MCE110/C IE2	3 x 400 V ~	2 poles	2940	14,75	11	15,0	28,6

\* ΔP-v proportional differential pressure adjustment mode also available.

MODEL	A	B	C	B1	B2	B max	D1	D2	D3	D4	no. of holes	Y	H	H1	H2	L	L1	L2	M	N	PACKING DIMENSIONS			VOL. (m³)	WEIGHT kg
																					L/A	L/B	H		
DCP-GE 65-4100/A/BAQE/ 7.5 T MCE110/C IE2	330	569	639	324	329	653	122	185	145	18	4	425	980	107	100	358	151	207	M17	180	405	700	1080	0,31	284
DCP-GE 65-4700/A/BAQE/ 11 T MCE110/C IE2	330	649	719	389	397	786	122	185	145	18		425	1139	125	100	475	177	298	M16	220	475	782	1239	0,46	423



# DCP-GE 65 2 POLES - ELECTRONIC IN-LINE PUMPS FOR HEATING, AIR CONDITIONING, REFRIGERATION, SOLAR, AND SANITARY SYSTEMS - TWIN, FLANGED, WITH MCE/C INVERTER

Pumped liquid temperature range: from -10 °C to +140°C - Maximum ambient temperature: +40°C

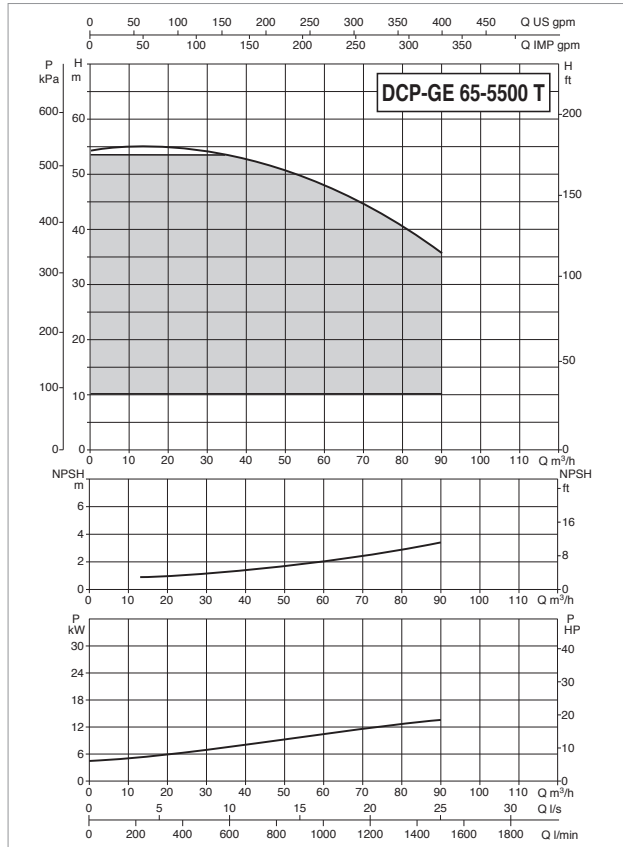

For the MEI index refer to the hydraulic data of the individual pump.

The performance curves are based on kinematic viscosity values = 1 mm²/s and density equal to 1000 kg/m³. Curve tolerance according to ISO 9906.

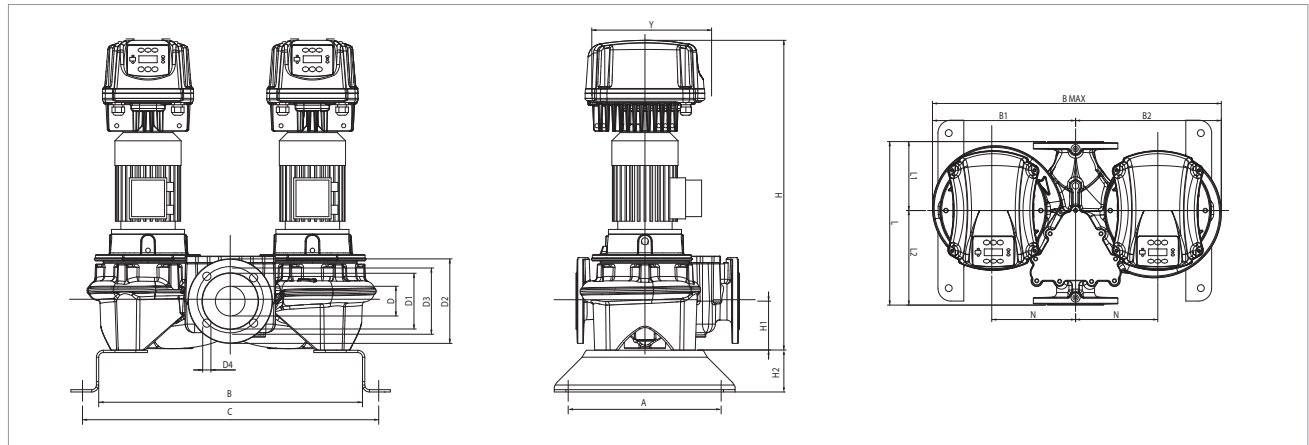

MODEL	ELECTRICAL DATA						
	POWER INPUT 50-60 Hz	MOTOR TYPE	n r.p.m.	P1 MAX W	P2 NOMINAL		In A
					kW	HP	
DCP-GE 65-5500/A/BAQE/ 15 T MCE150/C IE2 *	3 x 400 V ~	2 poles	2943	18,07	15	20,0	35,1

\* ΔP-v proportional differential pressure adjustment mode also available.

MODEL	A	B	C	B1	B2	B max	D1	D2	D3	D4	no. of holes	Y	H	H1	H2	L	L1	L2	M	N	PACKING DIMENSIONS			VOL. (m³)	WEIGHT kg
																					L/A	L/B	H		
																					DCP-GE 65-5500/A/BAQE/ 15 T MCE150/C IE2	330	649		

# DCP-GE 80 2 POLES - ELECTRONIC IN-LINE PUMPS FOR HEATING, AIR CONDITIONING, REFRIGERATION, SOLAR, AND SANITARY SYSTEMS - TWIN, FLANGED, WITH MCE/C INVERTER

Pumped liquid temperature range: from -10 °C to +140°C - Maximum ambient temperature: +40°C

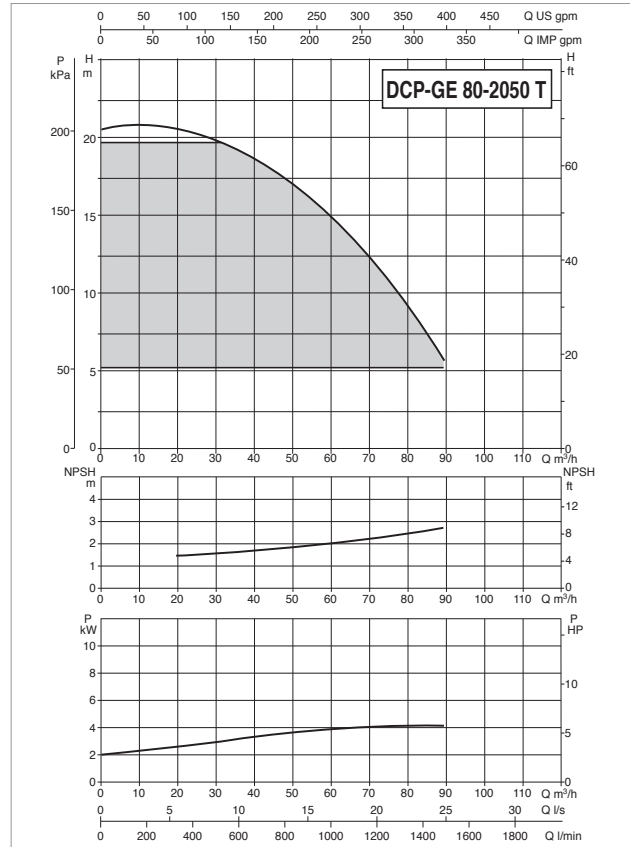
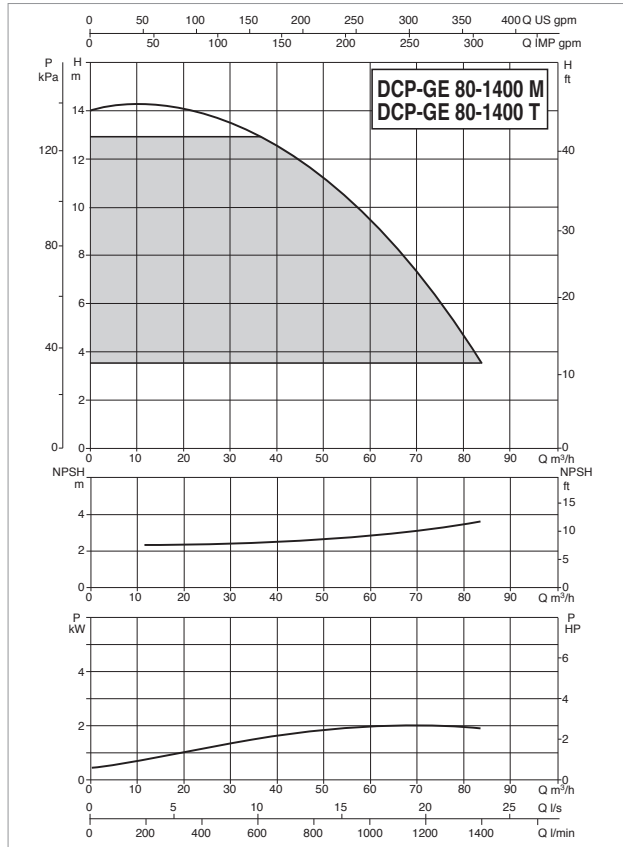

For the MEI index refer to the hydraulic data of the individual pump.

The performance curves are based on kinematic viscosity values = 1 mm²/s and density equal to 1000 kg/m³. Curve tolerance according to ISO 9906.

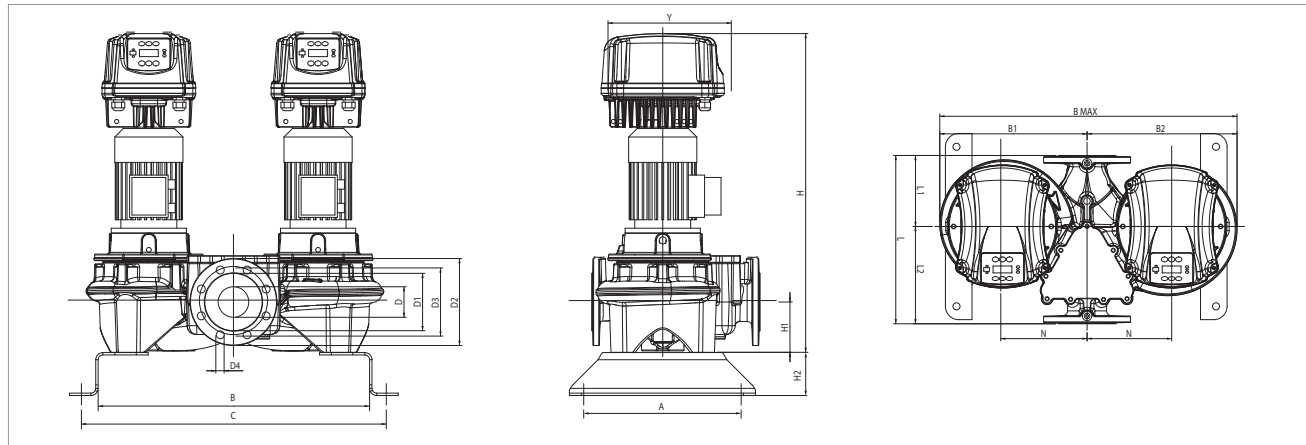

MODEL	ELECTRICAL DATA						
	POWER INPUT 50-60 Hz	MOTOR TYPE	n r.p.m.	P1 MAX W	P2 NOMINAL		In A
					kW	HP	
DCP-GE 80-1400/A/BAQE/ 2.2 M MCE22/C IE2	1 x 220-240 V ~	2 poles	2874	2,94	2,2	3,0	20,7
DCP-GE 80-1400/A/BAQE/ 2.2 T MCE30/C IE2	3 x 400 V ~	2 poles	2874	2,94	2,2	3,0	t.b.d.
DCP-GE 80-2050/A/BAQE/ 4 T MCE55/C IE2	3 x 400 V ~	2 poles	2914	5,46	4	5,5	10,9

MODEL	A	B	C	B1	B2	B max	D1	D2	D3	D4	no. of holes	Y	H	H1	H2	L	L1	L2	M	N	PACKING DIMENSIONS			VOL. (m³)	WEIGHT kg
																					L/A	L/B	H		
DCP-GE 80-1400/A/BAQE/ 2.2 M MCE22/C IE2	330	580	650	305	310	615	137	200	160	18	8	352	781,5	115	100	360	165	195	M16	180	360	710	882	0,23	177
DCP-GE 80-1400/A/BAQE/ 2.2 T MCE30/C IE2	330	580	650	305	310	615	137	200	160	18		352	781,5	115	100	360	165	195	M16	180	360	710	882	0,23	179
DCP-GE 80-2050/A/BAQE/ 4 T MCE55/C IE2	330	580	650	305	310	615	137	200	160	18		352	854,5	115	100	360	165	195	M16	180	360	710	955	0,24	195

# DCP-GE 80 2 POLES - ELECTRONIC IN-LINE PUMPS FOR HEATING, AIR CONDITIONING, REFRIGERATION, SOLAR, AND SANITARY SYSTEMS - TWIN, FLANGED, WITH MCE/C INVERTER

Pumped liquid temperature range: from -10 °C to +140°C - Maximum ambient temperature: +40°C

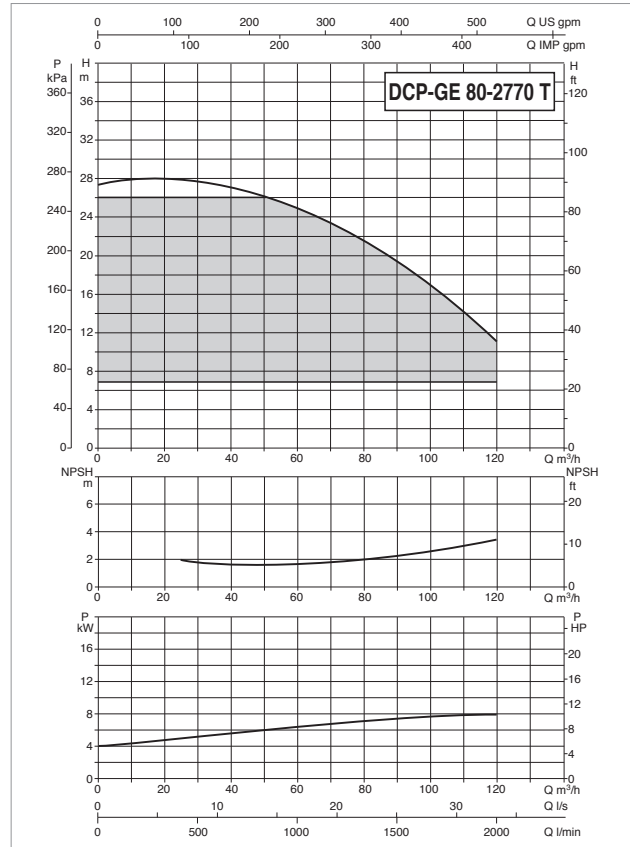
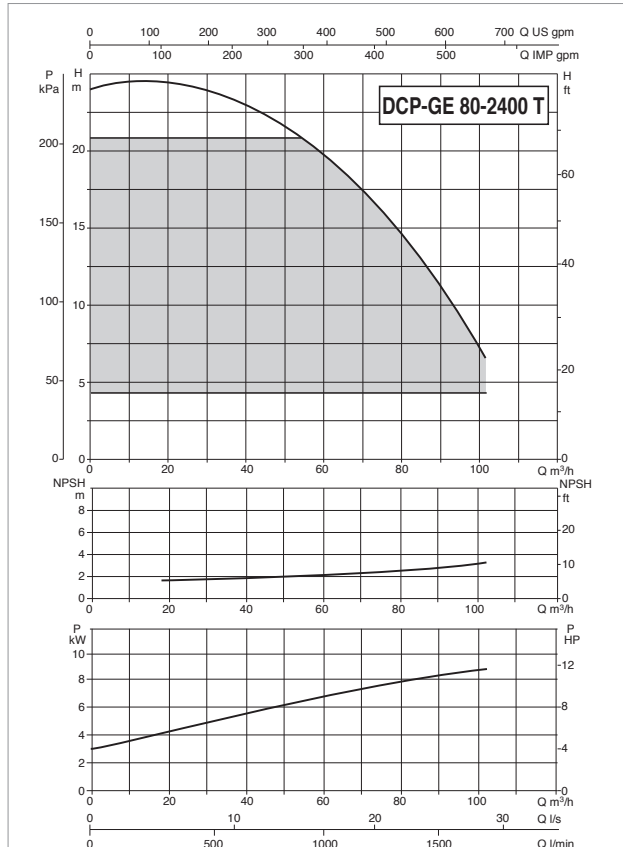

For the MEI index refer to the hydraulic data of the individual pump.

The performance curves are based on kinematic viscosity values = 1 mm²/s and density equal to 1000 kg/m³. Curve tolerance according to ISO 9906.

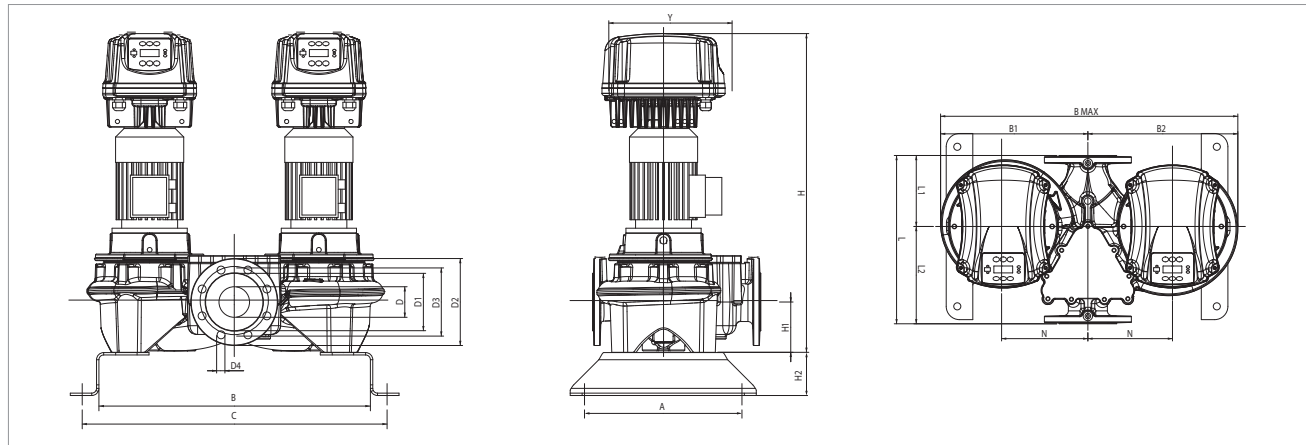

MODEL	ELECTRICAL DATA						
	POWER INPUT 50-60 Hz	MOTOR TYPE	n r.p.m.	P1 MAX W	P2 NOMINAL		In A
					kW	HP	
DCP-GE 80-2400/A/BAQE/ 5.5 T MCE55/C IE2 *	3 x 400 V ~	2 poles	2910	6,69	5,5	7,5	13,3
DCP-GE 80-2770/A/BAQE/ 7.5 T MCE110/C IE2 *	3 x 400 V ~	2 poles	2905	9,61	7,5	10,0	18,8

\* ΔP-v proportional differential pressure adjustment mode also available.

MODEL	A	B	C	B1	B2	B max	D1	D2	D3	D4	no. of holes	Y	H	H1	H2	L	L1	L2	M	N	PACKING DIMENSIONS			VOL. (m³)	WEIGHT kg
																					L/A	L/B	H		
DCP-GE 80-2400/A/BAQE/ 5.5 T MCE55/C IE2	330	580	650	327	332	659	137	200	160	18	8	352	943,5	115	100	360	165	195	M16	180	360	710	1044	0,27	264
DCP-GE 80-2770/A/BAQE/ 7.5 T MCE110/C IE2	330	620	690	355	365	750	137	200	160	18		425	992	115	100	440	165	195	M16	180	440	750	1092	0,36	186

# DCP-GE 80 2 POLES - ELECTRONIC IN-LINE PUMPS FOR HEATING, AIR CONDITIONING, REFRIGERATION, SOLAR, AND SANITARY SYSTEMS - TWIN, FLANGED, WITH MCE/C INVERTER

Pumped liquid temperature range: from -10 °C to +140°C - Maximum ambient temperature: +40°C

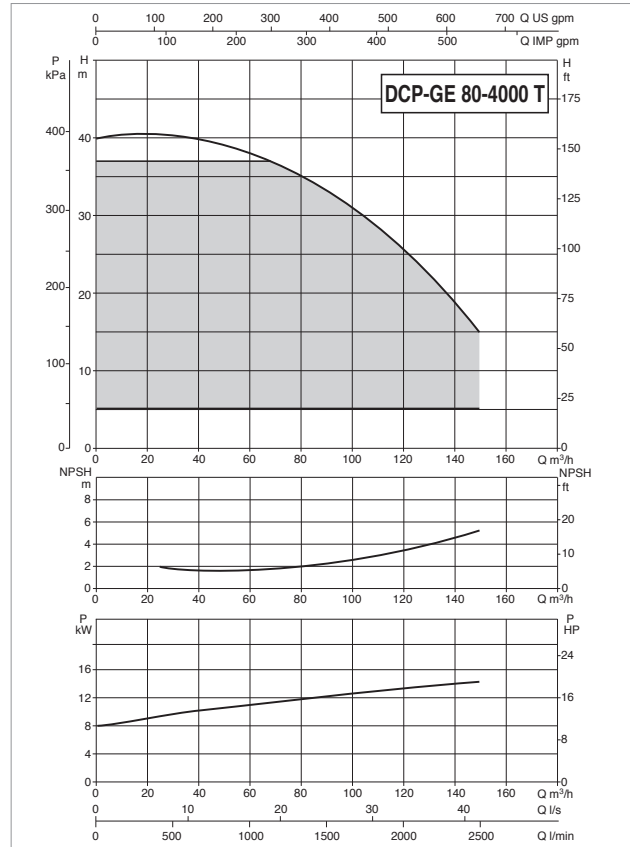
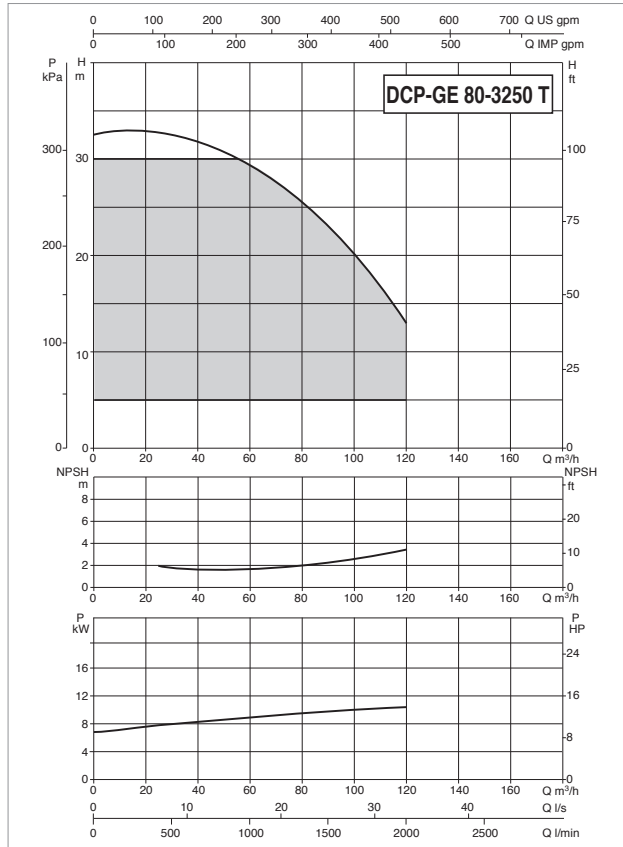

For the MEI index refer to the hydraulic data of the individual pump.

The performance curves are based on kinematic viscosity values = 1 mm<sup>2</sup>/s and density equal to 1000 kg/m<sup>3</sup>. Curve tolerance according to ISO 9906.

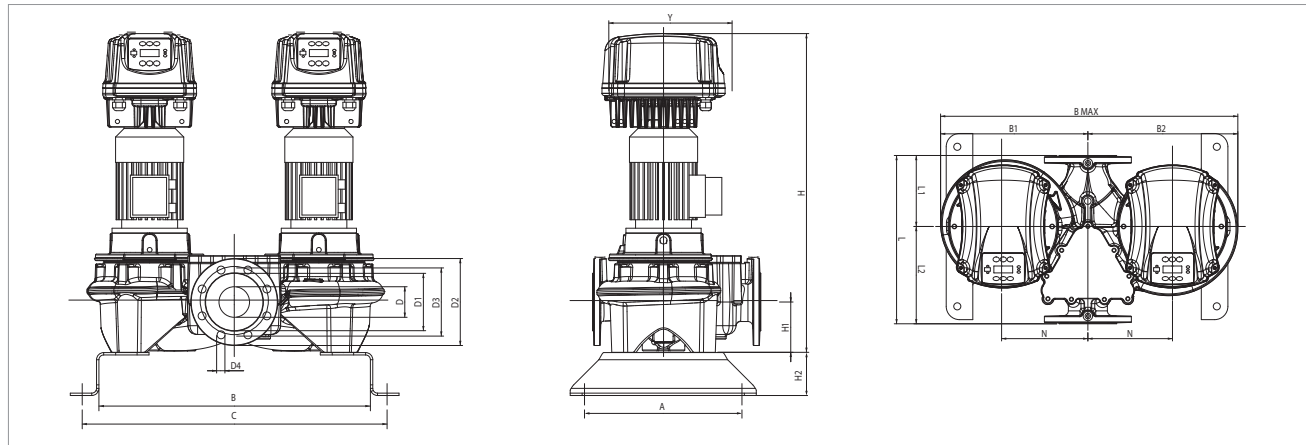

MODEL	ELECTRICAL DATA						
	POWER INPUT 50-60 Hz	MOTOR TYPE	n r.p.m.	P1 MAX W	P2 NOMINAL		In A
					kW	HP	
DCP-GE 80-3250/A/BAQE/ 11 T MCE110/C IE2	3 x 400 V ~	2 poles	2932	13,39	11	15,0	26,0
DCP-GE 80-4000/A/BAQE/ 15 T MCE150/C IE2 *	3 x 400 V ~	2 poles	2945	18,42	15	20,0	35,7

\* ΔP-v proportional differential pressure adjustment mode also available.

MODEL	A	B	C	B1	B2	B max	D1	D2	D3	D4	no. of holes	Y	H	H1	H2	L	L1	L2	M	N	PACKING DIMENSIONS			VOL. (m <sup>3</sup> )	WEIGHT kg
																					L/A	L/B	H		
DCP-GE 80-3250/A/BAQE/ 11 T MCE110/C IE2	330	620	690	364	374	768	137	200	160	18	8	425	1137	115	100	440	165	195	M16	180	440	768	1237	0,42	204
DCP-GE 80-4000/A/BAQE/ 15 T MCE150/C IE2	330	620	690	364	374	768	137	200	160	18	8	425	1137	115	100	440	165	195	M16	180	440	768	1237	0,42	214

# DCP-GE 100 2 POLES - ELECTRONIC IN-LINE PUMPS FOR HEATING, AIR CONDITIONING, REFRIGERATION, SOLAR, AND SANITARY SYSTEMS - TWIN, FLANGED, WITH MCE/C INVERTER

Pumped liquid temperature range: from -10 °C to +140°C - Maximum ambient temperature: +40°C

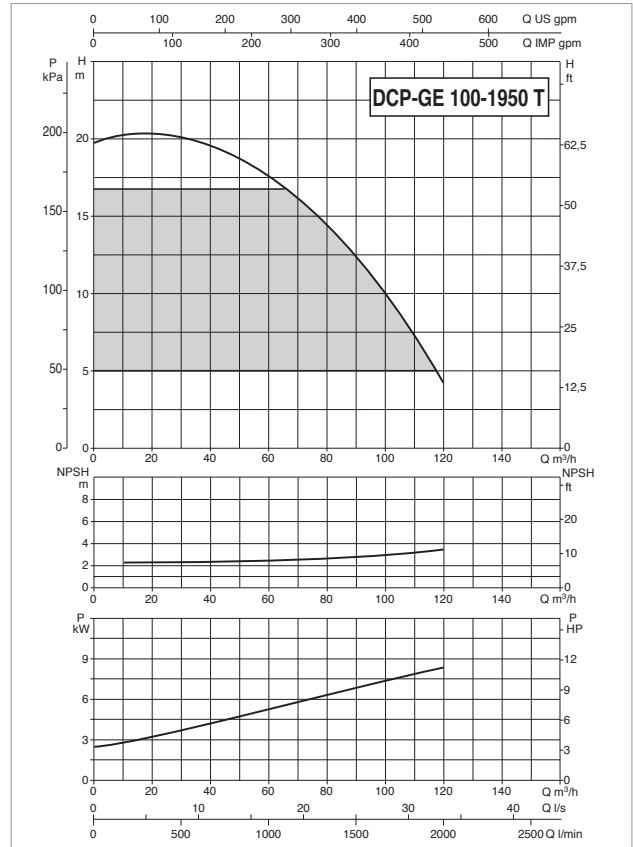
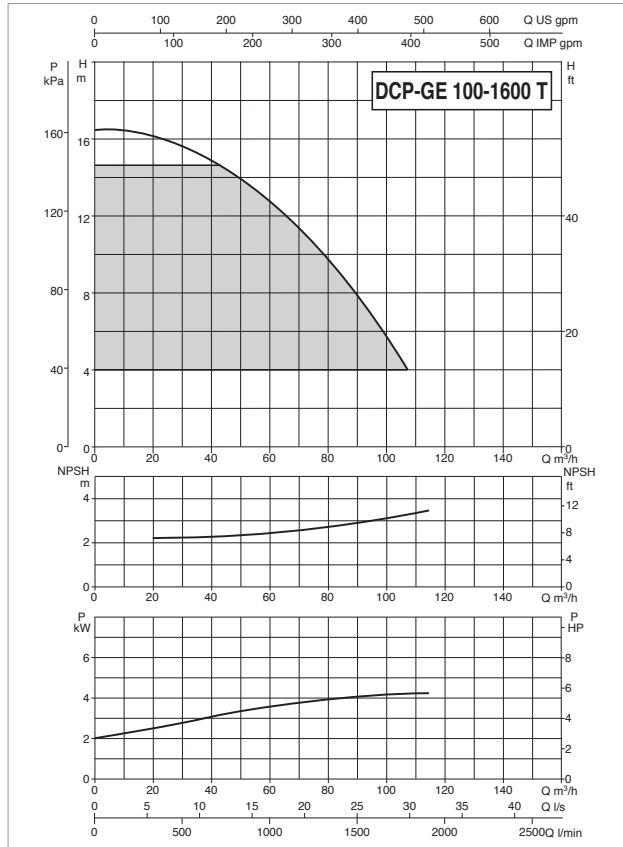

For the MEI index refer to the hydraulic data of the individual pump.

The performance curves are based on kinematic viscosity values = 1 mm²/s and density equal to 1000 kg/m³. Curve tolerance according to ISO 9906.

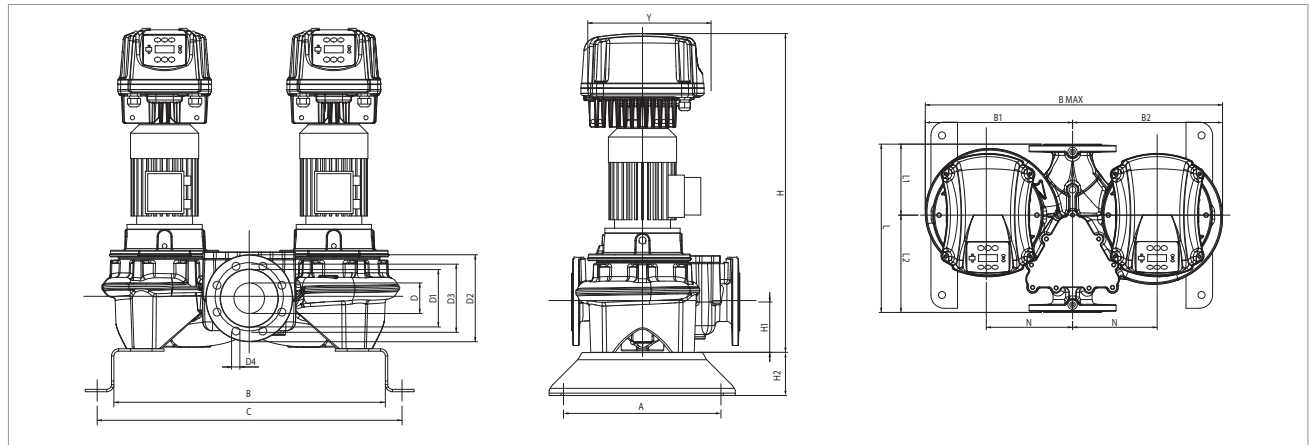

MODEL	ELECTRICAL DATA						
	POWER INPUT 50-60 Hz	MOTOR TYPE	n r.p.m.	P1 MAX W	P2 NOMINAL		In A
					kW	HP	
DCP-GE 100-1600/A/BAQE/ 4 T MCE55/C IE2	3 x 400 V ~	2 poles	2918	5,58	4	5,5	11,2
DCP-GE 100-1950/A/BAQE/ 5.5 T MCE55/C IE2	3 x 400 V ~	2 poles	2918	7,34	5,5	7,5	14,4

MODEL	A	B	C	B1	B2	B max	D1	D2	D3	D4	no. of holes	Y	H	H1	H2	L	L1	L2	M	N	PACKING DIMENSIONS			VOL. (m³)	WEIGHT kg
																					L/A	L/B	H		
DCP-GE 100-1600/A/BAQE/ 4 T MCE55/C IE2	362	637	717	330	345	675	137	200	160	18	8	352	882,5	140	100	500	280	340	M16	300	500	777	983	0,38	183
DCP-GE 100-1950/A/BAQE/ 5.5 T MCE55/C IE2	362	637	717	335	350	685	137	200	160	18		352	970,5	140	100	500	280	340	M16	300	500	777	1071	0,42	197

# DCP-GE 100 2 POLES - ELECTRONIC IN-LINE PUMPS FOR HEATING, AIR CONDITIONING, REFRIGERATION, SOLAR, AND SANITARY SYSTEMS - TWIN, FLANGED, WITH MCE/C INVERTER

Pumped liquid temperature range: from -10 °C to +140°C - Maximum ambient temperature: +40°C

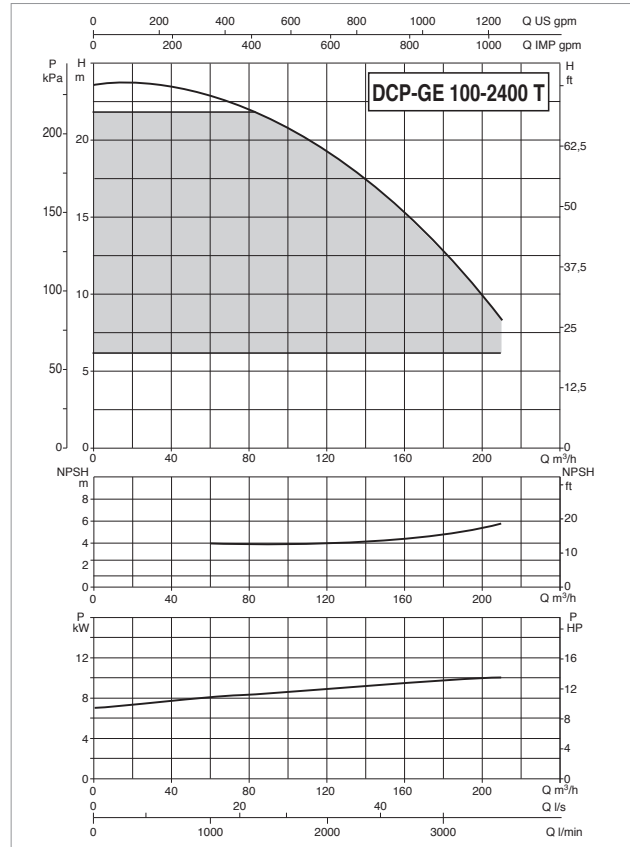
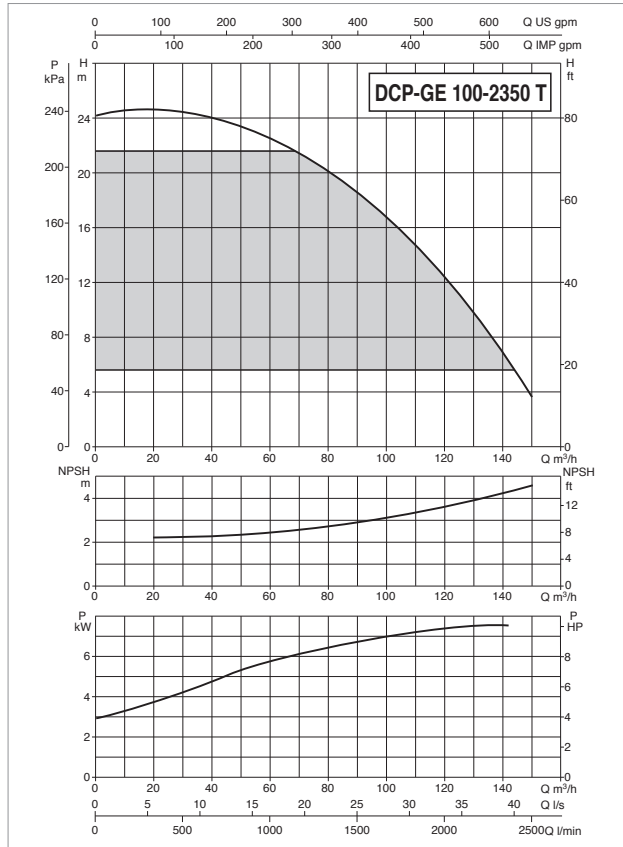

For the MEI index refer to the hydraulic data of the individual pump.

The performance curves are based on kinematic viscosity values = 1 mm²/s and density equal to 1000 kg/m³. Curve tolerance according to ISO 9906.

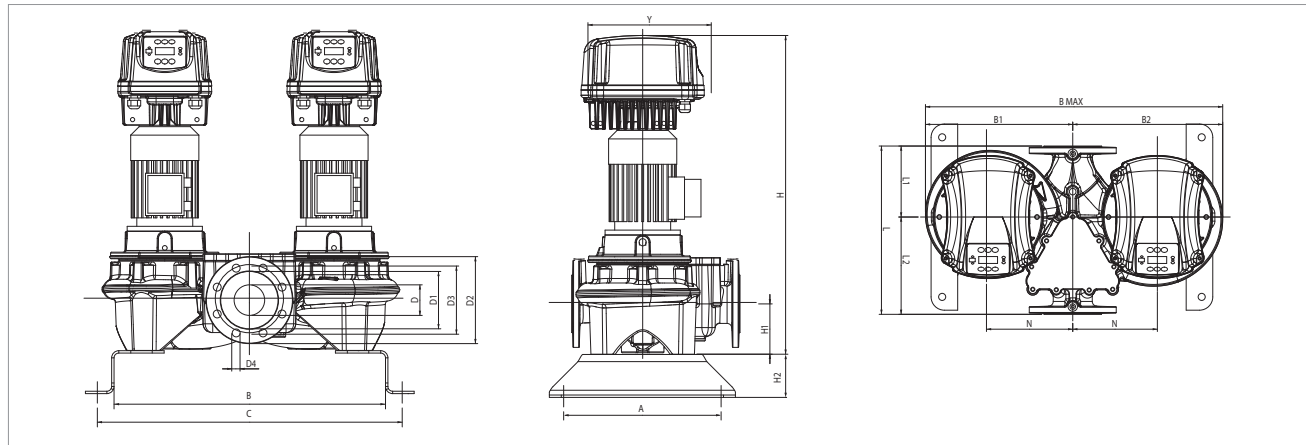

MODEL	ELECTRICAL DATA						
	POWER INPUT 50-60 Hz	MOTOR TYPE	n r.p.m.	P1 MAX W	P2 NOMINAL		In A
					kW	HP	
DCP-GE 100-2350/A/BAQE/ 7.5 T MCE110/C IE2 *	3 x 400 V ~	2 poles	2906	9,69	7,5	10,0	18,9
DCP-GE 100-2400/A/BAQE/ 11 T MCE110/C IE2	3 x 400 V ~	2 poles	2940	14,59	11	15,0	28,3

\* ΔP-v proportional differential pressure adjustment mode also available.

MODEL	A	B	C	B1	B2	B max	D1	D2	D3	D4	no. of holes	Y	H	H1	H2	L	L1	L2	M	N	PACKING DIMENSIONS			VOL. (m³)	WEIGHT kg
																					L/A	L/B	H		
DCP-GE 100-2350/A/BAQE/ 7.5 T MCE110/C IE2	362	637	717	335	350	685	137	200	160	18	8	425	1018,5	140	100	500	280	340	M16	300	500	777	1119	0,43	230
DCP-GE 100-2400/A/BAQE/ 11 T MCE110/C IE2	362	733	813	395	410	805	156	220	180	18		425	1159	140	100	550	191	309	M16	200	550	873	1259	0,60	273

# DCP-GE 100 2 POLES - ELECTRONIC IN-LINE PUMPS FOR HEATING, AIR CONDITIONING, REFRIGERATION, SOLAR, AND SANITARY SYSTEMS - TWIN, FLANGED, WITH MCE/C INVERTER

Pumped liquid temperature range: from -10 °C to +140°C - Maximum ambient temperature: +40°C

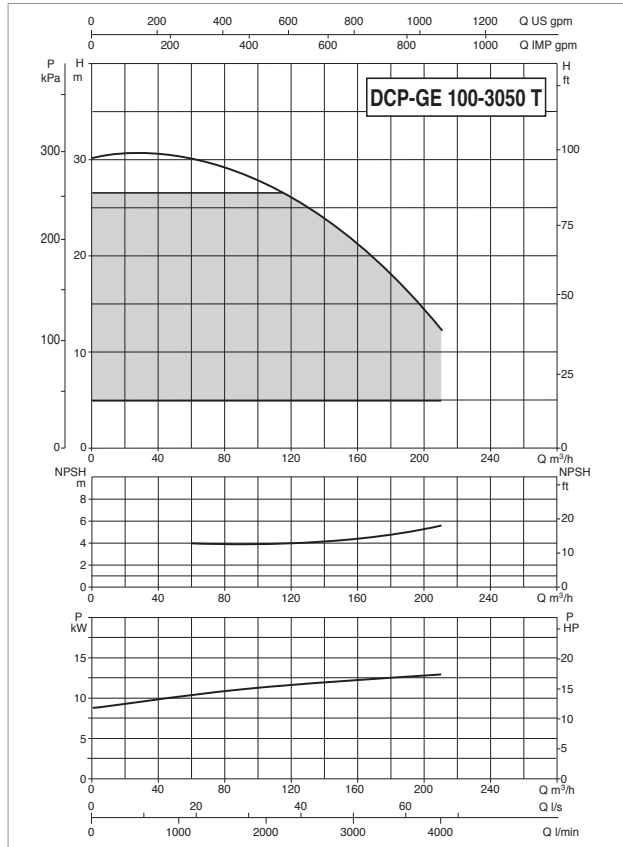

For the MEI index refer to the hydraulic data of the individual pump.

The performance curves are based on kinematic viscosity values = 1 mm<sup>2</sup>/s and density equal to 1000 kg/m<sup>3</sup>. Curve tolerance according to ISO 9906.

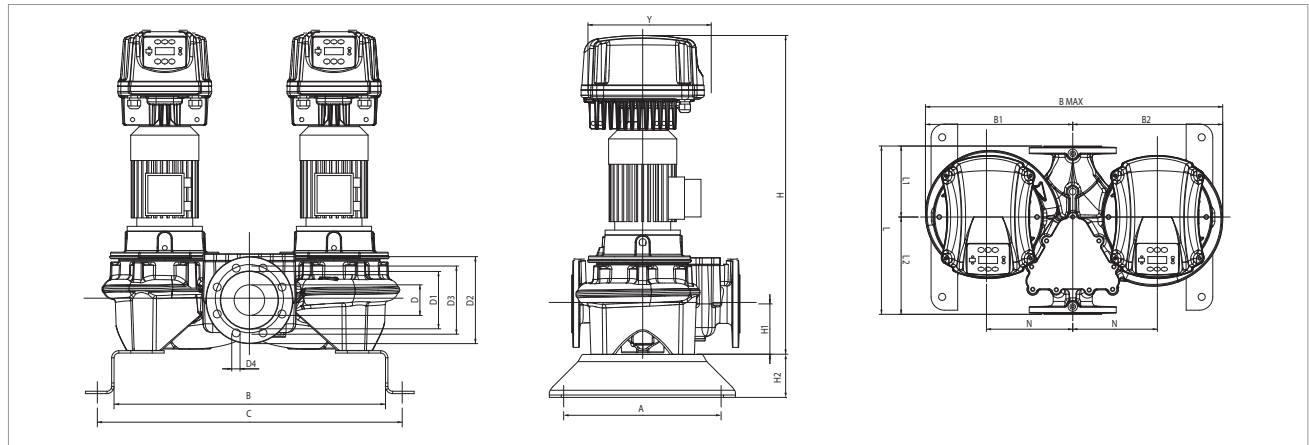

MODEL	ELECTRICAL DATA						
	POWER INPUT 50-60 Hz	MOTOR TYPE	n r.p.m.	P1 MAX W	P2 NOMINAL		In A
					kW	HP	
DCP-GE 100-3050/A/BAQE/ 15 T MCE150/C IE2 *	3 x 400 V ~	2 poles	2941	17,79	15	20,0	34,6

\* ΔP-v proportional differential pressure adjustment mode also available.

MODEL	A	B	C	B1	B2	B max	D1	D2	D3	D4	no. of holes	Y	H	H1	H2	L	L1	L2	M	N	PACKING DIMENSIONS			VOL. (m <sup>3</sup> )	WEIGHT kg
	L/A	L/B	H	L/A	L/B	H																			
DCP-GE 100-3050/A/BAQE/ 15 T MCE150/C IE2	362	733	813	395	410	805	156	220	180	18	8	425	1159	140	100	550	191	309	M16	200	550	873	1259	0,60	352