

KLME / KLPE / DKLME / DKLPE

ELECTRONIC IN-LINE PUMPS FOR CIRCULATION SYSTEMS



TECHNICAL DATA

Operating range:

from 2 to 67 m³/h with head up to 13,7 metres.

Pumped liquid: clean, free of solids and abrasives, non-viscous, non-aggressive, non-crystallised and chemically neutral, with properties similar to water. Maximum glycol content 30% (for other glycol percentages contact Technical Support).

Pumped liquid temperature range: from -15 °C to +120°C.

Maximum ambient temperature: +40°C

Maximum operating pressure: 10 bar (1000 kPa).

Standard flanges:

DN 40, DN 50, DN 65, DN 80 - PN 6/PN 10 (4 holes)

Flanges on request: DN 80 - PN 16 (8 holes)

Counter flanges on request: threaded DN 40, DN 50, DN 65 - PN 6

with welded collar DN 40, DN 50, DN 65, DN 80 - PN 6

with welded collar DN 40, DN 50, DN 65 - PN 10/PN 16 (4 holes)

with welded collar DN 80 - PN 10/PN 16 (8 holes)

Protection class: IP 55

Insulation class: F

Standard single-phase voltage: 1x220-240 V / 50-60 Hz

Special version on request:

three-phase 3x400 V / 50 Hz or three-phase 3x460 V / 60 Hz

Standard three-phase voltage: 3x400 V / 50 Hz

Special version on request: 3x460 V / 60 Hz

APPLICATIONS

Hot or cold water circulation pump with in-line ports, suitable for installation directly on the pipework of on civil and industrial heating, air conditioning, refrigeration, and sanitary water plants. Particularly versatile thanks to the use of the MCE/C inverter, offering performance features capable of automatically adapting to the different needs of the system, keeping a consistent differential pressure.

CONSTRUCTION FEATURES OF THE PUMP

Pump body and motor support in cast iron.

PN 10 flanged suction and delivery ports with threaded holes for control manometers. To make replacement in existing systems easier, the pump can accept PN 6 counter flanges.

Technopolymer impeller.

Carbon/ceramic mechanical seal.

The pumps are available both in the single (KLME-KLPE) and in the twin (DKLME-DKLPE) versions.

For the single version a built in clapet valve in the delivery port is also included, to avoid water recirculation when the unit is idle. A blind flange is also supplied as a standard, to be used during maintenance of one of the two motors.

The twin version gives the possibility of alternating the operation of the pumps when a backup unit is required, or to have the two pumps operating simultaneously.

CONSTRUCTION FEATURES OF THE MOTOR

External ventilation cooling, closed, asynchronous type, with four poles for the KLME and DKLME versions, and two poles for the KLPE and DKLPE versions.

Rotor running on permanently lubricated ball bearings, oversized to ensure low noise and durability.

Built-in thermo-amperometric protection.

Construction according to CEI 2-3.

CONSTRUCTION FEATURES OF THE ELECTRONICS: MCE/C INVERTER

MCE/C inverters are the latest technological achievement of the DAB inverter range. They represent a new generation of inverters for use with circulation pumps, and set themselves apart due to ease of use, power, simplicity of installation and management. MCE/C inverters have been designed for managing circulation pumps. By allowing a simple adjustment of the differential pressure, they give the possibility of adjusting the performance of the circulation pump to the actual system requirements. They are fitted on the fan cover of the motor. This makes the installation of the pump with MCE/C particularly easy and quick. The protection class of the MCE/C is IP55. The ease of programming is guaranteed by the use of a simple and intuitive interface, similar to Dialogue electronic circulators, and a graphic display. MCE/C inverters have a double micro-processor construction that guarantees maximum efficiency and reliability.

A reliable and sturdy construction, together with a modern and innovative design, complete the product, also in terms of aesthetic value. MCE/C inverters protect the motor and the pump, and increase their life, by eliminating hammering effects and making the pump rotate at the minimum number of rotations capable of meeting the requirements of the user. In addition, electric pumps controlled by the MCE/C inverter are environmentally friendly. In fact, by ensuring that the pump only uses the power that is strictly necessary for meeting the needs of the users, electricity consumption is strongly reduced when compared with fixed speed pumps. It is possible to create twin units by using the appropriate cable for the connection of MCE/C inverters.

KLME / KLPE / DKLME / DKLPE

ELECTRONIC IN-LINE PUMPS FOR CIRCULATION SYSTEMS

MATERIALS

N.	PARTS*	MATERIALS
1	PUMP BODY	CAST IRON 250 UNI ISO 185
3	SUPPORT	CAST IRON 250 UNI ISO 185
4	IMPELLER	TECHNOPOLYMER B
7	SHAFT WITH ROTOR	AISI 303 STAINLESS STEEL X10 CrNiS 1809 UNI 6900/71
16	MECHANICAL SEAL	CARBON / CERAMIC
28	OR RING	EPDM RUBBER

* In contact with the liquid

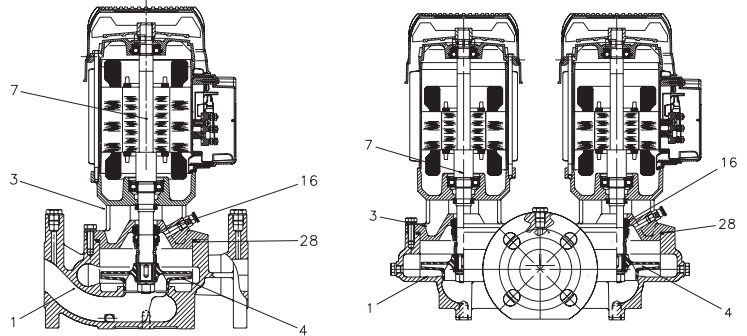

– Legend: (example)

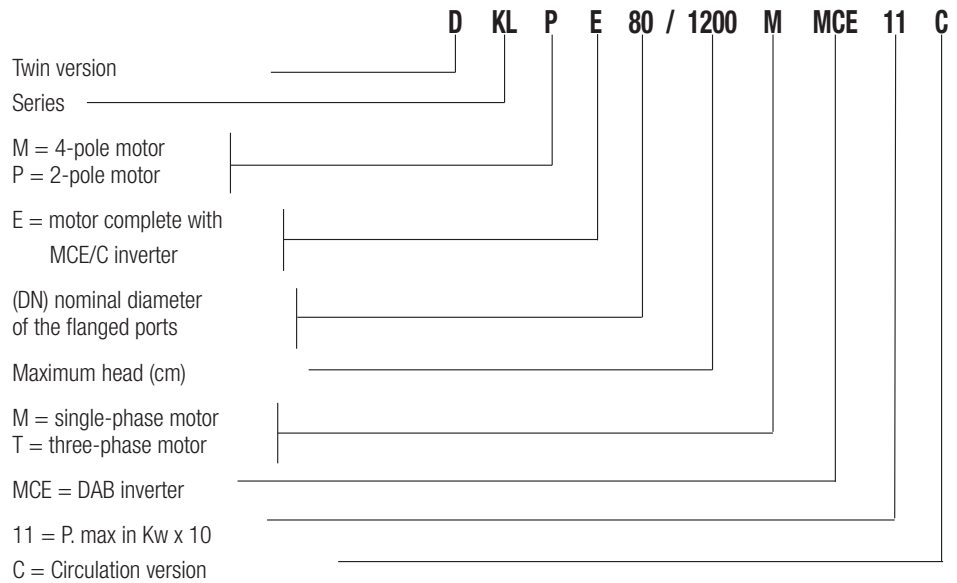

Installation: horizontal or vertical position, provided that the motor is always above the pump.

KLME / KLPE

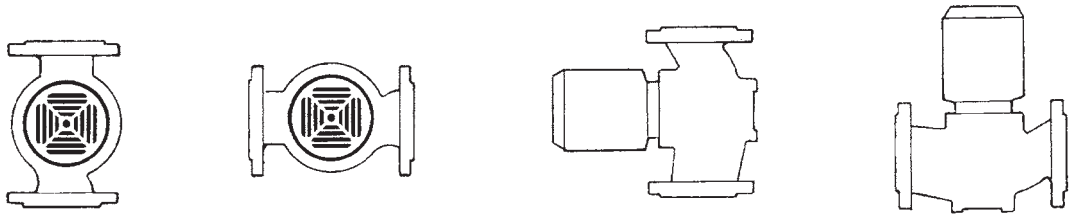

DKLME / DKLPE

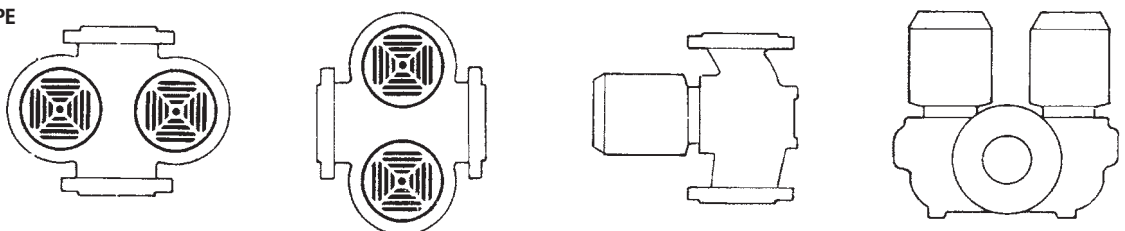

MCE/C INVERTER

MODES OF OPERATION

All the functions listed below can be consulted by the users (including less experienced ones) by simply scrolling through the MCE/C menu. The calibration and the modification of the parameters are protected, and can only be completed by expert users.

1 - ΔP -c constant differential pressure adjustment mode

The ΔP -c adjustment mode keeps the differential pressure of the system constantly at the H (setp) value set, even in case of variation of the flow rate. This is the standard adjustment used. It can be set directly from the MCE/C control panel. The inverter keeps the differential pressure (H setp) constant even in case of flow variation.

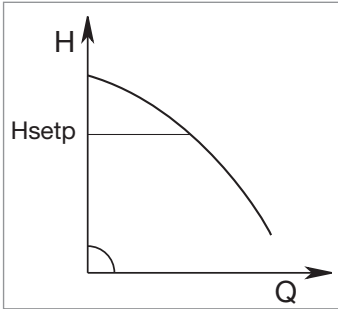

This adjustment is particularly indicated for the following systems:

- a. two-pipe heating systems with thermostat valves
- b. underfloor heating systems with thermostat valves
- c. single-pipe heating systems with thermostat valves and calibration valves
- d. systems with primary circuit pumps

2 - Constant curve adjustment modes

2.1 - Constant curve adjustment

The rotation speed is kept at a constant number of revolutions. This rotation speed can be set between a minimum value and the nominal frequency of the circulation pump (e.g. between 15 Hz and 50 Hz). This mode can be set using the control panel on the MCE cover.

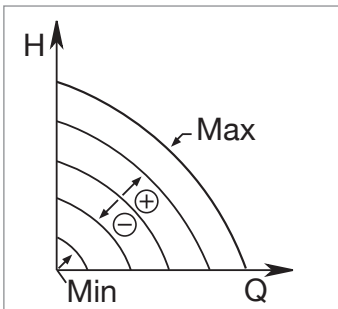

2.2 - Adjustment of the constant curve with external analogue signal

The rotation speed is kept at a constant number of revolution in proportion with the voltage of the external analogue signal.

The rotation speed changes in a linear way, between the nominal frequency of the pump when $V_{in} = 10$ V, and the minimum frequency when $V_{in} = 0$ V.

This mode can be set using the control panel on the MCE cover.

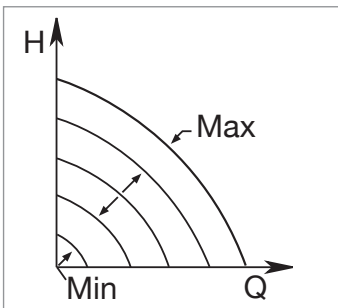

3 - ΔP -v * proportional differential pressure adjustment mode

With ΔP -v adjustment mode, with the variation of the flow rate, the value of the delivery of the head also varies in a linear manner, from Hsetp to Hsetp/2.

* in order to know the availability of the function on specific models contact our customer service.

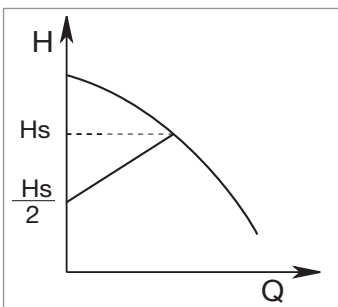

For more information refer to the technical appendix.

ELECTRIC IN-LINE PUMPS

ELECTRONIC IN-LINE PUMPS FOR CIRCULATION SYSTEMS

PERFORMANCE RANGE

The performance curves are based on kinematic viscosity values = 1 mm²/s and density equal to 1000 kg/m³. Curve tolerance according to ISO 9906.

GRAPHIC SELECTION TABLE

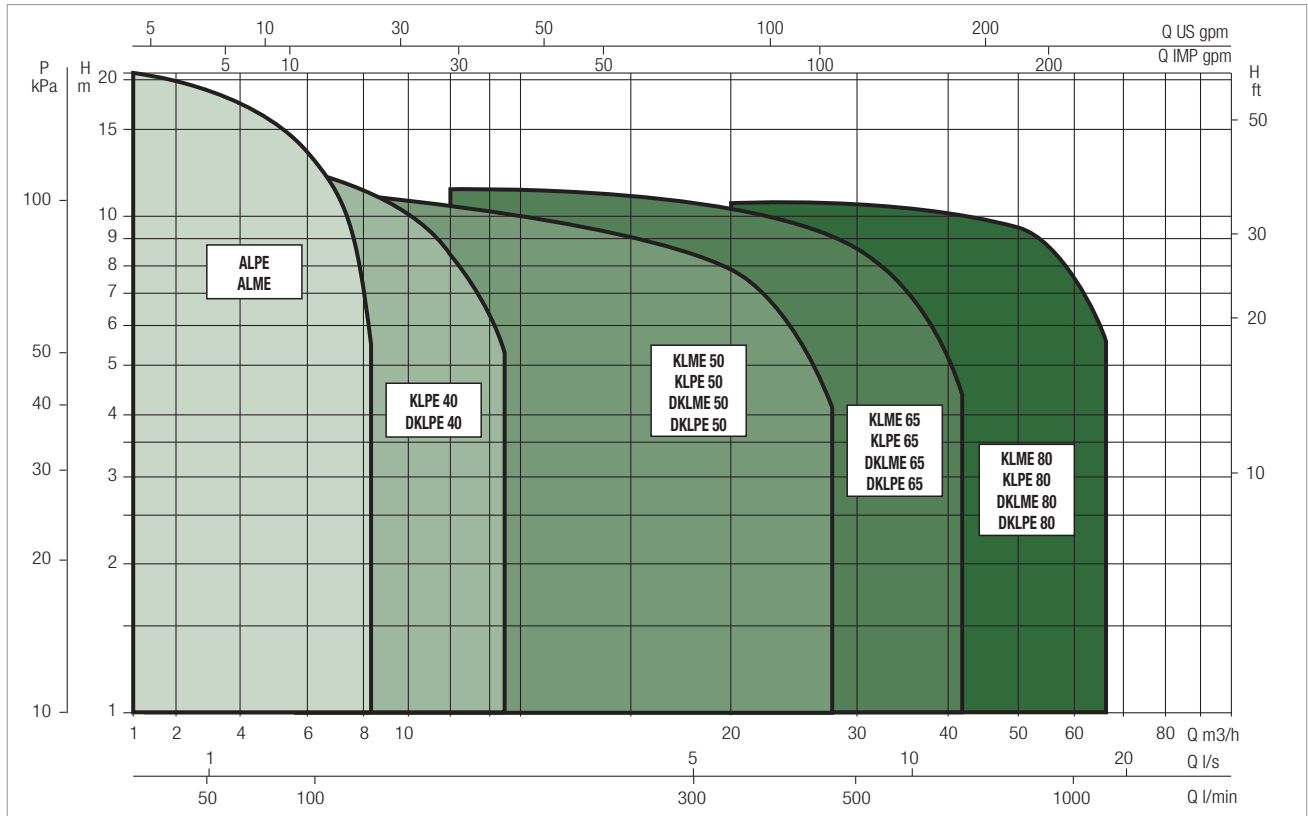

SELECTION TABLE - KLME / KLPE - DKLME / DKLPE

MODEL	Q=m ³ /h	0	4,8	6	7,2	8,4	9,6	12	18	30	36	48	
	Q=l/min	0	80	100	120	140	160	200	300	500	600	800	
KLPE - DKLPE 40- 600 M MCE11/C	H (m)	8,2	7,8	7,4	6,9	6,3	5,7	4					
KLPE - DKLPE 40-1200 M MCE11/C		13,7	13,2	12,6	11,9	11,2	10,4	8,4					
KLME - DKLPE 50-600 M MCE11/C		5,4	5,2	4,9	4,7	4,5	4,3	3,8	2				
KLPE - DKLPE 50-1200 M MCE11/C		12			11,8	11,6	11	10,5	8,6				
KLME - DKLPE 65-600 M MCE11/C		5,5				5,3	5	4,7	3,8				
KLPE - DKLPE 65-1200 M MCE11/C		12						11,6	11	8,8	6,7		
KLPE - DKLPE 65-1200 T MCE30/C		12						11,6	11	8,8	6,7		
KLME - DKLPE 80-600 M MCE11/C		5,7							5,7	5	4,3	2,5	
KLPE - DKLPE 80-1200 M MCE22/C		11,8									11,5	11	9,7
KLPE - DKLPE 80-1200 T MCE30/C		11,8									11,5	11	9,7

DKLPE 40 - IN-LINE ELECTRIC PUMPS FOR HEATING, AIR CONDITIONING, REFRIGERATION, SOLAR, AND SANITARY SYSTEMS - TWIN, FLANGED, WITH MCE/C INVERTER

Pumped liquid temperature range: from -15 °C to +120 °C - Maximum ambient temperature: +40°C

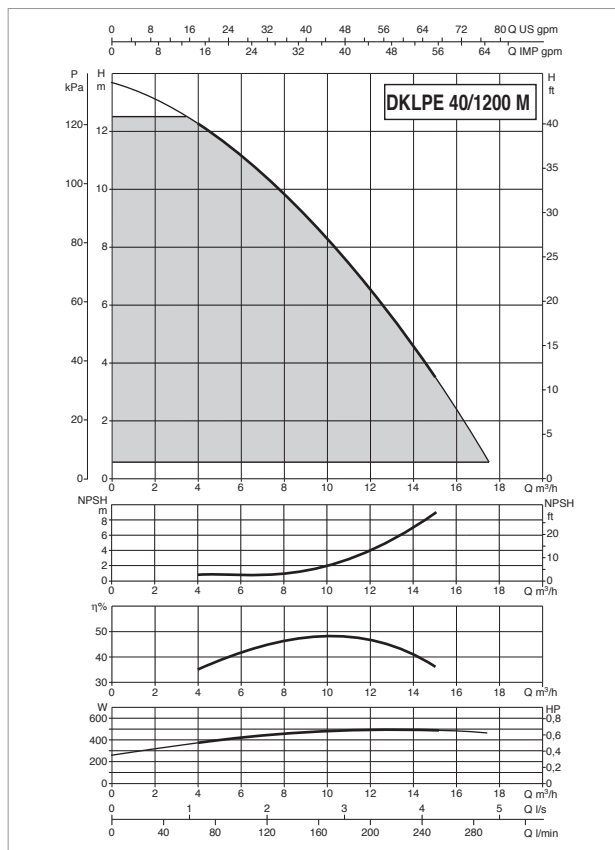
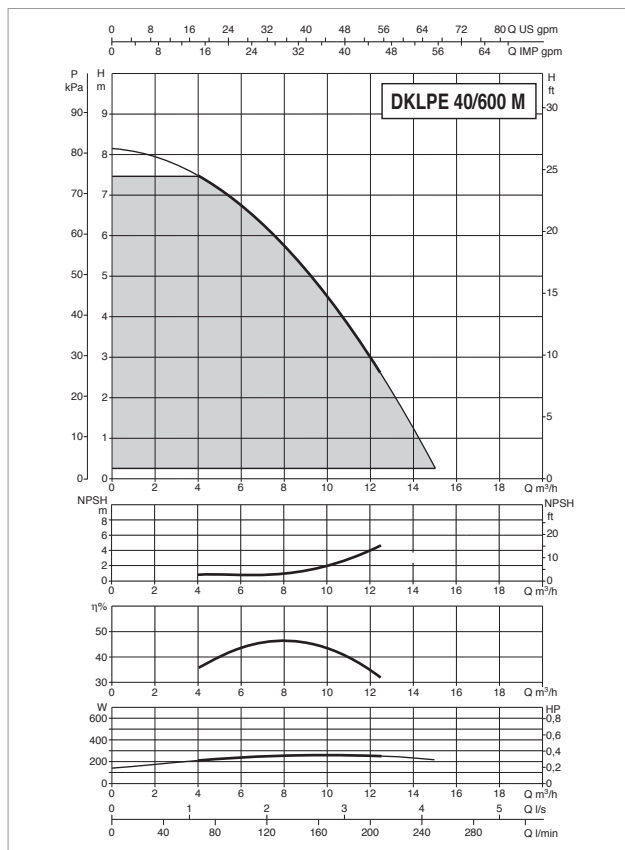

For the MEI index refer to the hydraulic data of the individual pump.

The performance curves are based on kinematic viscosity values = 1 mm²/s and density equal to 1000 kg/m³. Curve tolerance according to ISO 9906.

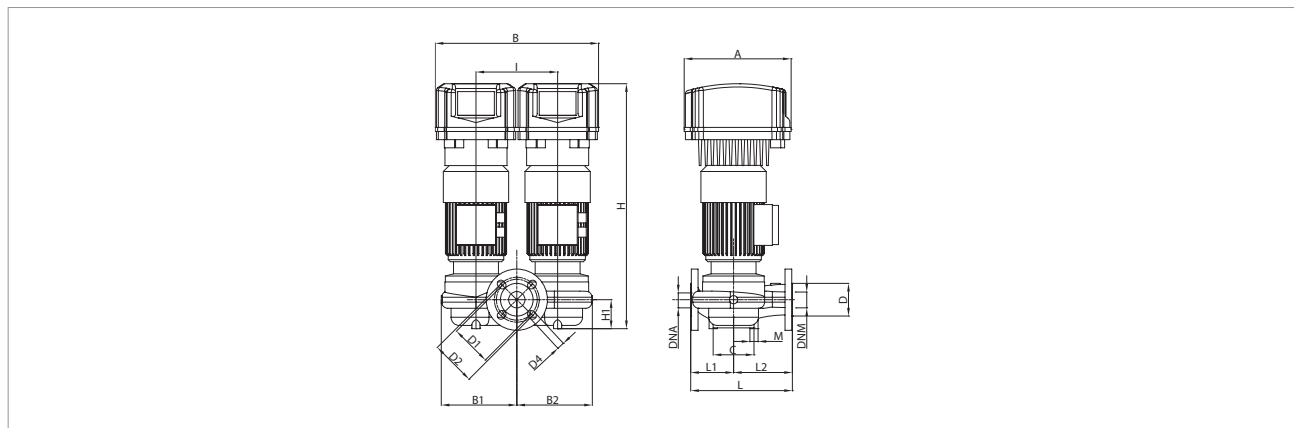

MODEL	ELECTRICAL DATA						
	POWER INPUT 50-60 Hz	MOTOR TYPE	n.r.p.m.	P1 MAX W	P2 NOMINAL		In A
					kW	HP	
DKLPE 40- 600 M MCE11/C	1x220-240 V ~	2 poles	2950	0,37	0,37	0,50	4,3
DKLPE 40-1200 M MCE11/C *		2 poles	2890	0,63	0,55	0,75	6,0

* ΔP-v proportional differential pressure adjustment mode also available.

MODEL	A	B	B1	B2	C	D	D1	D2	D3	D4	H	H1	I	L	L1	L2	M	DNA GAS	DNM GAS	PACKING DIMENSIONS			VOLUME (m ³)	WEIGHT kg
																				L/A	L/B	H		
DKLPE 40- 600 M MCE11/C	262	400	185	187	100	80	100	110	150	4 HOLES	608	66	200	250	105	145	2 HOLES M14	40	40	500	270	660	0,09	56
DKLPE 40-1200 M CE11/C	262	400	185	187	100	80	100	110	150	18x23	608	66	200	250	105	145		40	40	500	270	660	0,09	61

DKLME / DKLPE 50 - IN-LINE ELECTRIC PUMPS FOR HEATING, AIR CONDITIONING, REFRIGERATION, SOLAR, AND SANITARY SYSTEMS - TWIN, FLANGED, WITH MCE/C INVERTER

Pumped liquid temperature range: from -15 °C to +120 °C - Maximum ambient temperature: +40°C

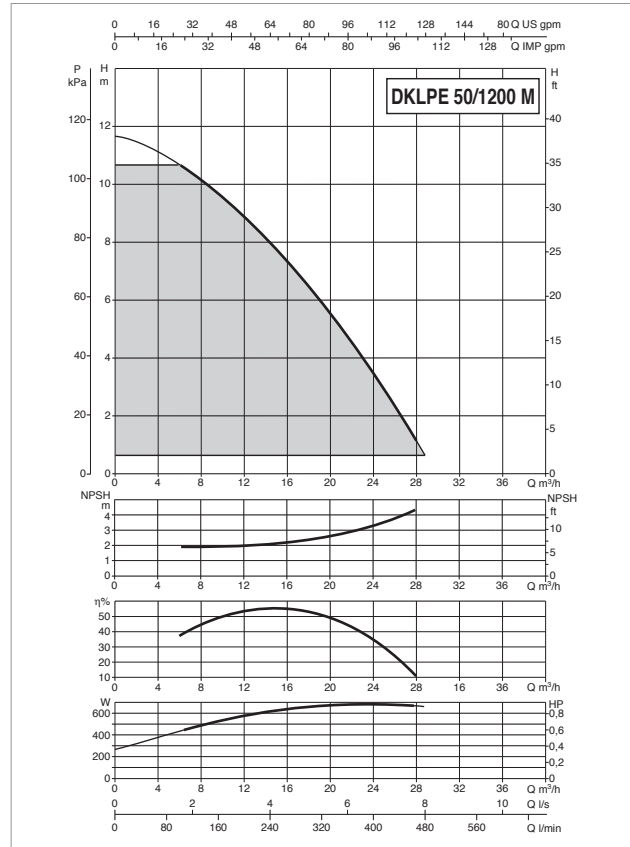
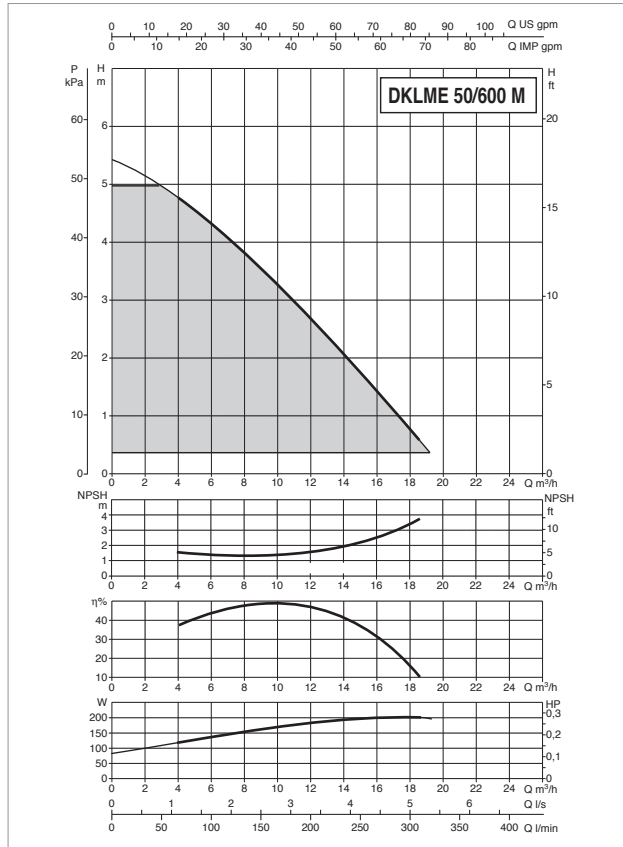

For the MEI index refer to the hydraulic data of the individual pump.

The performance curves are based on kinematic viscosity values = 1 mm²/s and density equal to 1000 kg/m³. Curve tolerance according to ISO 9906.

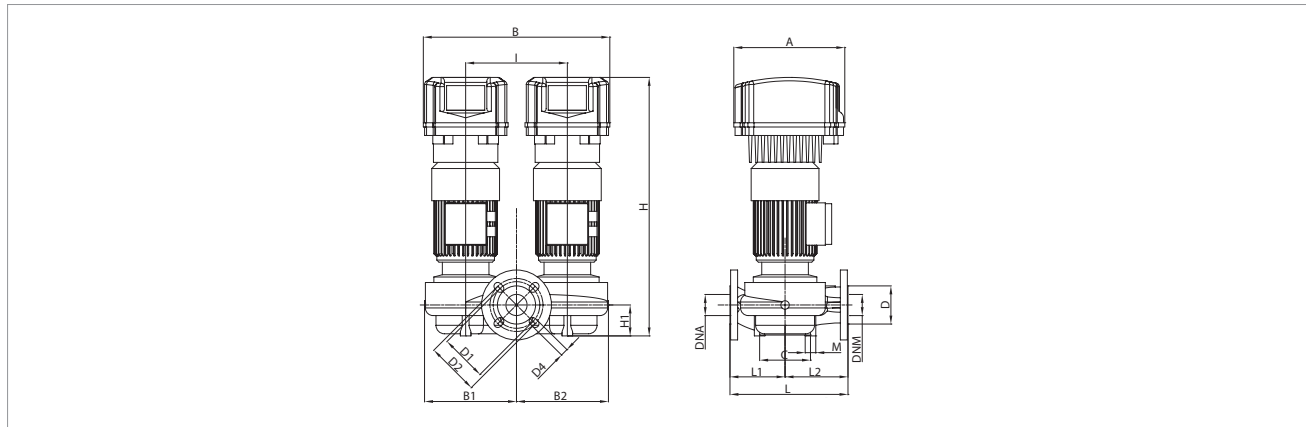

MODEL	ELECTRICAL DATA						
	POWER INPUT 50-60 Hz	MOTOR TYPE	n.r.p.m.	P1 MAX W	P2 NOMINAL		In A
					kW	HP	
DKLME 50-600 M MCE11/C	1x220-240 V ~	4 poles	1340	0,34	0,25	0,33	4,1
DKLPE 50-1200 M MCE11/C *		2 poles	2890	0,90	0,75	1,00	7,7

* ΔP-v proportional differential pressure adjustment mode also available.

MODEL	A	B	B1	B2	C	D	D1	D2	D3	D4	H	H1	I	L	L1	L2	M	DNA GAS	DNM GAS	PACKING DIMENSIONS			VOLUME (m³)	WEIGHT kg
																				L/A	L/B	H		
DKLME 50-600 M MCE11/C	262	400	217	217	120	90	110	125	165	4 HOLES	622	73	200	280	130	150	2	50	50	520	400	710	0,15	76
DKLPE 50-1200 M CE11/C	262	400	217	217	120	90	110	125	165	18x23 HOLES	622	73	200	280	130	150	M14	50	50	520	400	710	0,15	88

DKLME / DKLPE 65 - IN-LINE ELECTRIC PUMPS FOR HEATING, AIR CONDITIONING, REFRIGERATION, SOLAR, AND SANITARY SYSTEMS - TWIN, FLANGED, WITH MCE/C INVERTER

Pumped liquid temperature range: from -15 °C to +120 °C - Maximum ambient temperature: +40°C

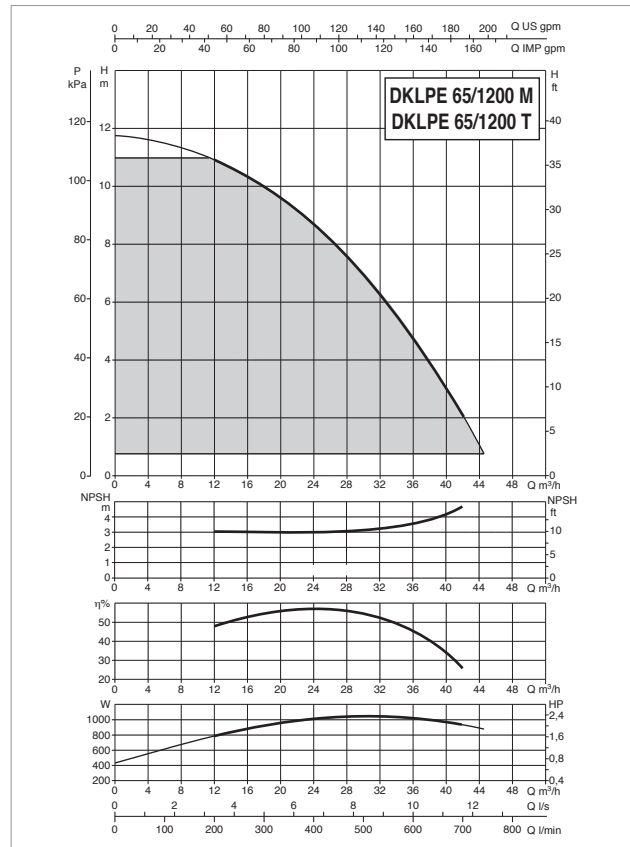
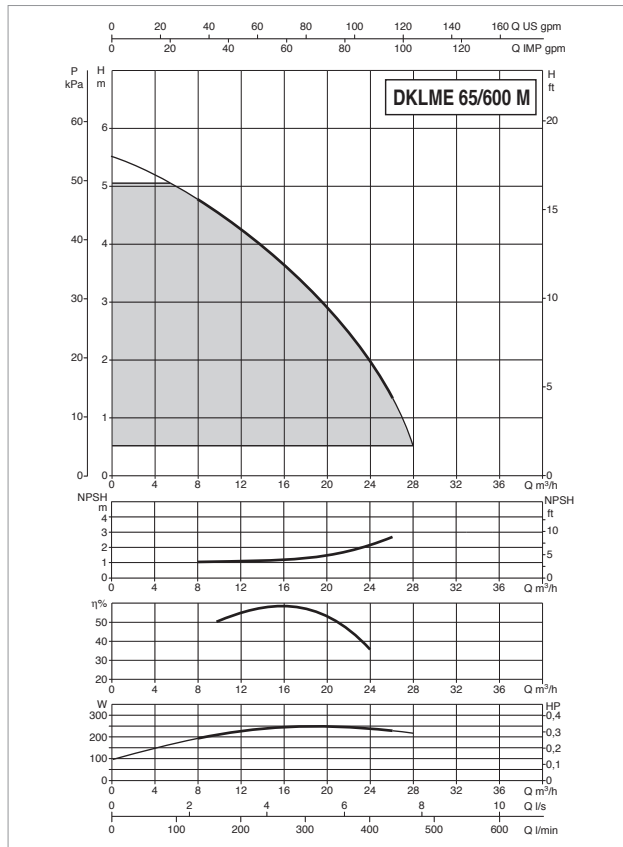

For the MEI index refer to the hydraulic data of the individual pump.

The performance curves are based on kinematic viscosity values = 1 mm²/s and density equal to 1000 kg/m³. Curve tolerance according to ISO 9906.

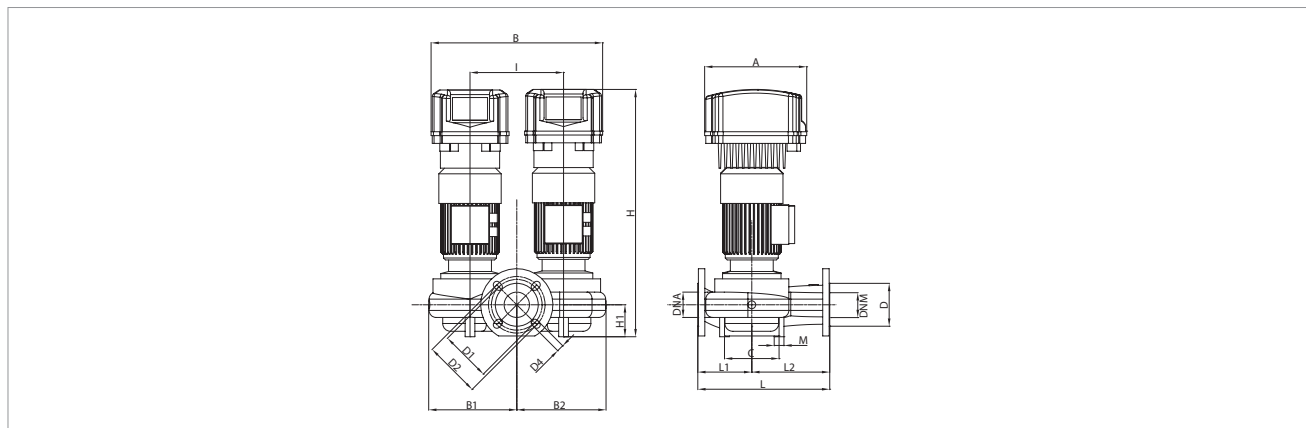

MODEL	ELECTRICAL DATA						
	POWER INPUT 50-60 Hz	MOTOR TYPE	n.r.p.m.	P1 MAX W	P2 NOMINAL		In A
					kW	HP	
DKLME 65-600 M MCE11/C	1x220-240 V ~	4 poles	1400	0,38	0,37	0,50	4,3
DKLPE 65-1200 M MCE11/C *		2 poles	2880	1,37	1,10	1,50	10,7
DKLPE 65-1200 T MCE30/C *		2 poles	2880	1,37	1,10	1,50	3,9

* ΔP-v proportional differential pressure adjustment mode also available.

MODEL	A	B	B1	B2	C	D	D1	D2	D3	D4	H	H1	I	L	L1	L2	M	DNA GAS	DNM GAS	PACKING DIMENSIONS			VOLUME (m ³)	WEIGHT kg
																				L/A	L/B	H		
DKLME 65-600 M MCE11/C	262	440	226	229	140	110	130	145	185	4 HOLES 18x23	641	82	240	340	140	200	2 HOLES M14	65	65	520	400	710	0,15	80
DKLPE 65-1200 M CE11/C	262	440	226	229	140	110	130	145	185		641	82	240	340	140	200		65	65	520	400	710	0,15	99
DKLPE 65-1200 T MCE30/C	353	537	226	229	140	110	130	145	185	639	82	240	340	140	200	65	65	726	626	844	0,38	92,3		

DKLME / DKLPE 80 - IN-LINE ELECTRIC PUMPS FOR HEATING, AIR CONDITIONING, REFRIGERATION, SOLAR, AND SANITARY SYSTEMS - TWIN, FLANGED, WITH MCE/C INVERTER

Pumped liquid temperature range: from -15 °C to +120 °C - Maximum ambient temperature: +40°C

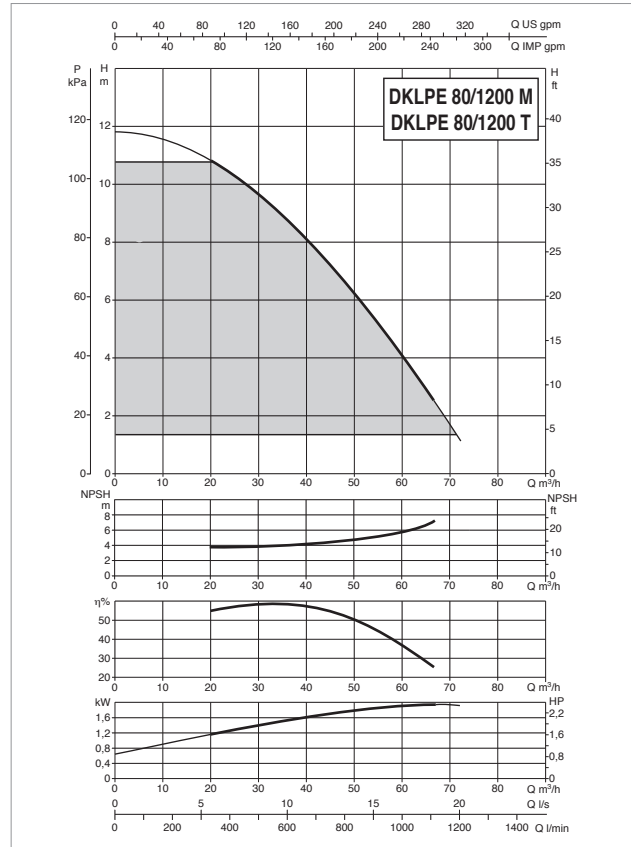
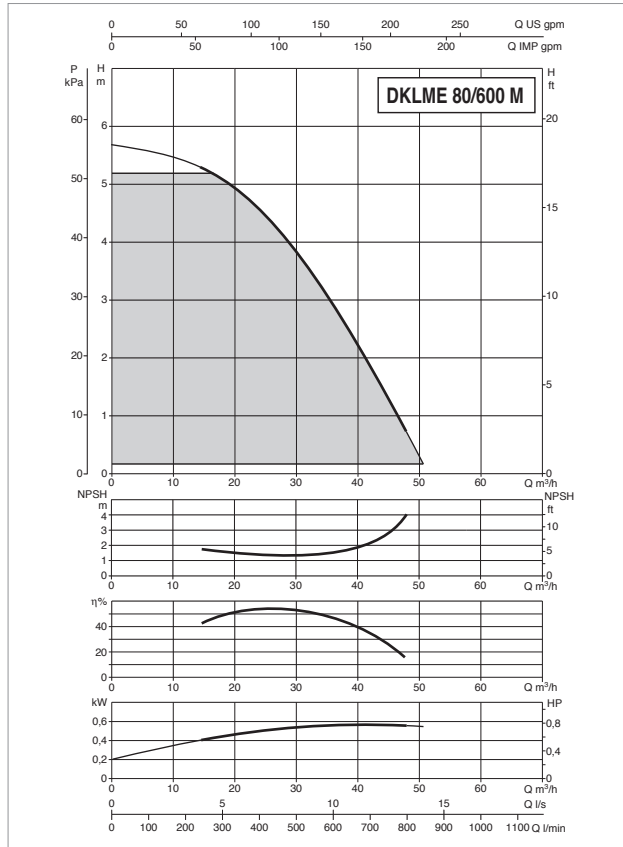

For the MEI index refer to the hydraulic data of the individual pump.

The performance curves are based on kinematic viscosity values = 1 mm²/s and density equal to 1000 kg/m³. Curve tolerance according to ISO 9906.

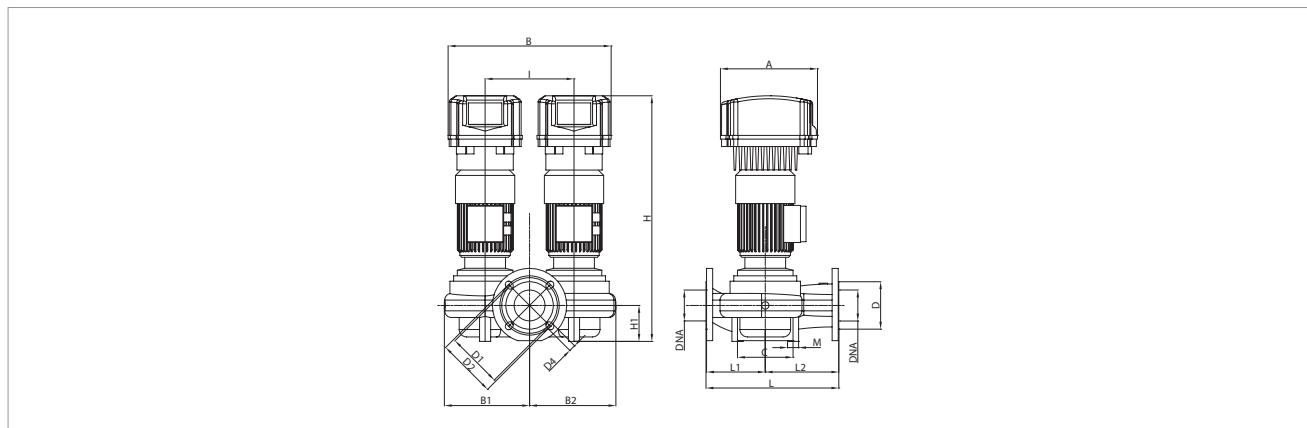

MODEL	ELECTRICAL DATA						
	POWER INPUT 50-60 Hz	MOTOR TYPE	n.r.p.m.	P1 MAX W	P2 NOMINAL		In A
					kW	HP	
DKLME 80-600 M MCE11/C *	1x220-240 V ~	4 poles	1440	0,79	0,75	1,00	7,0
DKLPE 80-1200 M MCE22/C *		2 poles	2840	2,21	1,84	2,50	16,0
DKLPE 80-1200 T MCE30/C *		2 poles	2840	2,21	1,84	2,50	4,8

* ΔP-v proportional differential pressure adjustment mode also available.

MODEL	A	B	B1	B2	C	D	D1	D2	D3	D4	H	H1	I	L	L1	L2	M	DNA GAS	DNM GAS	PACKING DIMENSIONS			VOLUME (m ³)	WEIGHT kg
																				L/A	L/B	H		
DKLME 80-600 M MCE11/C	262	440	230	233	150	128	150	160	200	4 HOLES 18x23	671	97	240	360	160	200	2 HOLES M14	80	80	520	400	710	0,15	96
DKLPE 80-1200 M CE22/C	262	440	230	233	150	128	150	160	200		746	97	240	360	160	200		80	80	520	400	710	0,15	98
DKLPE 80-1200 T MCE30/C	353	537	230	233	150	128	150	160	200		743	97	240	360	160	200		80	80	726	626	844	0,28	108,1