

EL 160 Eco & EL 500 Eco

– Our new generation of electric boilers with touchscreen

The Professional's Choice Since 1935

Installation and Operating Instructions



IMPORTANT

READ CAREFULLY BEFORE USE
SAVE FOR FUTURE REFERENCE

1700 891 12-4 EN 24/09/2020

Table of Contents

Important to keep in mind!	6	10. Detailed menu descriptions	35
Safety Instructions	6	10.1 Home screen	35
Recycling	6	10.2 Description of icons	35
1. Installation	7	10.3 Main menu	36
1.1 Installation – HVAC	7	10.4 Alarm menu	36
1.1.1 Water Quality / Boiler Water	7	10.4.1 Alarm description	36
1.1.2 Glycol in boiler water	7	10.4.2 Operational information	37
1.1.3 Built-in safety system (factory-fitted)	7	10.4.3 Saved operational info	37
1.2 Installation – Electrical	8	10.5 Advanced	37
1.2.1 Re-tightening the power cable connections	8	10.6 Settings	38
1.3 Installation – Ventilation	8	10.7 Quick start	38
1.4 Installation with external control (eg heat pump)	8	10.8 Time & Language	38
		10.8.1 Define system	39
		10.8.2 Service	39
2. Commissioning	8	10.9 Write log to USB	40
3. Overheating protection	9	10.10 Function Test	40
3.1 Overheating protection (Thermal cut-off)	9	10.10.1 Update SW from USB	41
3.2 Circuit breaker (72-504 kW)	9	10.10.2 Backup/reset settings from USB	41
		10.10.3 Reset highest boiler temperature	41
		10.10.4 Reset operating time calc.	41
		10.10.5 Reset energy calculator	41
		10.10.6 Reset history	41
		10.10.7 Service timer	41
		10.10.8 BMS Building Management automation	42
		10.10.9 BMS variables	42
4. Servicing	10	10.11 Outdoor Compensation – UTK	43
4.1 Re-tightening the power cable connections	10	10.11.1 Heating curve ascension/inclination	44
4.1.1 Re-tightening performed	10	10.11.2 Heating curve adjustment	44
4.2 Replacing the air filter	10	10.11.3 Highest primary boiler temperature	44
4.3 Safety valve function test	10	10.11.4 Lowest primary boiler temperature	44
4.4 Settings circuit breaker	11	10.11.5 Reduced boiler temperature	44
4.5 Instructional images for re-tightening	12	10.11.6 Diagram boiler temperature	45
		10.12 Stage regulator	45
5. Technical Data	14	10.13 Delta T, deadband	45
5.1 Technical data EL 160 Eco, 72-156 kW	14	10.14 Deadband range	45
5.1.1 Design data – EL 160 Eco	14	10.15 Current overload	46
5.1.2 Pressure drop / Water resistance EL 160 Eco	14	10.16 Output control	46
5.1.3 Dimensions & Connections EL 160 Eco S	15	10.17 Current limitation	46
5.1.4 Power steps EL 160 Eco	16	10.18 Current sensors	46
5.2 Technical data EL 500 Eco	18	10.19 Alarm messages	47
5.2.1 Design data – EL 500 Eco	18	10.20 External power	47
5.2.2 Pressure drop / Water resistance EL 500 Eco	18		
5.2.3 Dimensions & Connections EL 500 Eco S	19	11. Sensor resistances	48
5.2.4 Power steps EL 500 Eco	20	12. Spare parts Eco series	49
5.2.5 Example of power limitation	24	13. CE certificate	50
		14. Appendices	52
6. Built-in Safety System	25		
6.1 Design	25		
6.2 General	26		
6.3 Safety valve ¹	26		
6.4 Pressure transmitter ²	26		
6.5 Overheating protection (max. thermostat) ³	26		
7. Accessories	27		
8. Control system	28		
8.1 Factory-set values	28		
9. Menu overview	29		

Congratulations to your new electric boiler!

You have just purchased an Osby Parca electric boiler which we hope you will be completely satisfied with. On the following pages, you can read about how to take care of your electric boiler.

Save this user manual with installation and care instructions. Your Osby Parca electric boiler will bring you joy for many years, and all the information and initial assistance you need can be found herein.

To ensure a long and fulfilling relationship with your electric boiler, you should sign a servicing contract with your installer.

This will enable the electric boiler to function in good condition for a long time. It will then produce the heat you need – at the lowest total cost – for many years to come.

Contact info service department:

Enertech AB, Osby Parca div
Tel no +46 (0)479 177 28 | service@osbyparca.se
www.osbyparca.se
Box 93 | 283 22 Osby
SWEDEN

Note: Fill in the information below. This information is valuable if servicing is required.	
Product no 1:	Manufacturer no.:
Product no 2:	Manufacturer no.:
Installation company:	Tel. no.:
Installation date:	Name:
Electrical contractor:	Tel. no.:
Date:	Name:



If these instructions are not followed during installation, operation and maintenance, Enertech's obligation pertaining to the applicable warranty terms and conditions is not binding.

Important to keep in mind!

- Care of the boiler must be done according to the instructions.
- Any inspection of the boiler must be carried out by certified technicians who are trained to work with boilers, associated equipment and accessories.
- Prior to any inspection activities being carried out, this user manual and other associated manuals and documents applicable to the equipment must be read in full and understood.

It is of particular importance that the following points are adhered to upon delivery and installation:

- The product must be transported and stored in an upright position. When being moved, the product can be placed flat for a short time only.
- Remove the packaging and, prior to installation, make sure the product has not been damaged during transport. Report any shipping damage to the transporter.
- Place the product on a stable surface, preferably concrete.
If the product is to stand on a soft surface, support slabs must be placed under the feet.
- Remember that a servicing access area of at least 1.2 metres in front of the product is required.
- The product must not be sunk below floor level.

Safety Instructions

The following safety instructions must be taken into account when handling, installing and using the product:

- Turn off the safety switch and all circuit breakers before performing any work on the product. Please note that the boiler requires both 400 V supply along with 230 V supply for the control system.
- The product may not be rinsed with water.
- When handling the product with lifting eyes or similar, make sure that the lifting devices, eye bolts and other parts are intact. Never stand or walk underneath a raised product.
- Never compromise safety by detaching or unscrewing covers, hoods or other parts.
- Never compromise safety by disconnecting safety equipment.
- Any work in the product's electrical system may only be carried out by a certified electrician.

Checking the safety valve:

- The safety valve for the boiler/system must be checked regularly. See chapter 4, Servicing.

This device is not designed to be used by persons (including children) with reduced physical, sensory or mental abilities, or persons with a lack of experience and knowledge who have not received guidance or instruction on the use of the device by a person responsible for their safety. Children must be supervised to ensure they do not play with the device.

Recycling

- The packaging must be deposited at a recycling station or with the installation engineer for correct waste management.
- At the end of the product's life cycle, it must be recycled in a correct way and be transported to a waste station or reseller offering a service of that type. Disposing of the product as household waste is not permitted.
- It is of great importance that the product's electrical/electronic equipment is properly disposed of.

1. Installation

1.1 Installation – HVAC

The boiler must be installed in accordance with current national regulations, as well as DHW system requirements. In addition, the boiler is approved for zero flow but is designed for pump circulation.

To facilitate servicing, pipes and cabling must not be placed over the boiler or attached to the boiler's rear top cover. The distance between the boiler top and the ceiling should not be less than 900 mm.

The Swedish Electrical Safety Board recommends that an area of 1200 mm in front of the boiler be kept free.

1.1.1 Water Quality / Boiler Water

The following requirements apply:

- Boiler water must not contain salt and lime concentrations at levels that may damage the boiler and increase the risk of limescale build-up.
- Water hardness must not exceed 10 dH.
- The pH-value of the water must not be too low (min. 7).
- The water must not contain sludge or any other contaminants.
- Requirements regarding water quality must always be met. Good water increases the service life of the boiler.

1.1.2 Glycol in boiler water

It's not uncommon to want to mix glycol into the boiler water.

However, the addition of glycol reduces the heat capacity of the water, i.e. to gain full output the flow must be increased.

There are different types of glycol but, as a rule of thumb, the following changes will occur:

- A 25 % glycol mixture reduces output by approx. 10 %.
- A 35 % glycol mixture reduces output by approx. 15 %.
- A 50 % glycol mixture reduces output by approx. 30 %.

The values above should be considered as guidelines and should not be taken at face value.

1.1.3 Built-in safety system (factory-fitted)

See chapter 6.

If the boiler to be installed has a built-in safety system, recommendations regarding the safety valve's outlet flow must be followed. The outlet flow from the safety valve should have a pressure drop of less than 10 % of the opening pressure, and should discharge safely.

Pressure transmitter factory settings:

- The minimum pressure is set to 0.25 bar
- The maximum pressure is set to 2.85 bar for boilers with 3 bar safety valve
- The maximum pressure is set to 5.85 bar for boilers with 6 bar safety valve

These settings must be checked by the installer and can be adjusted to suit the installation.

Note: At the standard boiler, the pressure switch connection is plugged. Nothing may be mounted there! Safety equipment must be mounted externally. The electric boiler is CE-approved as a unit and must not be altered.

1.2 Installation – Electrical

Electrical installation must be carried out by a certified electrician, and must be performed in accordance with valid regulations.

Connect 230 and 400 V according to the electrical circuit diagram. The control circuit (230V) must be preceded by a maximum of 16 A fuse.

Cableways or cables should not be placed over or attached to the boiler's rear roof panel.

Power switch is supplied with factory setting. Its response time should be adjusted after installed current for optimal release time.

1.2.1 Re-tightening the power cable connections

! When the boiler is put into operation, inspection and re-tightening of the power cable connections must be carried out for the immersion heaters (on the top of the boiler), current strips and their bolted joints, contactors, incoming phases - zero - earth, and other electrical connections. See chapter Servicing and "Instruction for Re-tightening".

! Inspection and re-tightening must then be carried out after 100 hours of operation, after 1 year and, thereafter, at intervals of no more than 2 years. A signature is required in the table on page 10 to support any eventual warranty claim.

Work in the boiler's electrical system may only be performed by a certified electrician.

NOTE! The boiler's electrics must not be put into operation until the water system is full and the boiler has been bled.

1.3 Installation – Ventilation

The electric boiler must be placed in an area supplied with fresh air intake and of sufficient space, where the ambient temperature does not exceed 25 °C and does not fall below 0 °C.

Requirements regarding ambient temperature must be strictly adhered to, as these are functional prerequisites for the electric boiler's internal ventilation/cooling.

1.4 Installation with external control (eg heat pump)

If the electric boiler is to be controlled by an external unit, connection must be done according to the electrical diagram. The control system defines how to control the boiler, external control, external control input. See chapter 8-10!

2. Commissioning

- Before commissioning, the entire manual must be read and understood.
- Make sure that the installation of water, electricity and ventilation is done according to chapter 1 and that there's water in the system.
- Start the boiler. The program should now start automatically according to the factory default settings (without external control).
- Any external control is set according to section 10.8.1 and the manual for external control, e.g. a heat pump.

3. Overheating protection

3.1 Overheating protection (Thermal cut-off)

The boiler is equipped with a thermal cut-off (Max. thermostat - Tz), which has been set to $105^{\circ}\pm 5^{\circ}$ C. This will interrupt the control circuit voltage to the boiler's contactors and release the circuit breakers. The max. thermostat is reset at about 70° C. Before the boiler has cooled down, it is not possible to reset the circuit breaker and acknowledge the alarm on the display.

To restart the boiler, the circuit breakers inside the boiler must be reset and the alarm on the display acknowledged.

3.2 Circuit breaker (72-504 kW)

The circuit breaker cannot be switched on until the triggered safeguard is reset.

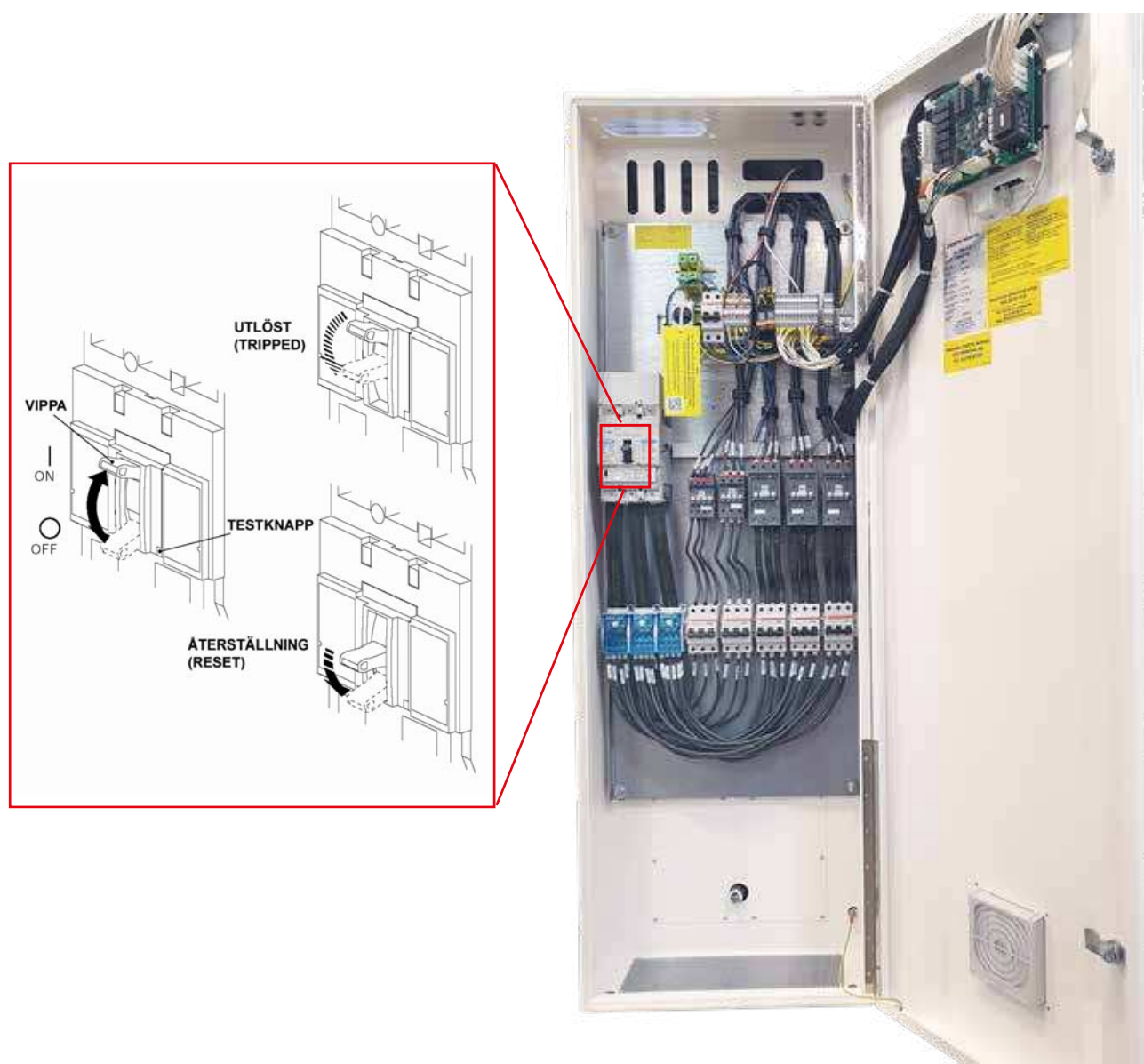

4. Servicing

The boiler's control system assists by keeping track of when servicing needs to be carried out. This can be set with the touchscreen in the Service menu. Error messages are also displayed here, along with suggestions for how to rectify the error.

After remedial action, the boiler technician/service technician uses the boiler's 4-digit PIN code to perform a reset. The code is issued once the warranty document has been registered.

4.1 Re-tightening the power cable connections

Inspection and re-tightening must be carried out after 100 hours of operation, after 1 year and, thereafter, at intervals of no more than 2 years. A signature is required in the table below to support any eventual warranty claim. The control system's service timer assists with keeping track of servicing intervals (provided the correct values have been set). Work in the boiler's electrical system may only be performed by a certified electrician.

See the torque image at page 12-13. Sign the table!

4.1.1 Re-tightening performed

Company	Date	Signature

4.2 Replacing the air filter

For EL 160 Eco and 500 Eco, the air filter must be replaced once per year. This may need to be done more frequently depending on the boiler room environment. The filter is replaced from the outside.

The article number can be found under the Spare Parts chapter in this manual.

4.3 Safety valve function test

For safe operation and functionality, a function test should be carried out at least once per year. Turn the plastic cap (pressure relief valve) until the valve opens. The seal wire is usually of the correct length and does not need to be cut.

4.4 Settings circuit breaker

Please fill in the table at installation and when the boiler is current limited, see magnification of image on p.12!

NOTE! Applies to both models even if only shown in the "Instructions for re-tightening" for EL 160 Eco.

Date	Set value I_R (A)	Signature

Charateristics: recommended set value is **1** = releases already at low overload.

I_R : Setting depends on power supply.

Ex: Set value $I_R = 0,4$ when current = 100 A

0,5 - " - 125 A

0,8 - " - 200 A

0,9 - " - 225 A

1 - " - 250 A

4.5 Instructional images for re-tightening

Instructions for re-tightening Osby Parca EL 160 Eco

NOTE! Important!

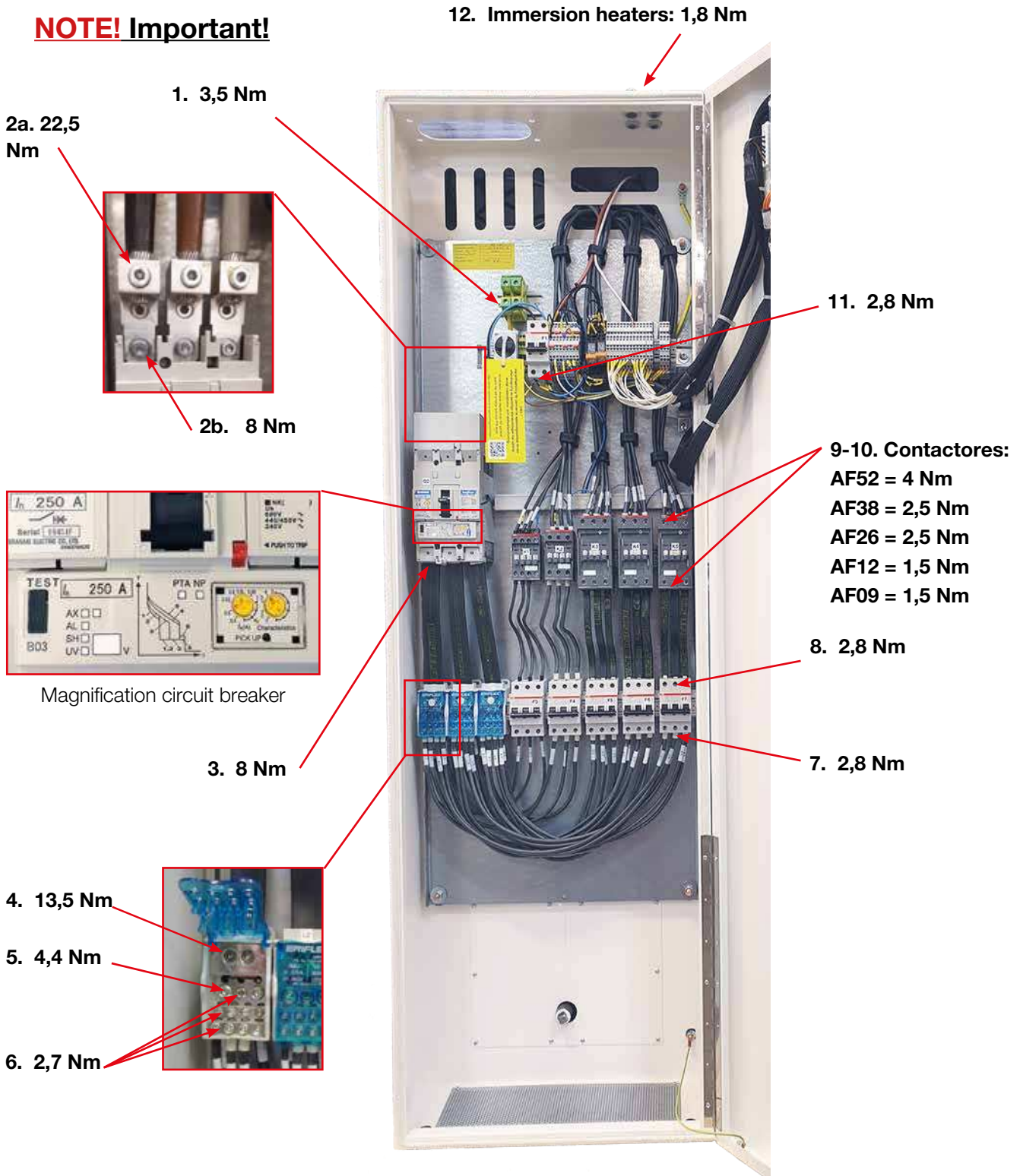

Instructions for re-tightening Osby Parca EL 500 Eco

NOTE! Important!

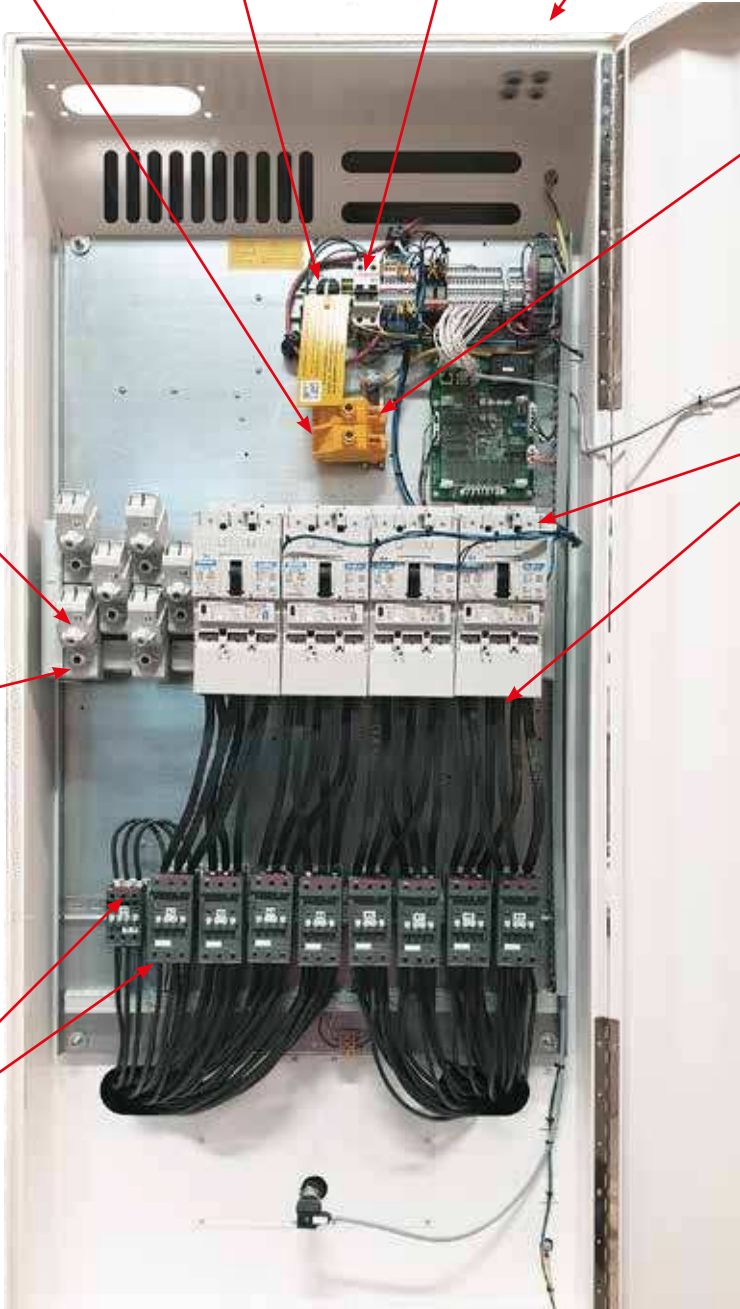
- 
1. 50-95 mm² = 20 Nm
120-300 mm² = 45 Nm
 2. 0,8 Nm
 3. 2,8 Nm
 4. Immersion heaters: 1,8 Nm
 5. Against rail:
20 Nm
 6. 8 Nm
 - 7-8. Contactores:
AF52 = 4 Nm
AF65 = 4 Nm
 9. 15 Nm
 10. 26-30 Nm

5. Technical Data

5.1 Technical data EL 160 Eco, 72-156 kW

Art. No.		Output		1:st Step	Steps	Voltage	Current	Weight (excl. water)
	Std	S	kW	kW	Qty	V	A	kg
7700130	-01	-31	72	9	7	400 V	104	170-175
7700130	-02	-32	93	9	9	400 V	134	170-175
7700130	-03	-33	114	9	11	400 V	164	180-185
7700130	-04	-34	135	9	13	400 V	195	180-185
7700130	-05	-35	156	9	15	400 V	225	180-185

5.1.1 Design data – EL 160 Eco

Design pressure	4.0 bar
Testing pressure	5.7 bar
Design temperature	110 °C
Maximum operating temperature	100 °C
Boiler water volume	110 litres
Protection class	IP21
Cable connection	2 x 120 mm ²
Max.thermostat	105 +/- 5 °C
Max preceded fuse for control circuit (230 V)	16 A

5.1.2 Pressure drop / Water resistance EL 160 Eco

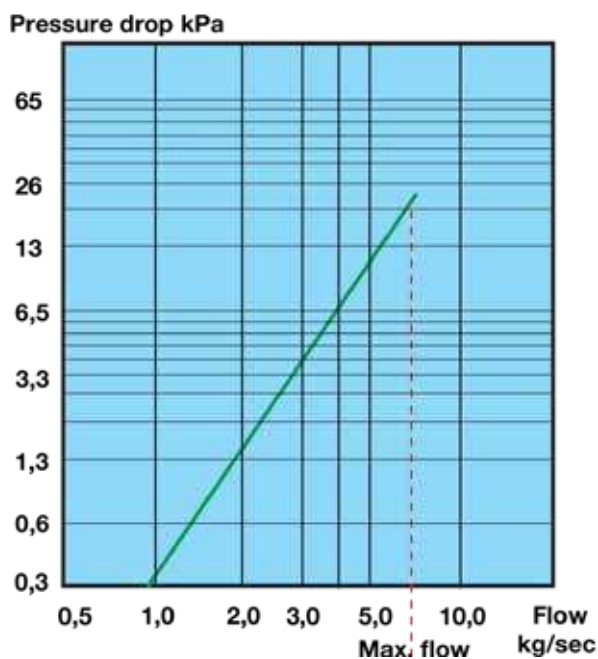

5.1.3 Dimensions & Connections EL 160 Eco S (safety valve being discontinued on std versions)

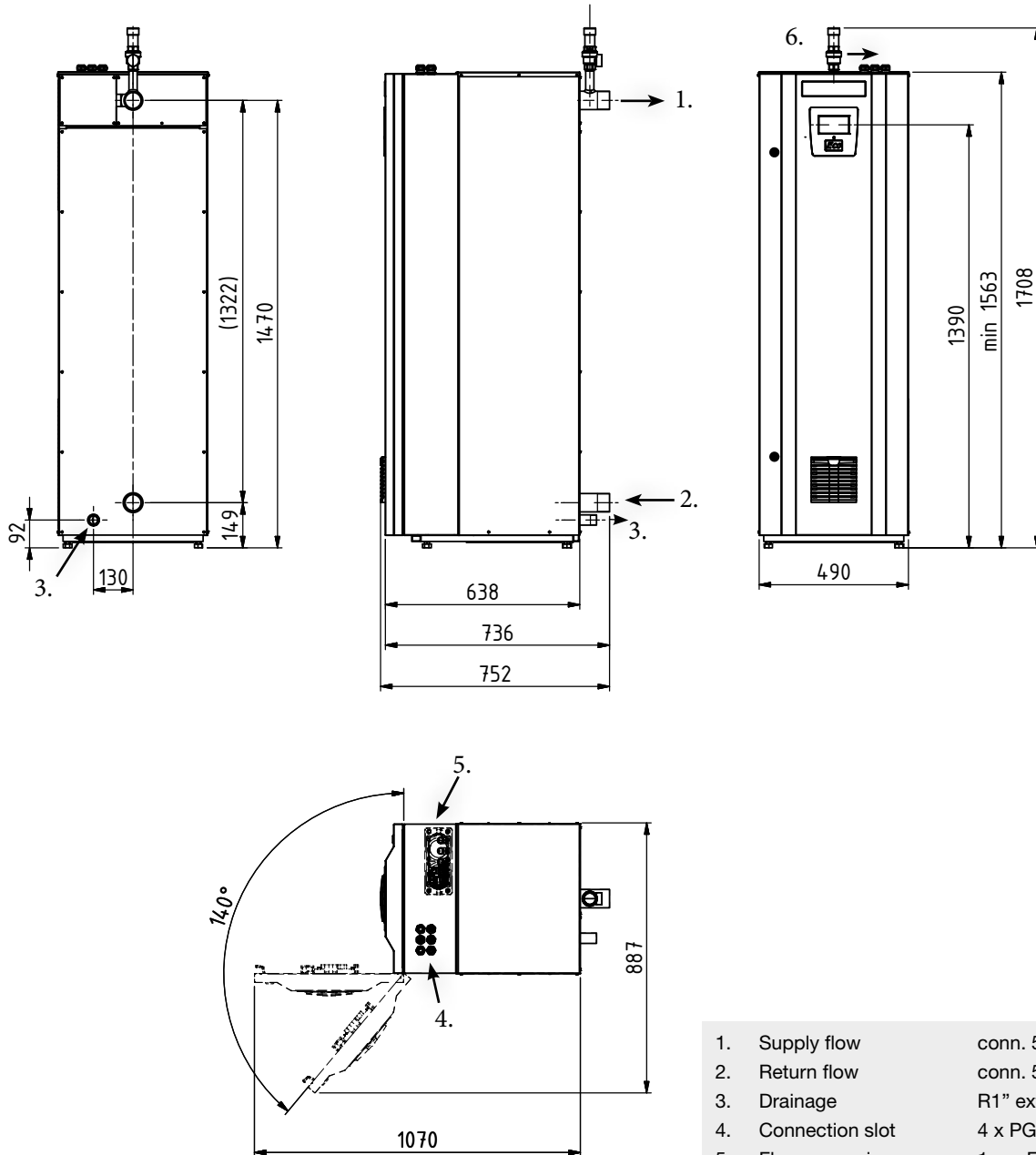

- | | |
|-----------------------|------------------------|
| 1. Supply flow | conn. 50 (ext. thread) |
| 2. Return flow | conn. 50 (ext. thread) |
| 3. Drainage | R1" ext. |
| 4. Connection slot | 4 x PG11 |
| 5. Flange opening | 1 pc. FL-21 |
| 6. Safety valve 3 bar | DN 20/25 (Only in S) |

Minimum distance of 900 mm between boiler top and inner ceiling.

Separate power supply 230 V 1 ~ required for operating voltage.

Pipe connection has dimensions and C-C equal to Osby Parca EL 150.

To facilitate immersion heater replacement, pipes and cabling must not be placed over the boiler or attached to the boiler's rear top cover. The distance between the boiler top and the ceiling should not be less than 900 mm.

5.1.4 Power steps EL 160 Eco

7700130-01/31

EL 160 Eco 72 kW

400 V 3-phase

Step	%	Kw	Kw					CURRENT
			9	21	21	21		
			R 1	R 2	R 3	R 4	R 5	
			K1	K2	K3	K4		A
1	13%	9	1	0	0	0		13
2	29%	21	0	1	0	0		30
3	42%	30	1	1	0	0		43
4	58%	42	0	1	1	0		61
5	71%	51	1	1	1	0		74
6	88%	63	0	1	1	1		91
7	100%	72	1	1	1	1		104

7700130-02/32

EL 160 Eco 93 kW

400 V 3-phase

Step	%	Kw	Kw					CURRENT
			9	21	21	21	21	
			R 1	R 2	R 3	R 4	R 5	
			K1	K2	K3	K4	K5	A
1	10%	9	1	0	0	0	0	13
2	23%	21	0	1	0	0	0	30
3	32%	30	1	1	0	0	0	43
4	45%	42	0	1	1	0	0	61
5	55%	51	1	1	1	0	0	74
6	68%	63	0	1	1	1	0	91
7	77%	72	1	1	1	1	0	104
8	90%	84	0	1	1	1	1	121
9	100%	93	1	1	1	1	1	134

7700130-03/33

EL 160 Eco 114 kW

400 V 3-phase

Step	%	Kw	Kw					CURRENT
			9	21	21	21	42	
			R 1	R 2	R 3	R 4	R 5	
			K1	K2	K3	K4	K5	A
1	8%	9	1	0	0	0	0	13
2	18%	21	0	1	0	0	0	30
3	26%	30	1	1	0	0	0	43
4	37%	42	0	0	0	0	1	61
5	45%	51	1	0	0	0	1	74
6	55%	63	0	1	1	1	0	91
7	63%	72	1	1	1	1	0	104
8	74%	84	0	0	1	1	1	121
9	82%	93	1	0	1	1	1	134
10	92%	105	0	1	1	1	1	152
11	100%	114	1	1	1	1	1	165

7700130-04/34

EL 160 Eco 135 kW**400 V 3-phase**

Step	%	Kw	Kw					CURRENT A
			9	21	21	42	42	
			R 1 K1	R 2 K2	R 3 K3	R 4 K4	R 5 K5	
1	7%	9	1	0	0	0	0	13
2	16%	21	0	1	0	0	0	30
3	22%	30	1	1	0	0	0	43
4	31%	42	0	1	1	0	0	61
5	38%	51	1	1	1	0	0	74
6	47%	63	0	0	1	1	0	91
7	53%	72	1	0	1	1	0	104
8	62%	84	0	0	0	1	1	121
9	69%	93	1	0	0	1	1	134
10	78%	105	0	1	0	1	1	152
11	84%	114	1	1	0	1	1	165
12	93%	126	0	1	1	1	1	182
13	100%	135	1	1	1	1	1	195

7700130-05/35

EL 160 Eco 156 kW**400 V 3-phase**

Step	%	Kw	Kw					CURRENT A
			9	21	42	42	42	
			R 1 K1	R 2 K2	R 3 K3	R 4 K4	R 5 K5	
1	6%	9	1	0	0	0	0	13
2	13%	21	0	1	0	0	0	30
3	19%	30	1	1	0	0	0	43
4	27%	42	0	0	1	0	0	61
5	33%	51	1	0	1	0	0	74
6	40%	63	0	1	1	0	0	91
7	46%	72	1	1	1	0	0	104
8	54%	84	0	0	1	1	0	121
9	60%	93	1	0	1	1	0	134
10	67%	105	0	1	1	1	0	152
11	73%	114	1	1	1	1	0	165
12	81%	126	0	0	1	1	1	182
13	87%	135	1	0	1	1	1	195
14	94%	147	0	1	1	1	1	212
15	100%	156	1	1	1	1	1	225

5.2 Technical data EL 500 Eco

Art. No.		Output	First step	Step	Voltage	Current	Weight (excl.water)
	Std	S	kW	kW	Qty	V	kg
7700151	-01	-31	204	15	15	400 V	380
7700151	-02	-32	252	21	12	400 V	380
7700151	-03	-33	315	21	15	400 V	390
7700151	-04	-34	378	21	18	400 V	400
7700151	-05	-35	441	21	21	400 V	405
7700151	-06	-36	504	21	24	400 V	410

5.2.1 Design data - EL 500 Eco

Design pressure	6.0 bar
Testing pressure	8.6 bar
Design temperature	110 °C
Maximum operating temperature	100 °C
Boiler water volume	372 litres
Protection class	IP21
Cable connection	2 x 240 mm ²
Max.thermostat	105 +/- 5 °C
Max preceded fuse for control circuit (230 V)	16 A

5.2.2 Pressure drop / Water resistance EL 500 Eco

Pressure drop kPa

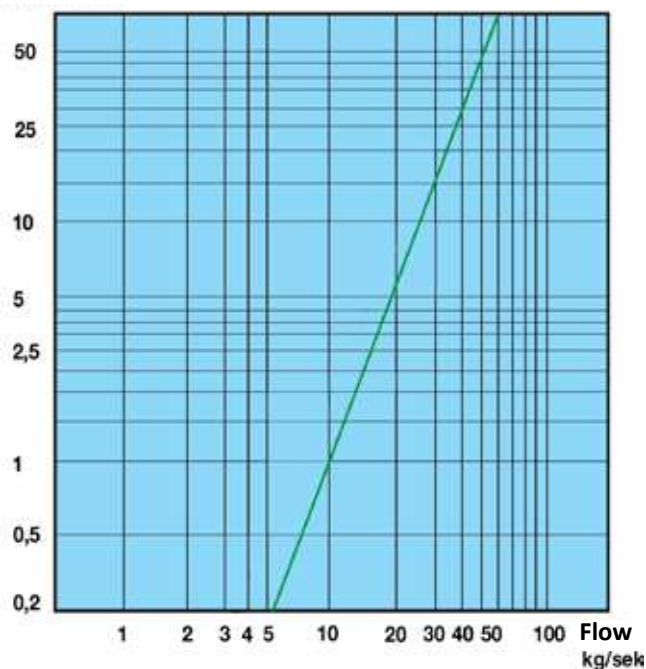

5.2.3 Dimensions & Connections EL 500 Eco S (safety valve being discontinued on std versions)

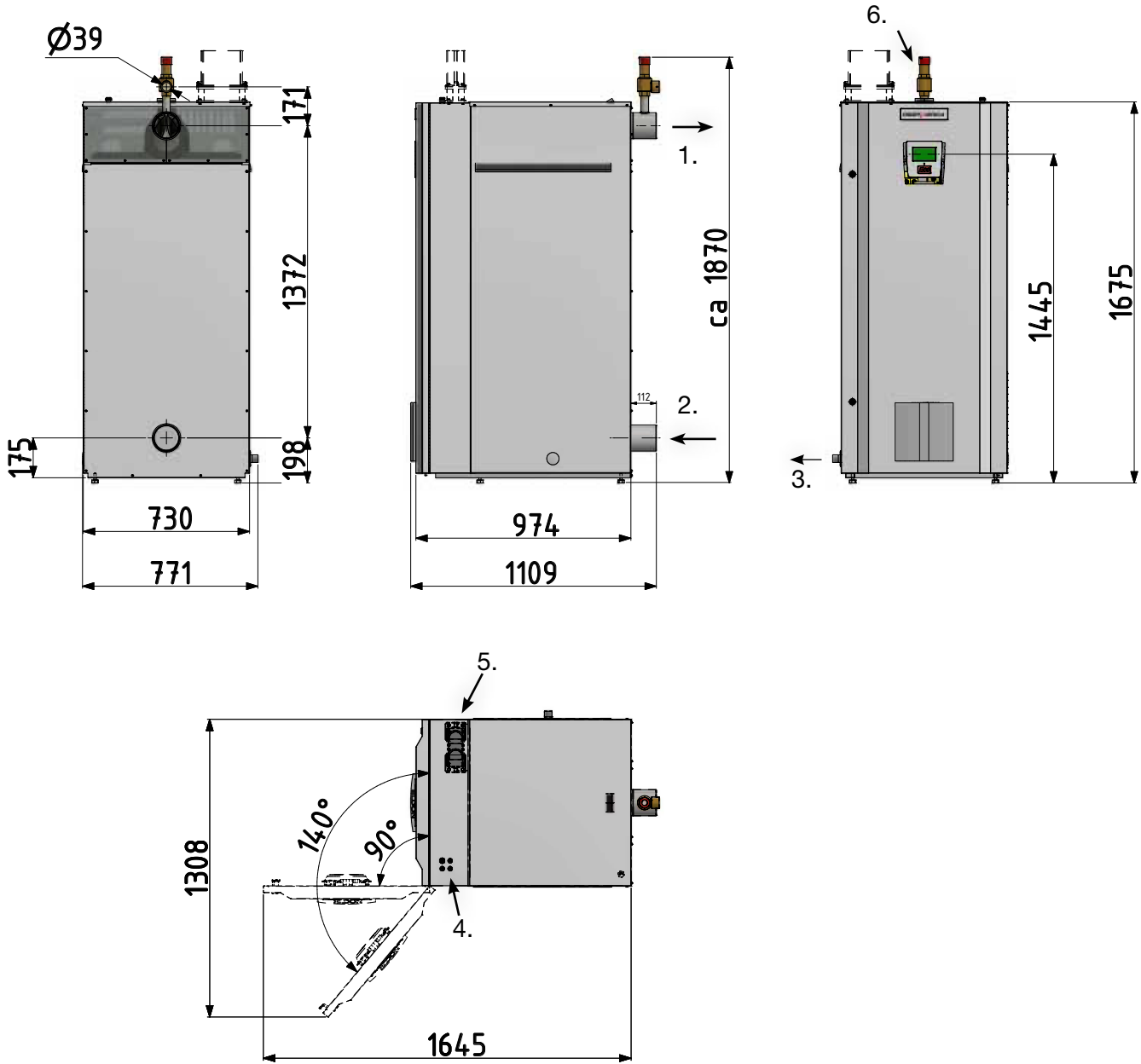

To facilitate immersion heater replacement, pipes and cabling must not be placed over the boiler or attached to the boiler's rear top cover. The distance between the boiler top and the ceiling should not be less than 900 mm.

- | | |
|-----------------------|----------------------|
| 1. Supply flow | DN100 (welding conn) |
| 2. Return flow | DN100 (welding conn) |
| 3. Drainage | R1" ext. |
| 4. Connection slot | 4 x PG11 |
| 5. Flange opening | 2 pc. FL-21 |
| 6. Safety valve 6 bar | DN 25/32 (Only in S) |

Minimum distance of 900 mm between boiler top and inner ceiling.
Separate power supply 230 V 1 ~ required for operating voltage.
Pipe connections do not have the same location as previous Parca EL 350/500.

5.2.4 Power steps EL 500 Eco

7700151-01, -31			EI 500 Eco 204 kW			400 V 3-phase	
		kW	21	42	63	63	63
			Relay 1	Relay 2	Relay 3	Relay 4	Relay 5
Step	%	kW	K1	K2	K3	K4	K5
1	7%	15	1	0	0	0	0
2	10%	21	0	1	0	0	0
3	18%	36	1	1	0	0	0
4	21%	42	0	0	1	0	0
5	28%	57	1	0	1	0	0
6	31%	63	0	1	1	0	0
7	38%	78	1	1	1	0	0
8	51%	105	0	0	1	1	0
9	59%	120	1	0	1	1	0
10	62%	126	0	1	1	1	0
11	69%	141	1	1	1	1	0
12	82%	168	0	0	1	1	1
13	90%	183	1	0	1	1	1
14	93%	189	0	1	1	1	1
15	100%	204	1	1	1	1	1

7700151-02, -32			EI 500 Eco 252 kW			400 V 3-phase	
		kW	21	42	63	63	63
			Relay 1	Relay 2	Relay 3	Relay 4	Relay 5
Steg	%	kW	K1	K2	K3	K4	K5
1	8%	21	1	0	0	0	0
2	17%	42	0	1	0	0	0
3	25%	63	0	0	1	0	0
4	33%	84	1	0	1	0	0
5	42%	105	0	1	1	0	0
6	50%	126	0	0	1	1	0
7	58%	147	1	0	1	1	0
8	67%	168	0	1	1	1	0
9	75%	189	0	0	1	1	1
10	83%	210	1	0	1	1	1
11	92%	231	0	1	1	1	1
12	100%	252	1	1	1	1	1

7700151-03, -33			EI 500 Eco 315 kW			400 V 3-phase		
		kW	21	42	63	63	63	63
			Relay 1	Relay 2	Relay 3	Relay 4	Relay 5	Relay 6
Step	%	kW	K1	K2	K3	K4	K5	K6
1	7%	21	1	0	0	0	0	0
2	13%	42	0	1	0	0	0	0
3	20%	63	0	0	1	0	0	0
4	27%	84	1	0	1	0	0	0
5	33%	105	0	1	1	0	0	0
6	40%	126	0	0	1	1	0	0
7	47%	147	1	0	1	1	0	0
8	53%	168	0	1	1	1	0	0
9	60%	189	0	0	1	1	1	0
10	67%	210	1	0	1	1	1	0
11	73%	231	0	1	1	1	1	0
12	80%	252	0	0	1	1	1	1
13	87%	273	1	0	1	1	1	1
14	93%	294	0	1	1	1	1	1
15	100%	315	1	1	1	1	1	1

7700151-04, -34			EI 500 Eco 378 kW			400 V 3-phase			
		kW	21	42	63	63	63	63	63
			Relay 1	Relay 2	Relay 3	Relay 4	Relay 5	Relay 6	Relay 7
Steg	%	kW	K1	K2	K3	K4	K5	K6	K7
1	6%	21	1	0	0	0	0	0	0
2	11%	42	0	1	0	0	0	0	0
3	17%	63	0	0	1	0	0	0	0
4	22%	84	1	0	1	0	0	0	0
5	28%	105	0	1	1	0	0	0	0
6	33%	126	0	0	1	1	0	0	0
7	39%	147	1	0	1	1	0	0	0
8	44%	168	0	1	1	1	0	0	0
9	50%	189	0	0	1	1	1	0	0
10	56%	210	1	0	1	1	1	0	0
11	61%	231	0	1	1	1	1	0	0
12	67%	252	0	0	1	1	1	1	0
13	72%	273	1	0	1	1	1	1	0
14	78%	294	0	1	1	1	1	1	0
15	83%	315	0	0	1	1	1	1	1
16	89%	336	1	0	1	1	1	1	1
17	94%	357	0	1	1	1	1	1	1
18	100%	378	1	1	1	1	1	1	1

7700151-05, -35			EI 500 Eco 441 kW			400 V 3-phase				
		kW	21	42	63	63	63	63	63	63
			Relay 1	Relay 2	Relay 3	Relay 4	Relay 5	Relay 6	Relay 7	Relay 8
Step	%	kW	K1	K2	K3	K4	K5	K6	K7	K8
1	5%	21	1	0	0	0	0	0	0	0
2	10%	42	0	1	0	0	0	0	0	0
3	14%	63	0	0	1	0	0	0	0	0
4	19%	84	1	0	1	0	0	0	0	0
5	24%	105	0	1	1	0	0	0	0	0
6	29%	126	0	0	1	1	0	0	0	0
7	33%	147	1	0	1	1	0	0	0	0
8	38%	168	0	1	1	1	0	0	0	0
9	43%	189	0	0	1	1	1	0	0	0
10	48%	210	1	0	1	1	1	0	0	0
11	52%	231	0	1	1	1	1	0	0	0
12	57%	252	0	0	1	1	1	1	0	0
13	62%	273	1	0	1	1	1	1	0	0
14	67%	294	0	1	1	1	1	1	0	0
15	71%	315	0	0	1	1	1	1	1	0
16	76%	336	1	0	1	1	1	1	1	0
17	81%	357	0	1	1	1	1	1	1	0
18	86%	378	0	0	1	1	1	1	1	1
19	90%	399	1	0	1	1	1	1	1	1
20	95%	420	0	1	1	1	1	1	1	1
21	100%	441	1	1	1	1	1	1	1	1

7700151-06, -36			EI 500 Eco 504 kW			400 V 3-phase					
		kW	21	42	63	63	63	63	63	63	63
			Relay 1	Relay 2	Relay 3	Relay 4	Relay 5	Relay 6	Relay 7	Relay 8	Relay 9
Step	%	kW	K1	K2	K3	K4	K5	K6	K7	K8	K9
1	4%	21	1	0	0	0	0	0	0	0	0
2	8%	42	0	1	0	0	0	0	0	0	0
3	13%	63	0	0	1	0	0	0	0	0	0
4	17%	84	1	0	1	0	0	0	0	0	0
5	21%	105	0	1	1	0	0	0	0	0	0
6	25%	126	0	0	1	1	0	0	0	0	0
7	29%	147	1	0	1	1	0	0	0	0	0
8	33%	168	0	1	1	1	0	0	0	0	0
9	38%	189	0	0	1	1	1	0	0	0	0
10	42%	210	1	0	1	1	1	0	0	0	0
11	46%	231	0	1	1	1	1	0	0	0	0
12	50%	252	0	0	1	1	1	1	0	0	0
13	54%	273	1	0	1	1	1	1	0	0	0
14	58%	294	0	1	1	1	1	1	0	0	0
15	63%	315	0	0	1	1	1	1	1	0	0
16	67%	336	1	0	1	1	1	1	1	0	0
17	71%	357	0	1	1	1	1	1	1	0	0
18	75%	378	0	0	1	1	1	1	1	1	0
19	79%	399	1	0	1	1	1	1	1	1	0
20	83%	420	0	1	1	1	1	1	1	1	0
21	88%	441	0	0	1	1	1	1	1	1	1
22	92%	462	1	0	1	1	1	1	1	1	1
23	96%	483	0	1	1	1	1	1	1	1	1
24	100%	504	1	1	1	1	1	1	1	1	1

5.2.5 Example of power limitation

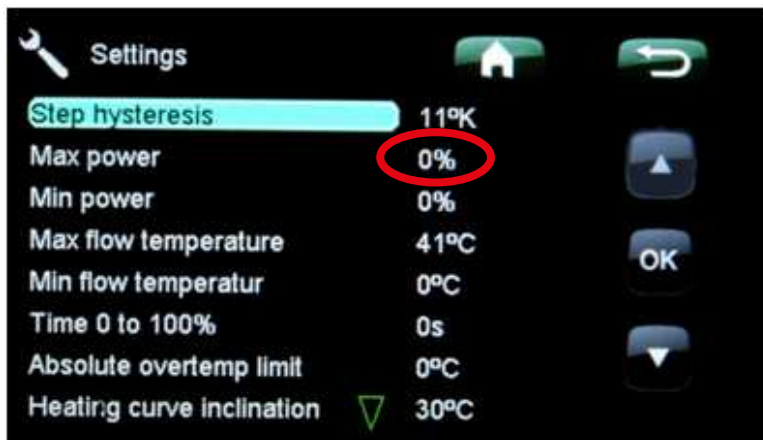

6. Built-in Safety System

Our built-in safety solution (69-498 kW) is approved for installation without catastrophe protection, steam collector, level sensor or flow monitor. This saves you both time and money.

Our solution consists of a safety valve, pressure transmitter and an overheating protection (max. thermostat). In addition, all models also have a power breaker.



Safety valve AT 8310A ¹



Pressure transmitter ²



Overheating protection/
Max. thermostat ³

We offer a convenient, simple and economical solution since all equipment comes fully assembled from our factory, which means you save time and money on installation and labour costs.

Equipment Built-in safety system				
Boiler output	Designation	Connection	Opening pressure	Quantity
72 - 156 kW	Safety valve ¹	DN 20/25	3 bar	1
	Pressure transmitter ²	DN 15		1
	Overheating protection/ Max. thermostat ³			1
204 - 504 kW	Safety valve ¹	DN 25/32	6 bar	1
	Pressure transmitter ²	DN 15		1
	Overheating protection/ Max. thermostat ³			1

6.1 Design

Design in accordance with this description as well as SS EN 12828 closed systems, AFS 2002:1 and AFS 2016:6.

6.2 General

Under normal operating conditions, all safety monitors have closed connections in the control circuit for the control equipment's outlet relays and the boiler's contactors. This applies for the ingoing safety valve, pressure transmitter and overheating protection (max. thermostat).

6.3 Safety valve ¹

The safety valve is fitted directly to the boiler and has sufficient capacity, as well as a pressure drop in the inlet which is less than 3 % of the opening pressure. The outlet flow from the safety valve must be checked during inspection to ensure that the pressure drop is less than 10 % of the opening pressure, and that it discharges safely.

For safe operation and functionality, a function test should be carried out at least once per year.

6.4 Pressure transmitter ²

If the boiler has a built-in safety system it is also equipped with a pressure transmitter with an outgoing signal of 4-20 mA and a relay controlling that the pressure is within stated range. (The protection closes a contact in the safety loop if the pressure is within valid range.) If the signal from the pressure transmitter shows to be outside valid range, the contact breaks the safety loop.

Actual pressure (for the boiler) can be read on the transmitter display inside the boiler.

If the range needs to be change, contact us and we will send you the manual for the transmitter.

At delivery these are the factory settings:

Min pressure is set on 0,25 bar.

Max. pressure is set on 2,85 bar for boilers with 3 bar safety valve

Max. pressure is set on 5,85 bar for boilers with 6 bar safety valve

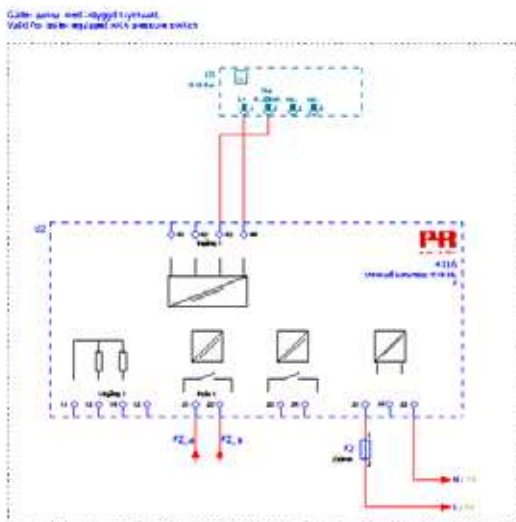

Input: Current
Range: 4-20mA
Unit: bar
Displays: 11.11
Min: 0.0
Max: 16.0
Disp: Rel
Step R1func: Window
R1.cont: C.I.W
Setp.Lo: 0.25
Setp.Hi: 3.85 eller 5.85
R1.Hyst: 0.0

6.5 Overheating protection (max. thermostat) ³

The boiler is equipped with an overheating protection (max. thermostat Tz) which is set on 105° ±5° C. If exceeded the maneuver to the boiler contactors will break and provides a signal that triggers the circuit breakers. The max thermostat resets at about 70 ° C. Before the boiler has cooled down, it is not possible to reset the circuit breaker and acknowledge the alarm on the display.

To restart the boiler, the circuit breakers on the inside must be reset and the alarm on the display acknowledged.

7. Accessories

Accessories Eco-series electric boilers		
Art. No.	Image	Designation
3366-9005	1	GSM Alarm (Battery-powered)
584196401	2	Outdoor temperature sensor, incl. 15 m cable
585513301	3	BMS / Internet module
1118404-01	4	3 current sensors for secondary measurement, Max. 5A. Excl. current transformer
3364-3065	5	Cable flange FL21 1x16-300 mm ²
3364-3066	5	Cable flange FL 21 2x16-300 mm ²
6000-0501		Pipe system EL 500 Eco accessory 1 MW



1.



2.



3.



4.



5.

8. Control system

Osby Parca's new Eco series of electric boilers has an advanced but easy-to-use control system with a touchscreen via which all settings can be made.

Control system functions:

- monitors all electric boiler functions
- allows for individual settings
- displays the desired values for e.g. temperature, operating time, energy consumption, and fault alerts
- enables simple and structured settings and troubleshooting.

Factory values

Electric boilers in the Eco series come with factory-set values as standard. These are monitored by the control system, which constantly ensures optimal functionality and economical operation. These values can be easily changed if required.

Menu structure

The product's menus are described on the following pages. An overview is provided first, followed by a detailed description of each menu.



When connecting the control voltage, a start-up image is displayed while the system check is being performed.



Home screen and main menu

8.1 Factory-set values

Step Time	30 sec
Max. temp	100 °C
Min. temp	20 °C
Set point	80 °C
Delta T	4 °C
Lang.	Eng

9. Menu overview

Home screen



Alarm menu



Operating time, energy calculator and highest boiler temperature menu



Advanced settings menu



Advanced settings menu



Time, date and language menu

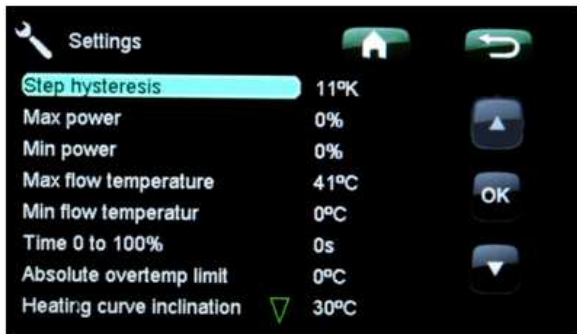

Settings menu

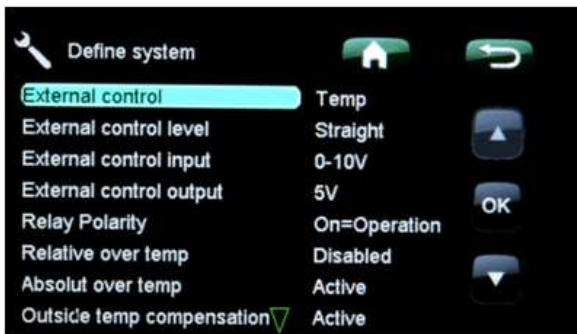

Define system menu



Quick start menu

Setting type menu



BMS communication menu



Service menu

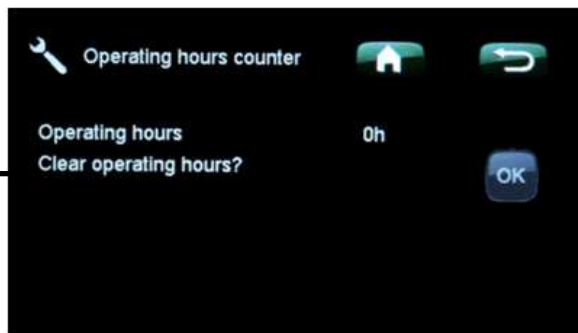
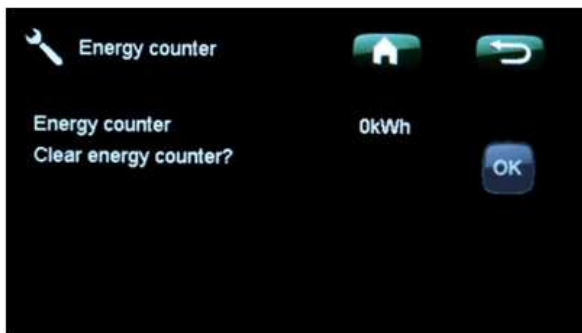
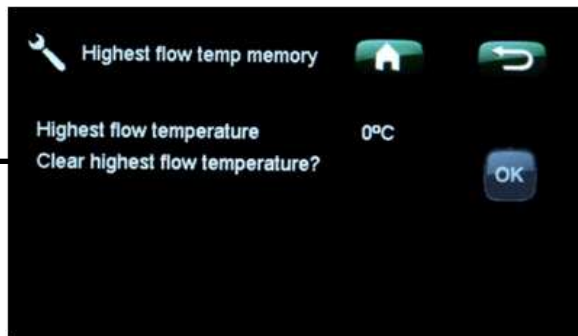
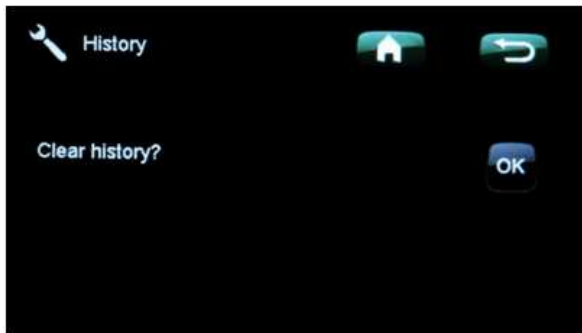

Alarm menu



Alarm description menu



Operating history menu



Graph and chart menu

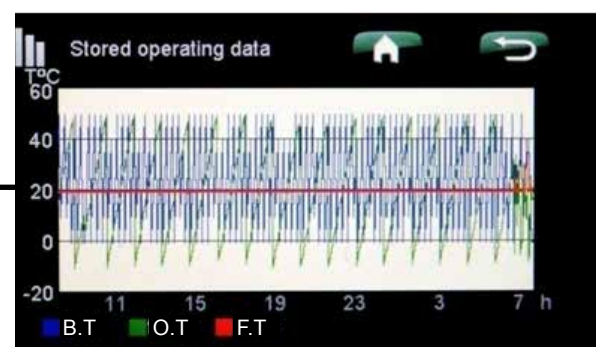

Define system menu

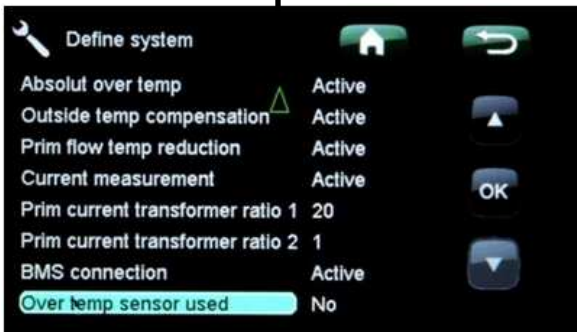
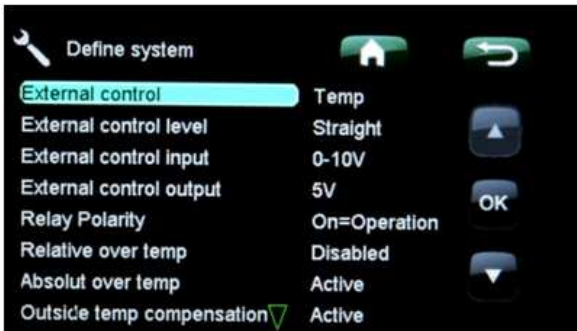

10. Detailed menu descriptions

All settings can be configured directly on-screen using the easy-to-read control panel. The large icons function as buttons on the touchscreen.

Operational and temperature information is also displayed here. You can easily access the different menus to view operational information or set your own values.

10.1 Home screen

This menu is the system's home screen. An overview of the current operational data is provided here.

If a button is not pressed within 2 minutes, the system will revert to this menu screen. All other menus can be accessed from here.

NOTE! Some menus are only displayed if their function is active.



10.2 Description of icons



Stop button

Stops boiler operation. The boiler enters Standby mode.



Start button

Starts boiler operation. The boiler enters Idle mode for approx. 5 seconds before the first output stage begins.



Operational info

Current operational data for the boiler is displayed here. Also displays historical operational data.



Advanced

Electric boiler and system settings and servicing are done here.



Alarm

Displays the alarm menu and alarm history.



Active alarms

Active alarms are displayed here along with a clear description of the alarm and actions for resetting.



Operational and alarm history

The total number of hours in operation are displayed here.



Quick start

Here, the remaining time for delays can be viewed, and the function can be overridden.



Home

Press the Home button to return to the home screen.



Return

Press the Return button to return to the previous page/screen.



OK

Press the OK button to highlight and confirm text and selections in the menus.



Information

Displays alarm descriptions and help text.



Reset

Used to reset an alarm.



Service indicator

A flashing icon indicates that it is time for the boiler to be serviced.



Service

Advanced settings must be made by a professional.



Time & Language

Settings for date, time and preferred menu language.



Settings

Opens the boiler's Settings menu.



Define system

The heating system's structure can be set/changed here.

10.3 Main menu

All other menus can be accessed via the main menu. It displays the boiler model, as well as output, time & date, status, output stages, phase currents (if the function is active), boiler temperature, set point (desired boiler temperature), outdoor temperature (if the sensor is installed and the function is active). The set point can be directly adjusted using the + and - buttons. Operation can always be stopped with the 0 button, regardless of how the boiler is controlled (analogue signal, BMS, etc.). However, the boiler cannot always be started with the 1 button. This is contingent on the way the boiler system is controlled. The reason for this is explained later in the manual under the menu that manages this function.



The example above shows the values for when the boiler uses current measurement.

10.4 Alarm menu



All alarms and operational disruptions are indicated by the alarm icon flashing red. When the icon is pressed, the menu displaying the active alarm is opened. The arrows can be used to highlight the alarm you wish to investigate. Press the ? button for a description of the alarm.



The example above shows how system alarms are presented.

10.4.1 Alarm description



The system has 18 different alarm descriptions. If the alarm cannot be reset, the RST button will be dim. This may mean that the alarm is still active or that any component in the safety equipment have not been reset. The alarm description explains why the alarm has been triggered, how to check a sensor for example, and how to reset.

If the fault cannot be reset, you will be advised to contact Support. This may happen if e.g. the relay board has broken.



The example above shows an alarm description for the boiler temperature sensor.



The alarm can be reset



The alarm cannot be reset

10.4.2 Operational information



The total number of hours the boiler has been in operation can be viewed here. The energy calculator displays the total number of produced kWh as well as the boiler's highest temperature.



10.4.3 Saved operational info



The boiler's operational information for the last 24 hours is displayed here. Actual time is displayed on the far right, and the last 24 hours on the far left. The time "rolls" forward.

The green curve is the current outdoor temperature.

Red is the primary flow temperature.

Blue is the boiler temperature.

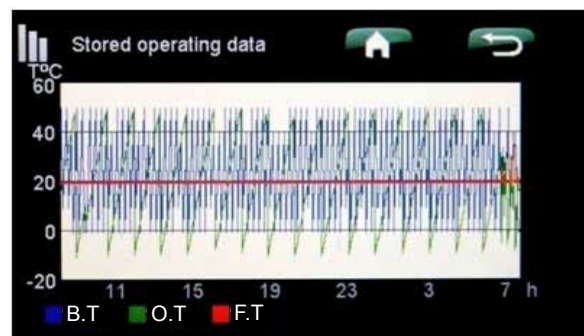

10.5 Advanced



This menu contains five submenus. Time & Language, Settings, Define System, Service and Quick Start

Also displayed here is the boiler's article number, serial number, and program versions for the relay board and panel.

Time & Language has settings for language, date and time.

The settings are used by both the installer and user to set values and functions.

Define System is used to define how the boiler is to be controlled, to specify limit values and communication.

Service is used for troubleshooting, diagnostics, history, program updates and to enter the reset PIN code.



10.6 Settings



Boiler values and functions can be set here. The functions displayed depend on how the system has been defined. Use the arrows to select the desired function. Press OK to open, and use the + and - buttons to increase/decrease values or activate/deactivate functions.

- Stage hysteresis (1...16°C)
- Max. power (0...100%)
- Min. power (0...100%)
- Max. flow temperature (0...100°C)
- Max. flow temperature (0...100°C)
- Step rate (20...240 sek)
- Relative over-temp limit (0...15°C)
- Absolute over-temp limit (0...105°C)
- Heating curve inclination (30...60°C)
- Heating curve adjustment (-10...+10°C)
- Flow temp reduction (-15...+15°C)
- Max boiler temperature (40...100°C)
- Mains fuse size (16...2000A)
- Main current margin (0...50A)
- BMS communication (only visible when active)
- Factory settings

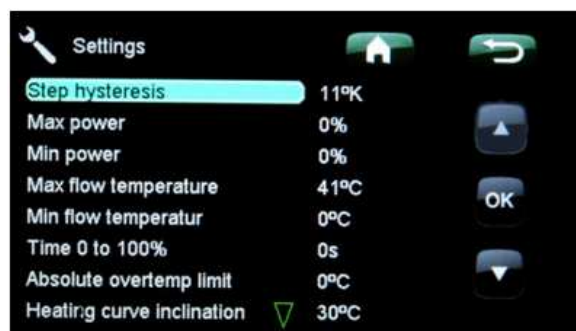

10.7 Quick start



Activates if the boiler has been without power for more than 3 minutes.

The current duration of the 1h delay can be viewed here, and an override to quick-start the boiler directly can be performed.

Limits the boiler's power to about 25% of the total power.

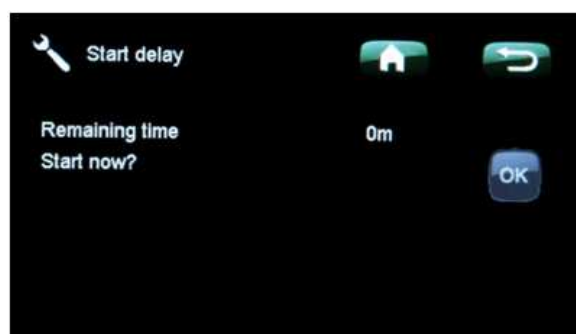

10.8 Time & Language



Language is selected by pressing the flags. To set the time, press OK and then use + and - to go up or down. The date is set in the same way.



10.8.1 Define system



How the boiler will be controlled is defined here, limit values can be specified and functions can be managed.

- Internal control (temp/power)
- External control (none/temp/power)
- External control level (Straight/inverted)
- External control input (0-5V, 0-10V, 0-20mA, 4-20mA)
- External control output (0-5V, 0-10V, 0-20mA, 4-20mA)
- Relay polarity (alarm/operation)
- Relative over-temp (active/disabled)
- Absolut over temp (Always active)
- Outdoor temp compensation (active/disabled)
- Prim flow temp reduction (active/disabled)
- Current measurement (active/disabled)
- Prim current transformer ratio 1 (10...1000)
- Sec current transformer ratio 2 (5, fixed value)
- BMS connection (active/disabled)
- Heat exchanger used (yes/no)
- Tariff active (closed contact/disabled)
- External control Start/Stop (active/disabled)

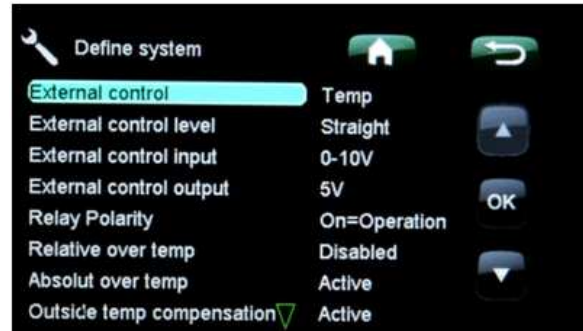

10.8.2 Service



Service is used for troubleshooting, diagnostics, history, program updates and reset. To reset saved operational history and the service timer, a 4-digit PIN code must be entered.

- Service code
- Write log USB (yes/no)
- Function test (opens new menu)
- Update SW from USB (opens new menu)
- Backup/Restore settings (opens new menu)
- Reset max. temperature (PIN code)
- Reset operating time calculator (PIN code)
- Reset energy calculator (PIN code)
- History (PIN code)
- Service timer (PIN code)

Also see chapter 4, Servicing.

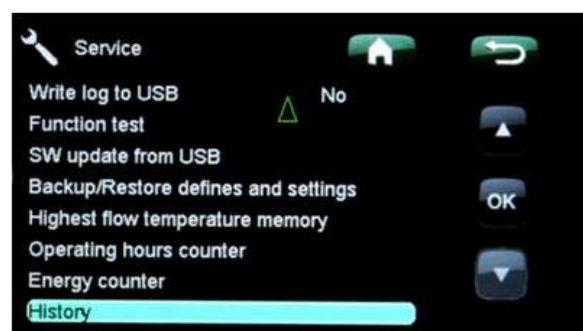
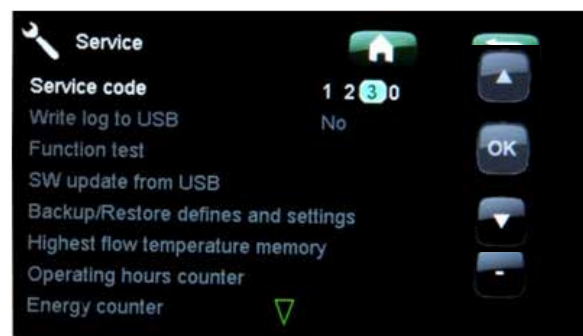

10.9 Write log to USB

Requires a USB flash drive to be plugged into the panel's port. Logs operational data, inputs and outputs to a file on the USB flash drive every 30 seconds for 24 hours.

Used by Osby Parca for advanced analyses of the boiler functions.

10.10 Function Test

Function testing allows simple system status troubleshooting to be carried out. When function testing is active, the boiler's normal functions are switched off. Ap04 refers to connector A, position 4 on the relay board. All inputs are off and cannot be changed. These can only be read. If, for example, a sensor displays -999 or +999, this means that the sensor's input is open and short-circuited, respectively.

Outputs are on and can be changed. Use the arrow buttons to select the desired position for testing, then press OK and + or - to switch between on/off. If no menu selection is made within 5 minutes, the panel will revert to the main menu.

Inputs

- 230 V Safety circuit
- 230 V Interruptible power
- Boiler temp reduced
- Tariff
- Outdoor sensor
- Room sensor = external Start/Stop
- Boiler temp sensor
- Internal temp sensor relay board
- External set point
- Phase current L1
- Phase current L2
- Phase current L3
- Internal raw voltage
- System temp sensor
- Temp sensor heat exchanger out
- Temp sensor heat exchanger in

Outputs

- Output relay 1 (on/off)
- Output relay 2 (on/off)
- Output relay 3 (on/off)
- Output relay 4 (on/off)
- Output relay 5 (on/off)
- Output relay 6 (on/off)
- Output relay 7 (on/off)
- Output relay 8 (on/off)
- Output relay 9 (on/off)
- Output relay 10 (on/off)
- Cabinet fan (on/off)
- External set point input config. (mV/Ma)

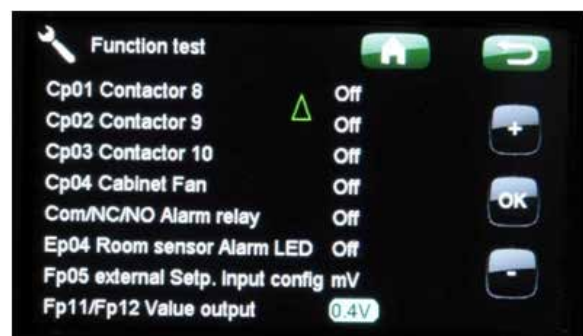

10.10.1 Update SW from USB

When the control system needs to be updated, select this option from the Service menu. Updating is performed with a USB flash drive plugged into the panel's port. Then press OK in the menu. The program is written to the panel. The system will then restart. The boiler displays the start-up screen while a system check is done, after which the main menu will be displayed. Boiler updating is now complete.



Prior to start, check to ensure the settings made have not changed after the update.

10.10.2 Backup/reset settings from USB

Insert a USB flash drive into the panel's port. Then select the Backup or Reset menu, press OK.

10.10.3 Reset highest boiler temperature

This menu displays the highest temperature reached by the boiler and shows a reset prompt. Pressing OK resets the value to zero. PIN code is required to access the menu*.

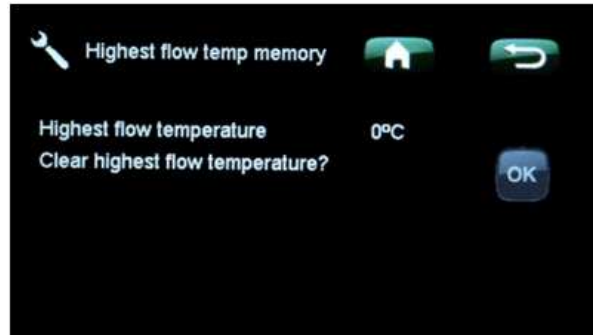

10.10.4 Reset operating time calc.

This menu displays the total number of hours the boiler has been in operation and shows a reset prompt. Pressing OK resets the calculator to zero. PIN code is required to access the menu*.

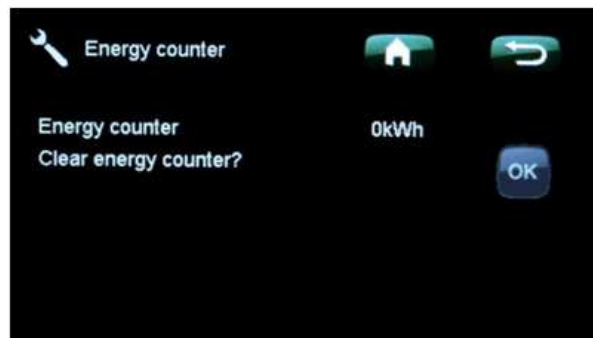

10.10.5 Reset energy calculator

This menu displays the total number of produced kWh and shows a reset prompt. Pressing OK resets the calculator to zero. PIN code is required to access the menu*.

10.10.6 Reset history

The menu shows a reset history prompt. Pressing OK resets the graphs. PIN code is required to access the menu*.

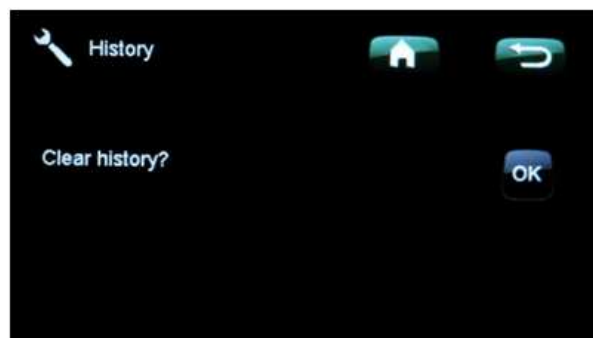

10.10.7 Service timer

Shows time remaining until the next service. The interval length between services is set here. This function can be deactivated after the warranty has expired.

* PIN code is sent when the warranty registration is done.

10.10.8 BMS Building Management automation

To facilitate integration with overall systems, RS485 and Modbus are used. This requires a module (BMS/Internet art.no: 585513301) to be connected to the panel with the supplied cable. BMS/Internet is an optional extra and not included in the delivery.

Adress, Baud rate, Paritet, Stopp bit and Timeout are set to match the data at the other end. There is no right or wrong, as long as the data is the same at both ends.



10.10.9 BMS variables

These variables are available:

Read-only register

Reg no.	Function	Type	Unit	Direction	Comment
1	Register version	U16		R	1 = This version
2	Display software version	U16		R	
3	Relay board hardware version	U16		R	
4	Article no. high value	U16		R	Always displays 3317
5	Article no. low value	U16		R	Always displays 2015
6	Serial no. high value	U16		R	
7	Serial no. low value	U16		R	
8	Operating time high value	U16	kh	R	Max. 64 Mh = 7,300 years
9	Operating time low value	U16	0.1 h	R	
10	Highest boiler temp value	S16	0.1°	R	
11	Energy calculator high value	U16	10 MWh	R	Max. 640 TWh
12	Energy calculator low value	U16	kWh	R	
13	Boiler status	U16		R	0 = Off, 1 = Wait, 2 Active
14	1h delay	U16		R	0=Deactivated, 1=Activated
15	Boiler temp	S16	0.1°	R	
16	Outdoor temp	S16	0.1°	R	
17	Reserved				Room temp
18	Relay board temp	S16	0.1°	R	
19	Phase current L1	S16	0.1A	R	Max. 3 kA
20	Phase current L2	S16	0.1A	R	
21	Phase current L3	S16	0.1A	R	
22	Boiler output	S16	kW	R	Max. 32MW
23	System temp sensor	S16	0.1°	R	Optional
24	Temp sensor from heat exchanger	S16	0.1°	R	Optional
25	Temp sensor to heat exchanger	S16	0.1°	R	Optional
26	Active BMS alarms low value	U16		R	Bit encoded: Bit 0 alarm 0... Bit 15 alarm 15
27	Active BMS alarms high value	U16		R	Bit encoded Bit 0 alarm 16... Bit 4 alarm 20

Read/Write register

50	Set point temp	S16	0.1°	R/W	
51	Set point output	S16	%	R/W	
52	Heating curve ascension/inclination	S16	0.1°	R/W	
53	Heating curve adjustment	S16	0.1°	R/W	
54	Reduced boiler temp	S16	0.1°	R/W	
55	Boiler start	S16		R/W	0 = Stop, 1 = Start Reading returns 999
56	Reset alarm low value	U16		R/W	Bit encoded 1 = reset Alarm 0..15 Reading returns 0xFFFF
57	Reset alarm high value	U16		R/W	Bit encoded 1 = reset Alarm 16..17 Reading returns 0xFFFF

NOTE! If one try to read an invalid adress the answer from BMS will be code 0x83 ERROR.
The user must clarify that any invalid addresses will not be read or accept to deal with the problem.

These are the valid commands for Modbus communication:

- 03 (0x03) Read Holding Registers
- 06 (0x06) Write Single Register
- 16 (0x10) Write Multiple registers
- 23 (0x17) Read/Write Multiple registers

Max. read and write speed: 1000 mS

10.11 Outdoor Compensation – UTK

Once an existing sensor has been defined, the outdoor temperature will be displayed in the main menu.



The heating curve defines the starting value for the boiler temperature. The outdoor temperature generates regulation of the boiler temperature.

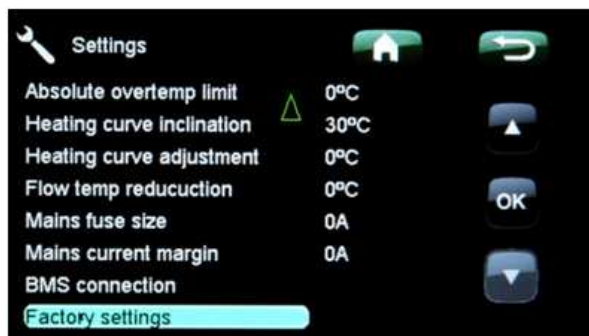

10.11.1 Heating curve ascension/ inclination

The curve can be set between 30° and 60° inclination. In the example below, the set heating curve's inclination provides a boiler temperature of 60 °C when the outdoor temperature is -15 °C.

Primary boiler temperature

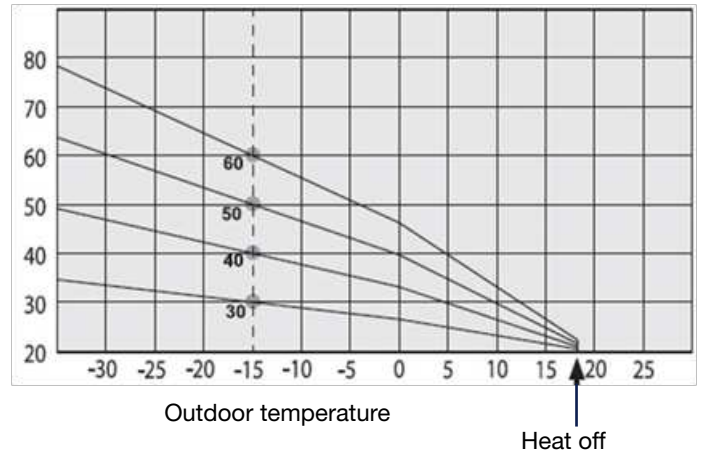

10.11.2 Heating curve adjustment

The heating curve can be adjusted in parallel with the desired value in order to adapt to different systems. Adjustment values are -10 °C... +10 °C.

Inclination 50 °C
Adjustment +5 °C

Inclination 50 °C
Adjustment 0 °C

Primary boiler temperature

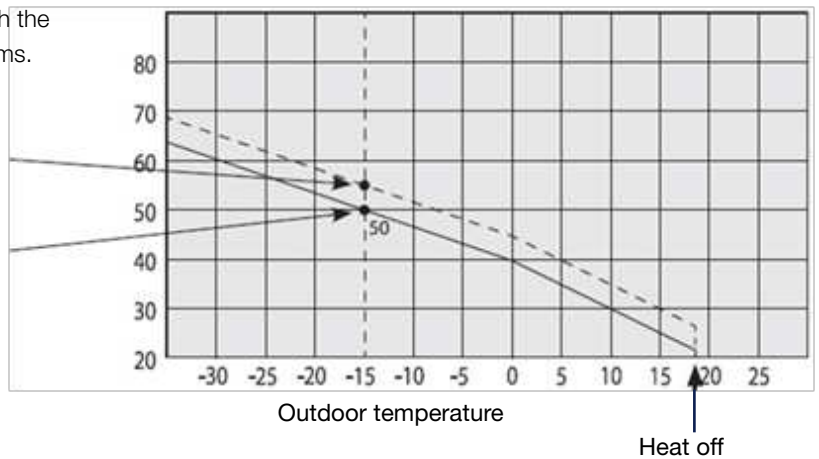

10.11.3 Highest primary boiler temperature

Highest permitted temperature for the heating system.

10.11.4 Lowest primary boiler temperature

Lowest permitted temperature for each heating system

One example

Inclination 60 °C
Adjustment 0 °C

In this example, the highest permitted primary flow temperature has been set to 55 °C. The lowest temperature is 27 °C (summertime compensation or systems unable to tolerate very high temperatures).

Primary boiler temperature

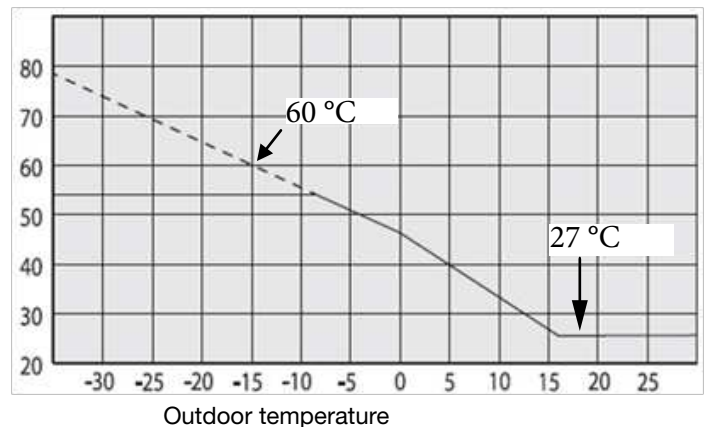

10.11.5 Reduced boiler temperature

This setting defines the number of degrees by which the boiler temperature is reduced in the heating system when input is closed. Adjustment values are -15 °C... +15°C.

10.11.6 Diagram boiler temperature

Boiler temperature when external control

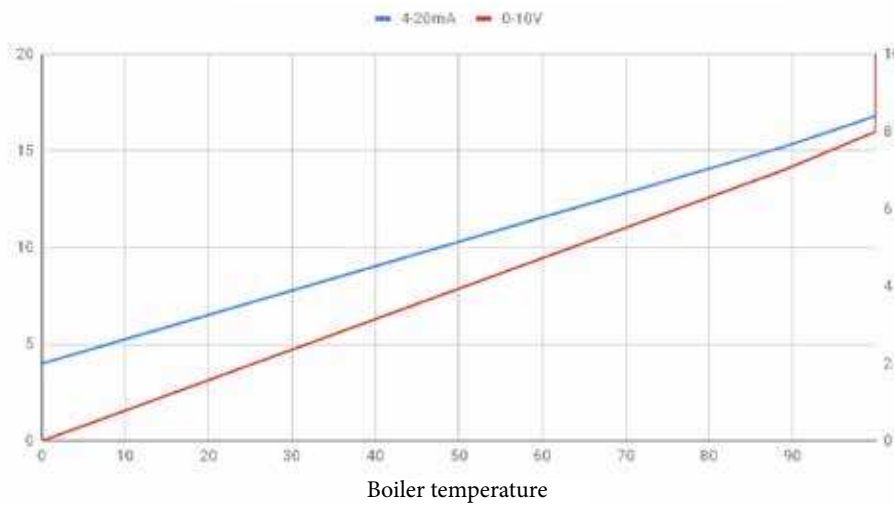

10.12 Stage regulator

The regulator utilises stage numbers. These are fixed in the system and cannot be set manually.

Output in percent

Calculated by using the boiler model's rated output and the output of connected stages. This value can be configured to analogue output.

Output set point in percent

Set point in percent is converted to an output stage. This is used to limit the stage regulator.

Overcurrent

No comparison of the next output stage's expected current increase/decrease. The current margin defined in the Settings menu is used to reconnect an output stage. Explained in more detailed under the "Current Overload" section.

Stage duration

Stage duration can be increased in the Settings menu.

NOTE! Initial stage duration cannot be adjusted or changed. It is fixed at 16 seconds.

10.13 Delta T, deadband

The function of delta T is to produce the most obtuse temperature angle possible before the set point is reached. If delta T is too small, there is a significant risk of major temperature fluctuations. This value is factory-set at 4 °C, and is adapted according to the heating system in which the boiler is installed.

10.14 Deadband range

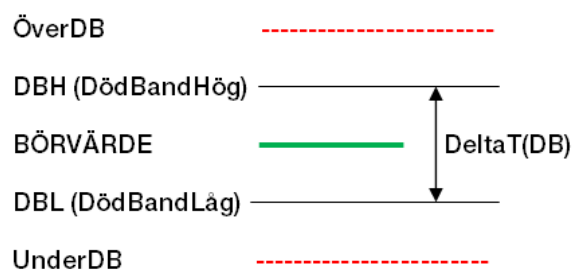

The temperature is higher than the deadband

The output stage is disconnected after each step.

The temperature is within the deadband

The stage regulator does nothing.

The temperature is lower than the deadband

The output stage is connected during the step depending on the temperature's tendency.

10.15 Current overload

The current controller uses the highest measured current value for phases L1, L2, and L3. If this current value exceeds the set value of the main fuse, the temperature controller is overridden by the stage regulator downshifting. In this mode, the temperature controller is only permitted to downshift or retain the present value.

If the current value + current margin is less than the value of the main fuse, the temperature controller is permitted to increase the stage output. The current margin is set in the Settings menu.



10.16 Output control

The regulator utilises normal temperature control. The output stage is not permitted to increase above the output set point. When the external output set point changes, the regulator follows the signal and shifts up every 16 seconds.

10.17 Current limitation

If necessary, the output of the boiler can be limited when, for example, the current drawn exceeds the main fuses of the system. The connection of current sensors to the system-specific current transformers' 0–5 A side must be done in accordance with the boiler's associated wiring diagram. The function is activated in the Define System menu. Here, the current transformer's conversion can be specified (primary and secondary side).

10.18 Current sensors

As depicted in the illustration, the current sensors must be mounted to the current transformer's cabling. For connection to the boiler, please refer to the actual model's wiring diagram. Current sensors are available from Osby Parca as boiler accessories.



System-specific current transformer

These current sensors can be ordered from Osby Parca. Art. no. 1118404-01

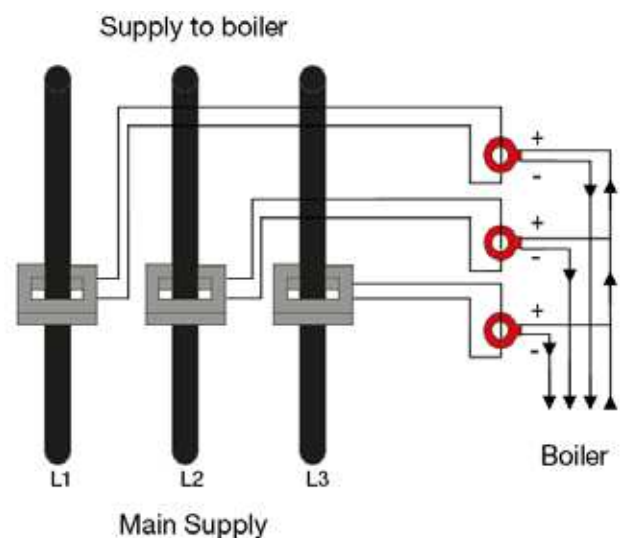

10.19 Alarm messages



In the event of a system alarm or fault, the alarm icon will flash red. When the icon is pressed, the alarm menu will be displayed along with a message describing the alarm, e.g. E01 Primary flow sensor. If several alarms are active, they will be displayed sequentially. A persisting fault must first be rectified before it can be reset. Some alarms are reset automatically if the fault ceases. Press the Info button for a description of the alarm and to reset.

This menu explains why the alarm was activated and how it can be reset. The system is able to display a total of 18 alarm messages (8 at a time).

Alarm messages

E00 Relay board memory error

E01 Boiler temp sensor

E02 High cabinet temperature

E03 Cabinet overheated

E05 Outdoor temp sensor

E06 External control signal deviation

E07 Safety circuit tripped

E08 Boiler temperature too high

E09 Communication error relay board

E10 Communication error BMS.

E11 Phase L1 Missing

E12 Phase L2 Missing

E13 Phase L3 Missing

E14 USB error

E15 Room sensor

E16 System temp sensor from boiler

E17 Temp sensor from exchanger

E18 Temp sensor to exchanger

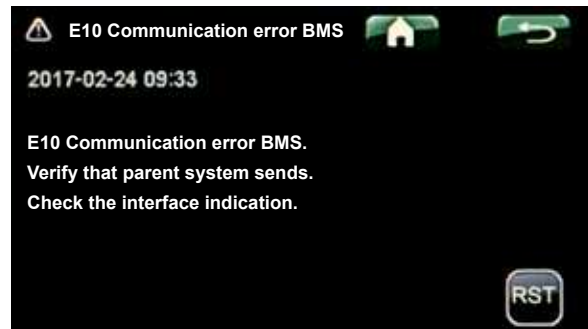

10.20 External power

With a closed potential-free contact from overall systems or other external circuits, the boiler can be started or stopped provided the safety circuit conditions are met. When the circuit is broken the boiler quickly downshifts and enters OFF mode. When the circuit is closed again, the boiler first enters STANDBY mode and then, once the step duration permits, ON mode.

11. Sensor resistances

Boiler temp sensor NTC 22

Temperature °C	NTC 22 Resistance kΩ
130	800
125	906
120	1027
115	1167
110	1330
105	1522
100	1746
95	2010
90	2320
85	2690
80	3130
75	3650
70	4280
65	5045
60	5960
55	7080
50	8450
45	10130
40	12200
35	14770
30	18000
25	22000
20	27100
15	33540
10	41800
5	52400
0	66200
-5	84750
-10	108000
-15	139000
-20	181000
-25	238000

Outdoor sensor NTC 150

Temperature °C	NTC 150 Resistance Ω
70	32
65	37
60	43
55	51
50	60
45	72
40	85
35	102
30	123
25	150
20	182
15	224
10	276
5	342
0	428
-5	538
-10	681
-15	868
-20	1115
-25	1443
-30	1883
-35	2478
-40	3289

NOTE! The sensors must be disconnected before measuring the resistance!

12. Spare parts Eco series

Immersion heaters with packings					
Boiler (kW)	Art. no.	Designation	Insertion length (mm)	Packing	Designation
36	7612027-01	Immersion heater, complete 18.2 kW / 230 V	485	7112185-02	Packing cartridge EL 36 / EL 50
50	3311-0040	Immersion heater, complete 25 kW / 230 V	485	7112185-02	Packing cartridge EL 36 / EL 50
69-504	7612000-05	Immersion heater 9 kW / 230/400 V / 2" thread	820 ±16	7616507-01	O-ring EPDM, 70 g peroxide
69-504	7612000-09	Immersion heater 15kW / 230/400 V / 2" thread	1070 ±20	7616507-01	O-ring EPDM, 70 g peroxide
69-504	7612000-09/1	Immersion heater 15kW / 230/400 V / 2" thread	685	7616507-01	O-ring EPDM, 70 g peroxide
69-504	7612000-14	Immersion heater 21 kW / 400 V / 2" thread	1320 ±26	7616507-01	O-ring EPDM, 70 g peroxide
69-504	7612000-14/1	Immersion heater 21 kW / 400 V / 2" thread	900	7616507-01	O-ring EPDM, 70 g peroxide

Air filter, fan & control system		
Boiler (kW)	Art. no.	Designation
69-156	3381-0302	Replacement filters EFA200 5-pack
120-504	3381-0303	Replacement filters EF250/300 5-pack
120-504	3381-0305	Filter fan EF300 256 m ³ /h 230 VAC
36-504	587057301	Touchscreen (Serial number must be specified at order)
36-504	583742307	Boiler temp sensor ECO L=2.5 meter
36-504	3317-2015	Relay board electric boiler ECO

Thermostats/High pressure switches		
Boiler	Part no.	Designation
69-504 kW	7020160-05S	Overheating protection (max.thermostat)
Boilers with integrated safety system		
69-504 kW	7020160-05S	Overheating protection (max.thermostat)
69-504 kW	3366-0601	Pressure transmitter (sender). Accessories: Receiver 3395-3253 and display 3395-3254

We also refer to the associated “SPARE PARTS LIST” at the wiring diagram for the actual boiler.

13. CE certificate



FÖRSÄKRAN OM ÖVERENSSTÄMMELSE DECLARATION OF CONFORMITY (CE-intyg / CE-Certificate)

**LVD 2014/35/EU
EMC 2014/30/EU**

Produkt: Elpanna / Electric boiler

Fullständigt produktnamn/nummer/Full identification of the product :

Modell/Type : El 160 Eco Effektområde/Capacity : **69 - 156 kW**

Övrig information: _____

Ett urval av produkten har bedömts och funnits vara i överensstämmelse med /
A Sample of the product has been assessed and found to be in conformity with :

Direktiven 2014/30/EU (EMC-direktivet) och 2014/35/EU (Lågspänningsdirektivet)
Directive 2014/30/EU (EMC-directive) and 2014/35/EU (Low Voltage Directive)
Ecodesign 811/2013/EU labelling and 813-814/2013/EU Commission regulation

Följande standarder har använts vid testning/bedömning/
Following standards were used in assessing:

EMC (gällande lätt industri eller industriföremål samt för fastighetsbruk /
regarding light industry or industrial equipment and for real estate use)

EN 61000-6-4 : 2007 , A1 :2011
EN 61000-6-2 :2005
EN 61000-4-2
EN 61000-4-3
EN 61000-4-4
EN 61000-4-5
EN 61000-4-6
EN 61000-4-11

Osby 2018-01-05

.....
Ort och datum / Place and date

.....
(Namnteckning / Signature)
Dennis Eliasson General Manager
Enertech AB Osby Parca Div.

**FÖRSÄKRAN OM ÖVERENSSTÄMMELSE
DECLARATION OF CONFORMITY
(CE-intyg / CE-Certificate)**

**LVD 2014/35/EU
EMC 2014/30/EU**

Produkt: Elpanna / Electric boiler

Fullständigt produktnamn/nummer/Full identification of the product :

Modell/Type : **El 500 Eco** Effektområde/Capacity : **150 - 504 kW**

Övrig information: _____

Ett urval av produkten har bedömts och funnits vara i överensstämmelse med /
A Sample of the product has been assessed and found to be in conformity with :

Direktiven 2014/30/EU (EMC-direktivet) och 2014/35/EU (Lågspänningsdirektivet)
Directive 2014/30/EU (EMC-directive) and 2014/35/EU (Low Voltage Directive)
Ecodesign 811/2013/EU labelling and 813-814/2013/EU Commission regulation

Följande standarder har använts vid testning/bedömning/
Following standards were used in assessing:

EMC (gällande lätt industri eller industriföremål samt för fastighetsbruk /
regarding light industry or industrial equipment and for real estate use)

EN 61000-6-4 : 2007 , A1 :2011
EN 61000-6-2 :2005
EN 61000-4-2
EN 61000-4-3
EN 61000-4-4
EN 61000-4-5
EN 61000-4-6
EN 61000-4-11

Osby 2020-01-27

.....
Ort och datum / Place and date



.....
(Namnteckning / Signature)
Dennis Eliasson General Manager
Enertech AB Osby Parca Div.

14. Appendices

- Circuit diagram
- Warranty document



Subject to errors or updates made after this edition.