

Technical Description

MULTICAL® 21

flowIQ® 2101 / ..02 / ..03

Water Meter



Contents

1	General description.....	7
1.1	Front plate	8
2	Approvals	9
3	Technical data	12
3.1	Mechanical data	12
3.2	Electrical data	12
3.3	Materials.....	13
3.4	Frequency settings.....	13
4	Water meter types.....	14
4.1	MULTICAL® 21 / flowIQ® 2101	15
4.2	MULTICAL® 21 – France.....	16
4.3	MULTICAL® 21 / flowIQ® 2101 - India	16
4.4	MULTICAL® 21 – Republic of South Africa.....	17
4.5	flowIQ® 2102 – Australia	17
4.6	flowIQ® 2102 – Chile	18
4.7	flowIQ® 2102 – Mexico.....	18
4.8	flowIQ® 2103 – Brazil.....	19
5	Type overview.....	19
5.1	Ordering.....	19
5.2	Type overview – MULTICAL® 21 / flowIQ® 2101	20
5.3	Type overview – MULTICAL® 21 – France	21
5.4	Type overview – MULTICAL® 21 – Republic of South Africa	22
5.5	Type overview – flowIQ® 2102 – Australia.....	23
5.6	Type overview – flowIQ® 2102 – Mexico	24
5.7	Type overview – flowIQ® 2102 – Chile	25
5.8	Type overview – flowIQ® 2103 – Brazil	26
6	Accessories.....	26
7	Configuration	27
7.1	Configuration - MULTICAL® 21 / flowIQ® 2101 / flowIQ® 2102	27
7.2	Configuration - flowIQ® 2103	28
8	Communication.....	29
8.1	Optional data packages – Wireless M-Bus	29
8.2	Wired M-Bus version of flowIQ® 2101	31

9 Data Packages Wireless M-Bus modules..... 34

10 Optional data packages – Sigfox installations 35

11 Sigfox modules 35

11.1 Data Packages..... 35

11.2 Sequences..... 35

12 Measurements 36

12.1 Measurement accuracy 36

12.2 Temperature measurements..... 38

13 Measuring principle 38

13.1 Ultrasound with piezo ceramics 38

13.2 Principles 38

13.3 Transit time method 39

13.4 Calculation of flow volume 41

13.5 Flow limits..... 42

14 Pressure loss 43

14.1 Pressure loss – MULTICAL® 21 / flowIQ® 2101 /2102 43

14.2 Pressure loss – flowIQ® 2103 - Brazil..... 44

15 Dimensioned Sketches 45

15.1 Dimensions, connection, weight 47

16 Installation 48

16.1 Installation requirements 48

16.2 Installation angle 51

16.3 Straight inlet 52

16.4 Operating pressure 52

17 Reading and data 52

17.1 Reading 52

17.2 Volume measurement..... 53

17.3 Data function: Target volume..... 53

17.4 Data function: Target date 53

17.5 Data function: Reverse Volume..... 53

17.6 Data function: Date/time stamp 54

17.7 Data function: Battery capacity 54

17.8 Data function: Radio disabled 54

17.9 Data function: Maximum flow and minimum flow 54

17.10 Temperature monitoring..... 55

17.11	Display functions	57
17.12	Info codes	59
17.13	Optical eye	64
18	Data loggers	65
18.1	Memory	65
18.2	Yearly, monthly and daily loggers.....	66
18.3	Optional register in data logger.....	67
18.4	Loggers.....	68
18.5	DataTool	68
18.6	Hour counter	69
18.7	Info register	70
18.8	Meter modes (settings)	72
18.9	Normal mode.....	72
18.10	Verification mode	72
18.11	Legal changes outside seal	73
19	Pulse adapter for MULTICAL® 21 / flowIQ® 2101/..02/..03.....	75
19.1	Function	75
19.2	Application – environment	76
19.3	Lifetime - Pulse Adapter	76
19.4	Connection of Pulse Adapter.....	76
19.5	Pull-up.....	77
20	Pulse Interface for MULTICAL® 21 / flowIQ® 2101 / ..02 / ..03	79
20.1	Connection Pulse Interface.....	80
21	Data communication.....	81
21.1	Transmission.....	81
21.2	RADIO OFF	82
21.3	Data Content	82
21.4	Encryption.....	82
21.5	Radio disabled	82
22	Communication (KMP).....	83
22.1	Optical eye activation	83
23	METER TOOL for MULTICAL® 21 / flowIQ® 2101 / ..02 / ..03	83
24	Troubleshooting.....	83
25	Disposal.....	84
25.1	Instructions for disposal	85

1 General description

MULTICAL® 21, flowIQ® 2101, 2102 and 2103 is an integrated and hermetically closed water meter, intended for measurement of cold and hot tap water consumption. The meter is a static water meter based on the ultrasonic principle. The water meter has been developed based on Kamstrup's experience since 1991, with development and production of static ultrasonic meters.

The water meter is been subjected to very comprehensive type tests, in order to ensure a long-term stable, accurate and reliable meter. One of the water meter's many advantages is the fact that it has no wearing parts, which entails longevity. Furthermore, the meter has a low start flow (low-flow cut-off) in only 2 l/h, which provides accurate measurement also at low water flows. In addition to this, the meter is approved with a dynamic range of up to 400.

The water meter is constructed as a vacuum chamber of moulded composite material. Thus, the electronics are fully protected against penetration of water. This means that the meter can without problems be placed in e.g. wet rooms where it is sprayed with water daily; and it is also suitable for mounting in meter pits, which are frequently filled with water. **The meter can and must only be opened by Kamstrup A/S.**

If the meter has been opened and the seals have thus been broken, the meter is no longer valid for billing purposes and factory guarantee no longer applies.

Water consumption is measured electronically, as a volume, using the ultrasound signal. Through two ultrasonic transducers, an audio signal is sent with and against the flow direction. A transducer serves both as a 'speaker' when transmitting and as a 'microphone' when a signal is received. The ultrasonic signal traveling with the flow will be the first to reach the opposite transducer, while the signal running against the flow will be received a little later. The time difference, between the two signals, can be converted into flow velocity, and thereby also into a volume. The measuring principle is called '*bidirectional ultrasound technique based on the transit time method*', which is a proven, long-term stable and accurate measuring principle.

The accumulated water consumption is displayed by the water meter in cubic meters (m³) with five digits and up to three decimals, i.e. the resolution has been extended to 1 litre only. The display has been specially designed to operate in a wide temperature range, with high contrast, regardless of lighting - and therefore easy to read - and still have long lifetime. In addition to volume reading, a graphic indication of current flow and a number of information codes are displayed.

In addition to volume reading, the water meter continuously measures the current water temperature, as well as the temperature in the meter/surroundings. Based on these measurements, the meter calculates and stores a minimum, a maximum, and an average temperature for both types of measurements each day.

All registers are saved daily, in the meter data logger (EEPROM), and are kept for 460 days, monthly data for the latest 36 months are saved, and furthermore selected data are saved annually for ten years.

The meter is fitted with an optical eye, which makes it possible to read saved consumption data and info codes, stored in the meter's data logger. Using an optical reading head, with USB connection, the optical eye, in addition, allows configuration of the meter.

The meter comes with integral data communication wireless radio¹⁾ – offering both 'Drive-by', 'Network' or Sigfox installations. The meter is powered by lithium battery (internal), providing up to 16 years' lifetime.

¹⁾ *Wired M-Bus - see section 'Wired M-Bus version of flowIQ® 2101'*

1.1 Front plate

Meter information in permanent laser engraved text.

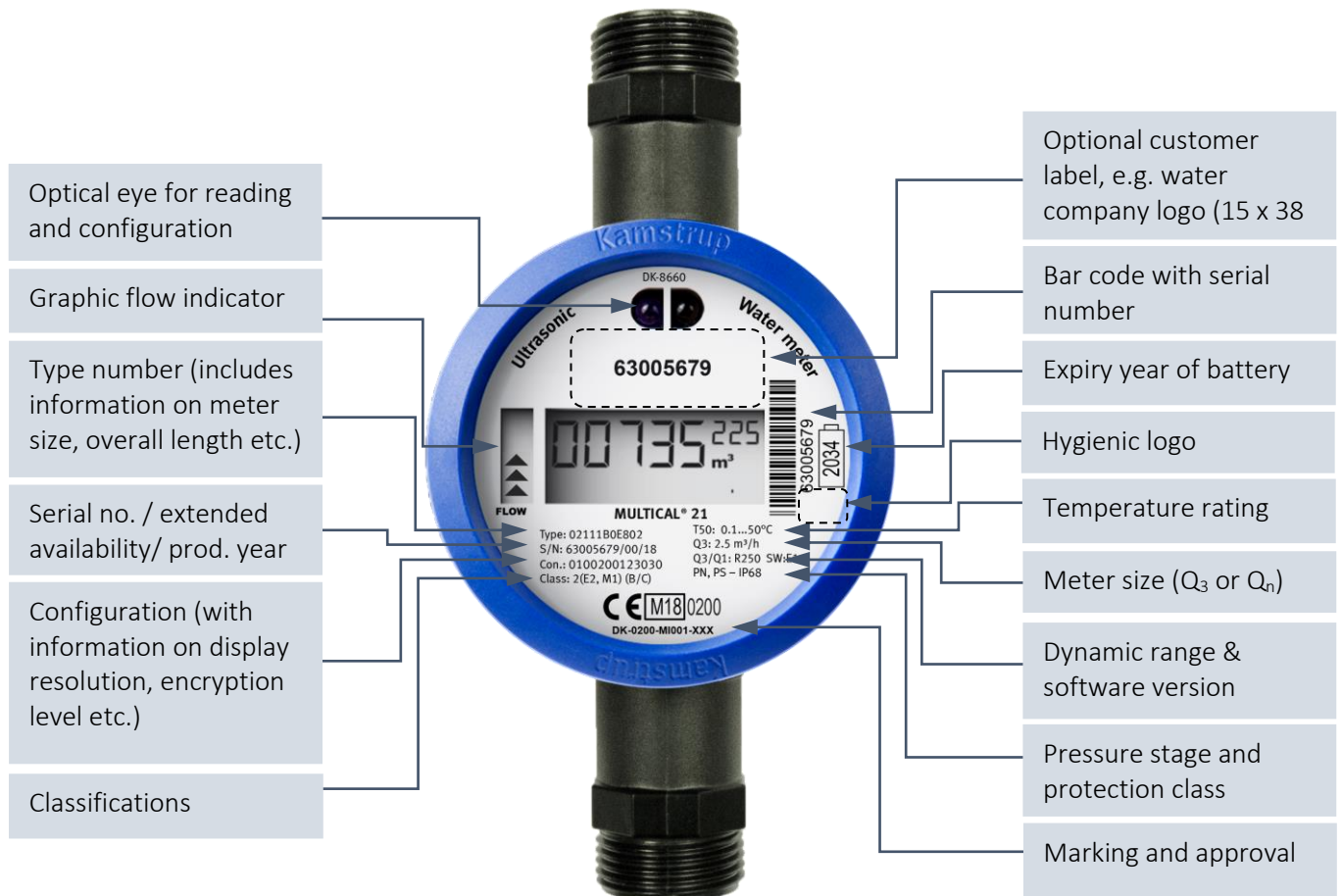

2 Approvals

The water meter has been approved for the European markets acc. to the Measurement Instruments Directive (MID) based on OIML R49*) with the with 'FORCE Certification' as notified body.

*)OIML: 'International Organization of Legal Metrology'

ATEX approval According to 2014/34/EU Equipment
intended for use in potentially explosive atmospheres, zone 2

Please contact Kamstrup A/S for further details on national approvals and verification.
(Also see table next page)

	Marking	Approved meter data	Approvals Radio/ Communication	Hygienic Drinking water approval
MULTICAL® 21	CE marking acc. to MID 	<i>Designations according to OIML R49:</i> <i>MID classifications</i> MID Cert.: B-Module: DK-0200-MI001-015 D-Module: DK-0200-MIQA-001 Sensitivity class U0/D0 Accuracy class: 2 Environment class: -Electromagnetic: E1 /E2 (Wireless M-Bus) E1 (Wired M-Bus ver.) Low Voltage Directive -Mechanical: M1 Ambient class: B / O (in-/out-doors) Climatic environment: 5...55 °C, condensing humidity	R&TTE 1999/5/EC Standard EN 13757CE approval (applies for flowIQ® 2101 Wired M-bus version) Sigfox radio zone 1 (868 MHz)	DE: DVGW W 421, KTW, W270 DK: GDV GB: WRAS NL: KIWA FR: ACS PL: PZH Atest Higieniczny CZ: Hygienic approval HU: Hygienic approval RO: Hygienic approval CH: SVGW OE: ÖVGW BE: Belgaqua Other Hygiene Approvals.

RMC symbol



flowIQ® 2102
(Australia and New Zealand)

Marking acc. to NMI NO. 14/3/23

AS/NZS 4020: 2005 Testing of product in contact with drinking water.

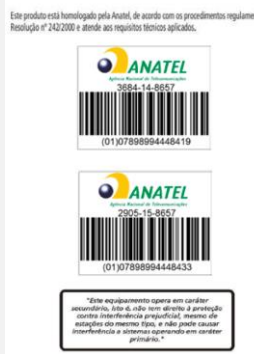
	Marking	Approved meter data	Approvals Radio/ Communication	Hygienic Drinking water approval
MULTICAL® 21 (South Africa)	SA marking acc. to SANS SA1536	Metrological class of meters SANS 1529 class C	N/A	N/A
flowIQ® 2102 (Mexico)	IFT: RCPKAF14-0979	---	ift Instituto Federal De Telecomunicaciones	N/A
flowIQ® 2102 (Chile)	---	---	Subtel	N/A
flowIQ® 2103 (Brazil)	 <p>ANATEL INMETRO ML 199 2014 Inmetro and ANATEL approval marks</p>	<p>According to Portaria Inmetro n° 246:2000</p> <p>Accuracy class: C</p> <p>Mounting position: Horizontal or vertical.</p> <p>Ambient class (OIML): B / O (in-/out-doors)</p> <p>Environment class: -Electromagnetic: E1 /E2</p> <p>Ambient temperature: 1... 50°C</p> <p>Fluid temperature: 1...40 °C</p>	 <p>Este produto está homologado pela Anatel, de acordo com os procedimentos regulares Resolução nº 242/2000 e atende aos requisitos técnicos aplicados.</p> <p>Certificado de Homologações N° 3684-14-8657</p>	N/A

3 Technical data

3.1 Mechanical data

Water temperature (OIML)	Cold water	0.1...30 °C (T30) or 0.1...50 °C (T50)
	Hot water	0.1...70 °C (T70) or (T30/T70) (does not apply to Sigfox meters)
(Portaria Inmetro n° 246:2000)		1...40 °C
Climatic environment		5...55 °C, condensing humidity (Mounted indoors in utility rooms and outdoors in meter pits) Avoid mounting in direct, prolonged sunlight.
Storage temperature		-25...60 °C (Empty meter) Note! A packaged water meter must not, (for the sake of the APET packaging), be stored at temperatures higher than 40 °C for periods exceeding 24 hours.
Pressure stage		
(PMA flowIQ®2102)		PN16 (approved for PN10 and PN16)
Flow sensitivity		Sensitivity to irregularity acc. to OIML R49 section 6.3.5
Velocity field class:	Upstream:	U0
	Downstream:	D0
Protection class		IP68
Weight		See section ' <i>Dimensions, connection, weight</i> '

3.2 Electrical data

Battery		3.65 VDC, lithium / C-cell or 3.65 VDC A-cell package
Battery lifetime	up to 16 years at	$t_{BAT} < 30$ °C – depending on selected module
	up to 8 years at	t_{BAT} 30-55 °C for Wired and Wireless M-Bus t_{BAT} max 35 °C for Sigfox versions
EMC data (OIML) (Electromagnetic class)		Fulfills MID class E1 and E2 (for Wireless M-Bus and Sigfox version) E1 (for Wired M-Bus version)
Sigfox classification		Class zero
Sigfox radio zone		RC1, 868 MHz, 14 dBm

3.3 Materials

Meter housing and meter pipe	Polyphenylene Sulfide (PPS) with 40 % fibreglass
Reflectors	Stainless steel, W.no. 1.4306
Cover	Glass
Top ring (sealing)	Polycarbonate (dyed)

3.4 Frequency settings

Meter type	Frequency	Settings (for Wireless M-Bus)	Standard
MULTICAL® 21 (Europe and South Africa)	868 MHz	<ul style="list-style-type: none"> Mode C1 Mode T1 - OMS (for the European market) Mode T1 - OMS BSI 	EN 13757-4 European standard for remote reading of meters
flowIQ® 2101	865.5 MHz	<ul style="list-style-type: none"> 865.5 MHz, India 	ETA Certificate
flowIQ® 2102 (Australia & New Zealand)	923 MHz	<ul style="list-style-type: none"> 923 MHz - Mode C1 	AS/NZ 4268
flowIQ® 2102 (Mexico)	923 MHz	<ul style="list-style-type: none"> 923 MHz - Mode C1 	ift
flowIQ® 2102 (Chile)	915 MHz	<ul style="list-style-type: none"> 915 MHz - Chile 	Subtel

ANATEL regulations,
(for license-free radio communication in Brazil.

flowIQ® 2103	923 MHz	<ul style="list-style-type: none"> 923 MHz, Mode C1
	434 MHz	<ul style="list-style-type: none"> 434 MHz, Mode C1

Este produto está homologado pela Anatel, de acordo com os procedimentos regulamentados pela Resolução nº 242/2000 e atende aos requisitos técnicos aplicados.



Este equipamento opera em caráter secundário, isto é, não tem direito à proteção contra interferência prejudicial, mesmo de estações do mesmo tipo, e não pode causar interferência a sistemas operando em caráter primário.

4 Water meter types

Combinations of connection, size, overall length and nominal flow – see tables below

The meter is available in versions for cold and hot water respectively.

Water meter type, determined by the country code, is named as follows:

8XX for cold water

7XX for hot water

XX = Country Code and /or time zone

YY = Communication module

Z = Battery type B or C B = A-cell package C = C-cell lithium (depending on which market)
(lifetime up to 16 years for both types)

See ordering details in section '*Ordering*'

**) Note! Non-return valve is not possible because of the short overall length*

****) At flows above 'Maximum cut-off' measurement continues corresponding to a constant flow at this value.*

4.1 MULTICAL® 21 / flowIQ® 2101

	Nom. flow Q ₃	Min. flow Q ₁	Max flow Q ₄	Dynamic range Q ₃ /Q ₁	Min. cut-off	Max cut-off **)	Pressure loss Δp at Q ₃	Connection on meter	Length	Non-return valve	Strainer pre-mounted
Type number	[m ³ /h]	[l/h]	[m ³ /h]		[l/h]	[m ³ /h]	[bar]		[mm]		
021-YY-Z0A-XXX	1.6	10	2.0	160	2	4.6	0.17	G¾B	110	Yes	Yes
021-YY-Z0B-XXX	1.6	16	2.0	160	2	4.6	0.17	G¾B	110	Yes	Yes
021-YY-Z0D-XXX	2.5	10	3.1	250	2	4.6	0.40	G¾B	110	Yes	Yes
021-YY-Z0C-XXX	2.5	25	3.1	100	2	4.6	0.40	G¾B	110	Yes	Yes
021-YY-Z0G-XXX	2.5	10	3.1	250	2	4.6	0.40	G1B	105	No *)	Yes
021-YY-Z0F-XXX	2.5	25	3.1	100	2	4.6	0.40	G1B	105	No *)	Yes
021-YY-Z0H-XXX	2.5	10	3.1	250	2	4.6	0.40	G1B	130	Yes	Yes
021-YY-Z0J-XXX	2.5	25	3.1	100	2	4.6	0.40	G1B	130	Yes	Yes
021-YY-Z0E-XXX	2.5	10	3.1	250	2	4.6	0.40	G1B	190	Yes	Yes
021-YY-Z0K-XXX	2.5	25	3.1	100	2	4.6	0.40	G1B	190	Yes	Yes
021-YY-Z0L-XXX	4.0	16	5.0	250	3.2	8.5	0.40	G1B	130	Yes	Yes
021-YY-Z0M-XXX	4.0	40	5.0	100	3.2	8.5	0.40	G1B	130	Yes	Yes
021-YY-Z0N-XXX	4.0	16	5.0	250	3.2	8.5	0.40	G1B	190	Yes	Yes
021-YY-Z0P-XXX	4.0	40	5.0	100	3.2	8.5	0.40	G1B	190	Yes	Yes

According to OIML R49 maximum pressure loss at Q₃ must not exceed 0.063 MPa (0.63 bar).

At Q₄ this results in a pressure loss of max 0.1 MPa (1 bar).

4.2 MULTICAL® 21 – France

	Nom. flow Q ₃	Min. flow Q ₁	Max flow Q ₄	Dynamic range Q ₃ /Q ₁	Min. cut-off	Max cut-off **)	Pressure loss Δp at Q ₃	Connection on meter	Length	Non-return valve	Strainer pre-mounted
Type number	[m ³ /h]	[l/h]	[m ³ /h]		[l/h]	[m ³ /h]	[bar]		[mm]		
021-YY-ZOS-X81	1.6	10	2.0	100	2	4.6	0.17	G¾B	170	Yes	Yes
021-YY-ZOT-X81	1.6	10	2.0	160	2	4.6	0.17	G¾B	170	Yes	Yes
021-YY-ZOU-X81	2.5	10	3.1	100	2	4.6	0.40	G¾B	170	Yes	Yes
021-YY-ZOV-X81	2.5	10	3.1	250	2	4.6	0.40	G¾B	170	Yes	Yes

4.3 MULTICAL® 21 / flowIQ® 2101 - India

	Nom. flow Q ₃	Min. flow Q ₁	Max flow Q ₄	Dynamic range Q ₃ /Q ₁	Min. cut-off	Max cut-off **)	Pressure loss Δp at Q ₃	Connection on meter	Length	Non-return valve	Strainer pre-mounted
Type number ¹⁾	[m ³ /h]	[l/h]	[m ³ /h]		[l/h]	[m ³ /h]	[bar]		[mm]		
021-YY-ZOA-8XX	1.6	10	2.0	160	2	4.6	0.17	G¾B	110	Yes	Yes
021-YY-ZOD-8XX	2.5	10	3.1	250	2	4.6	0.40	G¾B	110	Yes	Yes
021-YY-ZOG-8XX	2.5	10	3.1	250	2	4.6	0.40	G1B	105	No ^{*)}	Yes
021-YY-ZOH-8XX	2.5	10	3.1	250	2	4.6	0.40	G1B	130	Yes	Yes
021-YY-ZOL-8XX	4.0	16	5.0	250	3.2	8.5	0.40	G1B	130	Yes	Yes

¹⁾ Only available in cold water versions

According to OIML R49 maximum pressure loss at Q₃ must not exceed 0.063 MPa (0.63 bar).

At Q₄ this results in a pressure loss of max 0.1 MPa (1 bar).

4.4 MULTICAL® 21 – Republic of South Africa

Type number	Nom. flow	Min. flow	Max flow	Metro-logical/ Accuracy Class	Min. cut- off	Max cut-off **)	Pressure loss	Connection on meter	Length	Non-return valve	Strainer mounted
	Q _p	Q _{min}	Q _s				Δp at Q _p				
	[m ³ /h]	[l/h]	[m ³ /h]			[l/h]	[m ³ /h]				
021-YY-C01-8ZA	1.5	15	3	C	2	4.6	0.16	G3/4B	110	Yes	Yes
021-YY-C02-8ZA	1.5	15	3	C	2	8.5	0.17	G1B	105	No	Yes
021-YY-C03-8ZA	1.5	15	3	C	2	8.5	0.17	G1B	130	Yes	Yes
021-YY-C04-8ZA	2.5	25	5	C	3.2	8.5	0.18	G1B	130	Yes	Yes

At Q_s max pressure loss is 0.1 MPa (1 bar).

8ZA = Cold water meter - Republic of South Africa

Q_p: 1.5 m³/h ~ (Q₃ = 2.5 m³/h)
 2.5 m³/h ~ (Q₃ = 4.0 m³/h)

4.5 flowIQ® 2102 – Australia

Type number	Nom. flow	Min. flow	Max flow	Dynamic range	Min. cut-off	Max cut-off **)	Pressure loss	Connection on meter	Length	Non-return valve	Strainer mounted
	Q ₃	Q ₁	Q ₄				Δp at Q ₃				
	[m ³ /h]	[l/h]	[m ³ /h]			[l/h]	[m ³ /h]				
02A-YY-COD-XXX	2.5	10	3.1	250	2	4.6	0.40	G¾B	110	Yes	Yes
02A-YY-COL-XXX	4.0	16	5.0	250	3.2	8.5	0.40	G1B	130	Yes	Yes

XAC = Australia Central

XAE = Australia Eastern

XAW = Australia Western

4.6 flowIQ® 2102 – Chile

Type number	Nom. flow	Min. flow	Max flow	Dynamic range	Min. cut-off	Max cut-off ^{**})	Pressure loss	Connection on meter	Length	Non-return valve	Strainer mounted
	Q ₃	Q ₁	Q ₄	Q ₃ /Q ₁			Δp at Q ₃				
	[m ³ /h]	[l/h]	[m ³ /h]		[l/h]	[m ³ /h]	[bar]		[mm]		
02A-36-COD-8XX	2.5	10	3.1	250	2	4.6	0.40	G¾B	110	Yes	Yes
02A-36-COL-8XX	4.0	16	5.0	250	3.2	8.5	0.40	G1B	130	Yes	Yes

4.7 flowIQ® 2102 – Mexico

Type number ¹⁾	Nom. flow	Min. flow	Max flow	Dynamic range	Min. cut-off	Max cut-off ^{**})	Pressure loss	Connection on meter	Length	Non-return valve	Strainer mounted
	Q ₃	Q ₁	Q ₄	Q ₃ /Q ₁			Δp at Q ₃				
	[m ³ /h]	[l/h]	[m ³ /h]		[l/h]	[m ³ /h]	[bar]		[mm]		
02A-80-C0A-8XX	1.6	10	3.1	160	2	4.6	0.17	G¾B	110	Yes	Yes
02A-80-COD-8XX	2.5	10	3.1	250	2	4.6	0.40	G¾B	110	Yes	Yes
02A-80-COG-8XX	2.5	10	3.1	250	2	4.6	0.40	G1B	105	No	Yes
02A-80-COH-8XX	2.5	10	3.1	250	2	4.6	0.40	G1B	130	Yes	Yes
02A-80-COL-8XX	4.0	16	5.0	250	3.2	8.5	0.40	G1B	130	Yes	Yes

²⁾ Only available in cold water versions

XMC = Mexico Central

XMM = Mexico Mountain

XMP = Mexico Pacific

4.8 flowIQ® 2103 – Brazil

Type number ¹⁾	Nom. flow Q _n	Min. flow Q _{min}	Max flow Q _{max}	Dynamic range Q _{max} / Q _{min}	Min. cut-off	Max cut-off **)	Pressure loss Δp at Q _n	Connection on meter	Length	Non-return valve	Strainer mounted
	[m ³ /h]	[l/h]	[m ³ /h]		[l/h]	[m ³ /h]	[bar]		[mm]		
02C-YY-C0U-8XX	1.5	15	3	200	2	4.6	0.17	G1B	115	No	Yes
02C-YY-C0E-8XX	1.5	15	3	200	2	4.6	0.17	G1B	190	Yes	Yes
02C-YY-C0L-8XX	2.5	25	5	200	3.2	8.5	0.18	G1B	130	Yes	Yes
02C-YY-C0N-8XX	2.5	25	5	200	3.2	8.5	0.18	G1B	190	Yes	Yes

¹⁾ Only available in cold water versions

Q_n = 1.5 m³/h ~ (Q₃ = 2.5 m³/h)
 2.5 m³/h ~ (Q₃ = 4.0 m³/h)

8BB = Brasilia
 8BA = Amazon
 8BF = Fernando

Wireless M-Bus 923 MHz
 Wireless M-Bus 434 MHz

5 Type overview

5.1 Ordering

An order is initiated by stating the type number of the selected model of MULTICAL® 21/flowIQ® 210X. The type number includes information on meter type - cold or hot water, meter size, overall length, battery supply, country code etc. Some of the features included in the type number cannot be changed. Subsequently, the meter configuration is selected (which determines customer specific requirements, such as number of digits in display etc.) With this, the configuration is completed. (see following tables)

Finally, required accessories, if any, are selected, in the form of gaskets, different extension pipes, non-return valve and standard couplings. Accessories are enclosed, separately, and to be mounted by the installer.

5.2 Type overview – MULTICAL® 21 / flowIQ® 2101

Type		021-	□□	□	0	□	□	□□
Communication								
Wireless M-Bus, 868 MHz, mode C1			XX*					
Wireless M-Bus, 868 MHz, mode T1 – OMS ²⁾			XX*					
Wireless M-Bus, 868 MHz, mode T1 – BSI ²⁾			XX*					
868,5 MHz ²⁾			XX*					
868 MHz Radio disabled			XX*					
Wired M-Bus ¹⁾			XX*					
Sigfox daily values			XX*					
Sigfox daily values sequence			XX*					
Module w/disabled radio communication (Sigfox)			XX*					
* See document 5512-2336 for choice of modules								
Supply								
Battery supply A-package ²⁾								B
Battery supply C-cell ²⁾								C
Meter size								
Q3	[m ³ /h]	Connection	Length [mm]	Dynamic range				
1.6		G¾B (R½)	110	1:160		A		
1.6		G¾B (R½)	110	1:100		B		
2.5		G¾B (R½)	110	1:250		D		
2.5		G¾B (R½)	110	1:100		C		
2.5		G1B (R¾)	105	1:250		G		
2.5		G1B (R¾)	105	1:100		F		
2.5		G1B (R¾)	130	1:250		H		
2,5		G1B (R¾)	130	1:100		J		
2.5		G1B (R¾)	190	1:250		E		
2.5		G1B (R¾)	190	1:100		K		
4.0		G1B (R¾)	130	1:250		L		
4.0		G1B (R¾)	130	1:100		M		
4.0		G1B (R¾)	190	1:250		N		
4.0		G1B (R¾)	190	1:100		P		
Meter type								
Hot water meter, T70, T30/70 (OIML R49)								7 8
Country code								
Language on label etc. (Numbers or letters)								XX

¹⁾ Applies only for flowIQ® 2101 ²⁾ Only for selected markets

BSI encryption: 'Bundesamt für Sicherheit in der Informationstechnik'

5.3 Type overview – MULTICAL® 21 – France

Type		021-	□□	□	0	□	□	□□
Communication								
Sigfox daily values			XX*					
Sigfox daily values sequence			XX*					
Module w/disabled radio communication (Sigfox)			XX*					
* See document 5512-2336 for choice of modules								
Supply								
Battery supply A-package ²⁾				B				
Battery supply C-cell ²⁾				C				
Meter size								
Q3	[m ³ /h]	Connection	Length [mm]	Dynamic range				
1.6		G¾B (R½)	170	1:100			S	
1.6		G¾B (R½)	170	1:160			T	
2.5		G¾B (R½)	170	1:100			U	
2.5		G¾B (R½)	170	1:250			V	
Meter type								
Hot water meter, T70, T30/70 (OIML R49)							7	
Cold water meter, T30 or T50 (MID)							8	
Country code								
Language on label etc. (Numbers or letters)								81

²⁾ Only for selected markets

5.4 Type overview – MULTICAL® 21 – Republic of South Africa

Type				021-	□□	□	0	□	□	□□
Communication										
Wireless M-Bus, 868 MHz, mode C1				XX*						
Wireless M-Bus, 868 MHz, mode T1 – OMS				XX*						
868 MHz Radio disabled				XX*						
<i>* See document 5512-2336 for choice of modules</i>										
Supply										
Battery supply						C				
Meter size										
	Connection	Length [mm]	Accuracy Class							
1.5	G¾B (R½)	110	C					1		
1.5	G1B (R¾)	105	C					2		
1.5	G1B (R¾)	130	C					3		
2.5	G1B (R¾)	130	C					4		
Meter type										
Cold water meter, T30 or T50 (MID)									8	
Country code										
Language on label etc. (Numbers or letters)										ZA

5.5 Type overview – flowIQ® 2102 – Australia

Type				02A-	□□	□	0	□	□	□□
Communication										
923 MHz					80					
Supply										
Battery supply						C				
Meter size										
Q ₃ [m ³ /h]	Connection	Length [mm]	Dynamic range							
2.5	G¾B (R½)	110	1:250					D		
4.0	G1B (R¾)	130	1:250					L		
Meter type										
Hot water meter										7
Cold water meter										8
Country code										
Language on label etc. (Numbers or letters)										XX ^{*)}

^{*)} AC = Australia Central AE = Eastern AW = Western

5.6 Type overview – flowIQ® 2102 – Mexico

Type				02A-	□□	□	0	□	□	□□
Communication										
923 MHz				80						
Supply										
Battery supply					C					
Meter size										
Q ₃ [m ³ /h]	Connection	Length [mm]	Dynamic range							
1.6	G¾B (R½)	110	1:160					A		
2.5	G¾B (R½)	110	1:250					D		
2.5	G1B (R¾)	105	1:250					G		
2.5	G1B (R¾)	130	1:250					H		
4.0	G1B (R¾)	130	1:250					L		
Meter type										
Hot water meter									7	
Cold water meter									8	
Country code										
Language on label etc. (Numbers or letters)										XX ^{*)}

^{*)} MC = Mexico Central MM = Mexico Mountain MP = Mexico Pacific

5.7 Type overview – flowIQ® 2102 – Chile

				Type	02A-	□□	□	0	□	□	□□
Communication											
915 MHz						36					
Supply											
Battery supply							C				
Meter size											
Q ₃ [m ³ /h]	Connection	Length [mm]	Dynamic range								
2.5	G¾B (R½)	110	1:250						D		
4.0	G1B (R¾)	130	1:250						L		
Meter type											
Cold water meter										8	
Country code											
Language on label etc. (Numbers or letters)											CL

5.8 Type overview – flowIQ® 2103 – Brazil

Type		02C-	□□	□	0	□	□	□□
Communication								
923 MHz, Mode C1			80					
434 MHz, Mode C1			43					
Supply								
Battery supply				C				
Meter size								
Qn [m ³ /h]	Connection	Length [mm]	Dynamic range					
1.0	G ³ / ₄ B (R ¹ / ₂)	115	1:200				R	
1.5	G1B (R ³ / ₄)	115	1:200				U	
1.5	G1B (R ³ / ₄)	190	1:200				E	
2.5	G1B (R ³ / ₄)	130	1:200				L	
2.5	G1B (R ³ / ₄)	190	1:200				N	
Meter type								
Cold water meter							8	
Country code								
Language on label etc. (Numbers or letters)								XX ^{*)}

^{*)} BB = GMT offset -3 BA = GMT offset -4 BF = GMT offset -5

6 Accessories

An overview of suitable accessories are shown in the document: ‘Accessories List 5810-1270’

7 Configuration

7.1 Configuration - MULTICAL® 21 / flowIQ® 2101 / flowIQ® 2102

	KK □□	LLL □□□	MMM □□□	N □	P □	R □	S □	T □
Target date (fixed)	01							
Average time of max values 1-120 minutes (2 minutes default)		002						
Customer label 2005-			MMM					
Leakage message limit OFF				0				
Flow continuously > 0.5% of Q ₃				1				
Flow continuously > 1.0% of Q ₃				2				
Flow continuously > 2.0% of Q ₃				3				
Flow continuously > 0.25% of Q ₃				4*				
Flow continuously > 0.1% of Q ₃				5*				
Pipe burst limit OFF					0			
Flow > 5 % of Q3 for 30 minutes					1			
Flow > 10 % of Q3 for 30 minutes					2			
Flow > 20 % of Q3 for 30 minutes					3			
Optional register in data logger Wired M-Bus						0		
Wireless communication: It is possible to choose different data packages, depending on chosen communication module. <i>For further information – see document 5512-2336</i>						0-9		
Display resolution 00001 m ³							0	
00000.1 m ³							1	
00000.01 m ³							2	
00000.001 m ³							3	
Encryption level No encryption								0
Utility encryption (only available for selected markets)								2
Encryption with separately forwarded key								3
Unless otherwise stated in the order, Kamstrup supplies the following:	01	002	000	1	3	5	3	3

*Only for selected markets

7.2 Configuration - flowIQ® 2103

	KK	LLL	MMM	N	P	R	S	T
	□□	□□□	□□□	□	□	□	□	□
Target date								
(fixed)	01							
Average time of max values								
2 minutes		002						
Customer label								
2005-			MMM					
Leakage message limit								
[l/h] For meter sizes - Qn =		1.5	2.5					
OFF		-	-	0				
Flow continuously > 0.5 % of Qn		8	13	1				
Flow continuously > 1.0 % of Qn		15	25	2				
Flow continuously > 2.0 % of Qn		30	50	3				
Flow continuously > 0.25 % of Qn		3.8	6.3	4				
Flow continuously > 0.1% of Qn		2	3.2	5				
Pipe burst limit								
[l/h] For meter sizes - Qn =		1.5	2.5					
OFF		-	-		0			
Flow > 5 % of Qn for 30 minutes		75	125		1			
Flow > 10 % of Qn for 30 minutes		150	250		2			
Flow > 20 % of Qn for 30 minutes		300	500		3			
Optional register in data logger								
Wireless communication: It is possible to choose different data packages, depending on chosen communication module. For further information – see document 5512-2336						0-9		
Display resolution								
00001 m ³							0	
00000.1 m ³							1	
00000.01 m ³							2	
00000.001 m ³							3	
Encryption level								
No encryption								0
Utility encryption (only available for selected markets)								2
Encryption with separately forwarded key								3
Unless otherwise stated in the order, Kamstrup supplies the following:	01	002	000	1	3	7	3	3

8 Communication

A part of the data sent via the wireless M-Bus signal is optional.

When you select a module, you can select between different protocols (C1, T1) and various reading intervals. Each module provides the opportunity to choose between up to ten different data packages.

You MUST select a data package.

The difference between the module 50 and 41 is only the transmission interval of respectively 96 and 16 seconds. The packages' content is the same.

Please note that the loggers will be reset each time a change of module takes place.

Please also note that the cut-off date is always 31/12, when selecting 'annual reading'.

868 MHz			
	C1	T1 OMS	Radio disabled
Modules with actual values	40/XX*	41/XX*	
Module – 'Radio off'			99/XX*

* For more module choices – see document 5512-2336

8.1 Optional data packages – Wireless M-Bus

The meter has a built-in radio transmitter for Wireless M-Bus Mode C1 or T1 OMS, T1 OMS, BSI and the possibility of configuration of data packages. Consequently, it is one-way transmission. The meter does not include a radio receiver and cannot be contacted via radio.

8.1.1 Transmission

Data packages sent in intervals of approx. 16 or 96 seconds via the built-in antenna. Every eight packages is a 'full string', whereas the seven intervening packages are 'compact strings'.

The time between transmissions depends on whether the meter is configured to 'Drive-by' or 'Fixed network'. This selection is determined when ordering the meter, or it can be configured later by means of METERTOOL. A 'full string' includes extra information on how the meter data are to be interpreted. When a single 'full string' has been received once, the remaining meter population (of identically configured meters), can be read by a 'compact string'. When sending a data package each 16 seconds, the data package is short and compressed to achieve a long battery life.

By 96 seconds intervals, a long and intelligent radio package with built-in 'repair coding' is sent. At the same time, the power of the signal is higher and therefore optimized for use in fixed networks. With the increased interval between the transmissions, the same high battery life is guaranteed.

The table below summarizes and describes the data comprised by the Wireless M-Bus data package:

Data	Explanation
Serial number	The meter's serial number. The serial number will never be encrypted.
Meter specific data	Identification as cold/hot water meter, specific Kamstrup Wireless M-Bus producer-ID. Information on length and format of data package. Information on encryption of data package.
Meter reading	The current meter reading from the meter's legal register
Target volume	Meter reading of the first day of the month or Meter reading of the first day of the year
Max flow	Maximum flow, which has been measured during the year, month or day depending on the selected R- Package
Min. flow	Minimum flow, which has been measured during the year, month or day depending on the selected R- Package
Water temperature	Minimum, max or average water temperature for the last completed year, month or day – depending on the choice of the 'R-package'
Meter temperature	Minimum, maximum or average ambient/meter temperature, latest year, month or 24 hours – depending on choice of 'R'- value
Info codes	Info codes which are active at present
Historical info codes	Info codes which have been active within the latest 30 days including information on how long they have been active – on a scale of 1-7
Reverse volume	The V1 reverse register. Registration of volume of the flow/water running in the wrong direction.
Target date	Date of target volume storage in the monthly log. The date is the last day of the month – i.e. a monthly log created at midnight the night before d. 1/8/2012, will have target date 31/7 2012.
Date/time stamp	Time and date for reading
Battery left	Indicates battery capacity – how many days approx. are left
Radio Disabled	Only module 99 and 98

Module 46: If encryption has been selected, when submitting the order, all variable data will be encrypted with 128 bits AES counter mode encryption.

Kamstrup A/S recommends encryption.

8.2 Wired M-Bus version of flowIQ® 2101

8.2.1 For billing and analysis

- Fixed datagram
- Up to 9600 baud communication speed
- Primary/secondary/enhanced secondary addressing
- According to M-Bus standard EN 13757:2013



8.2.2 Introduction

flowIQ® 2101 is available with wired M-Bus offering easy reading of the water meter via, for example, an M-Bus Master. Also, electricity meters or heat/cool meter with a built-in M-Bus micro-master can be used.

The M-Bus interface fulfills the requirements in the M-Bus standard EN 13757:2013 and can be used in a wide variety of applications using M-Bus protocol.

8.2.3 Applications

The M-Bus meter is designed with focus on high flexibility, to fulfil a wide pallet of applications.

8.2.4 Analysis

flowIQ® 2101 supports high quantities of data in a fixed datagram. This is valid for both actual meter data as well as for historical logger data.

8.2.5 Billing

All relevant data for billing purposes can be read out from flowIQ® 2101.

8.2.6 M-Bus Addressing

The M-Bus interface supports primary, secondary and enhanced secondary addressing.

8.2.7 Primary addressing – (000-250)

When nothing else is specified, the M-Bus interface will automatically use the last 2-3 digits of the flowIQ® 2101 serial number as the primary address.

During the order process or by use of the METERTOOL HCW programming software, dedicated primary addresses can be selected. Further on, the primary address can be changed over the M-Bus network using standardized M-Bus commands.

8.2.8 Secondary addressing – (M-Bus ID No. 00000000-99999999)

The last eight digits of the serial number are used as M-Bus ID number for secondary addressing.

8.2.9 Enhanced Secondary addressing

– (M-Bus ID No. 00000000-99999999)/(M-Bus fabrication No. 00000000-99999999)

Enhanced secondary addressing is supported by adding the meter's serial number as M-Bus Fabrication Number to the secondary address.

8.2.10 Installation

The meter is delivered with a 1.5 m long standard polarity independent connection.

8.2.11 Communication

Communication is in accordance with the M-Bus standard EN 13757:2013

8.2.12 Communication speed

The meter supports 300, 2400 and 9600 baud communication speed and automatically detects the communication speed used by the M-Bus master.

8.2.13 Communication interval

Reading intervals \geq one minute may not reduce the battery lifetime of the meter at any communication speed. Reading intervals \geq 15 seconds are supported, but this will reduce battery lifetime.

8.2.14 Communication via optical read-out head

Apart from the configurations in the flowIQ® 2101 itself, the primary M-Bus address can be configured via the optical readout head and METERTOOL HCW.

8.2.15 Communication from M-Bus master

The following parameters can be configured with M-Bus commands via the connected M-Bus master:

- Primary address
- Meter clock synchronization.

8.2.16 Communication from M-Bus interface

Available data (fixed datagram)

flowIQ® 2101			
M-Bus data header	Actual data	Monthly data ²⁾	Meter data
M-Bus ID	Water meter reading (vol)	Monthly target meter reading	Info codes
Manufacturer ID	Volume reverse	Min. flow last month	Config. number
Version ID	Hour counter	Max flow last month	Meter type (main/sub type)
Device type	Actual flow	Min. temp. water, last month	Meter SW revision
Access counter	Actual temp. water	Avg. temp. water, last month	
Status (info codes)	Actual temp. ambient	Min. temp. ambient last month	
<i>Configuration (not used)</i>	Min. flow day ¹⁾	Max temp. ambient, last month	
	Max flow day ¹⁾	Avg. temp. ambient, last month	
	Min. temp. water, day	Target date	
	Average temp. water, day		
	Min. temp. ambient, day ¹⁾		
	Max temp. ambient, day ¹⁾		
	Avg. temp. ambient, day ¹⁾		
	Date/Time		

¹⁾The daily flow and temperatures are the actual daily minimum, average or maximum values, logged from midnight until the present reading time.

²⁾By 'last month' means the last fully calendar month.

8.2.17 Technical specifications

Physical Fully integrated M-Bus interface

Communication

Readout speed 300/2400/9600 baud with automatically speed detection

Communication interval Longer than 1 minute (recommended)

Protocol EN 13757:2013

Configuration METERTOOL HCW via optical read-out head

Power consumption 1-unit load (1.5 mA) per M-Bus slave

Rin / Cin 422 Ω/0.5 nF

Max cable resistance 29 Ω/180 nF per pair

Operational temperature 5 - 55°C

Markings/approvals - EN 13757CE approval

- MID

Ordering See section '*Type overview*' and '*Configuration*'

9 Data Packages Wireless M-Bus modules

Some of the data transmitted through the Wireless M-Bus radio signal are optional. It is possible to choose between different protocols (C1, T1), and various reading intervals, by choosing a specific module.

For each module there is an option of choosing between up to 10 different data packages. You must choose one data package. (See next page)

Choice of data packages – see document no.: 5512-2336

10 Optional data packages – Sigfox installations

A part of the data transmitted through the Sigfox radio signal is optional. It is also possible to choose between the different data, so it changes from one data package to another. The target volume is mandatory for each transmission, but transmission 1 can have information on max flow, whereas transmission 2 can have information on min flow. This is called 'Sigfox sequence'.

Module	Battery life 16 years	Transmission interval
11	✓	Daily
13	✓	Daily values sequence
97	✓	No transmission – radio disabled

Info codes are displayed once, as soon as the event occurs. If the reason for the info code disappears, and then reappears, the info code is displayed again.

11 Sigfox modules

11.1 Data Packages

R-package	0	1
Info codes	✓	✓
Target volume V1	✓	✓
Max flow target*		✓
Min. flow target*	✓	

* the value is sent daily at target time.

11.2 Sequences

R-package	0	1
Sequence	✓	✓

12 Measurements

12.1 Measurement accuracy

MPE (maximum permissible error range – according to OIML R49)

Kamstrup water meter

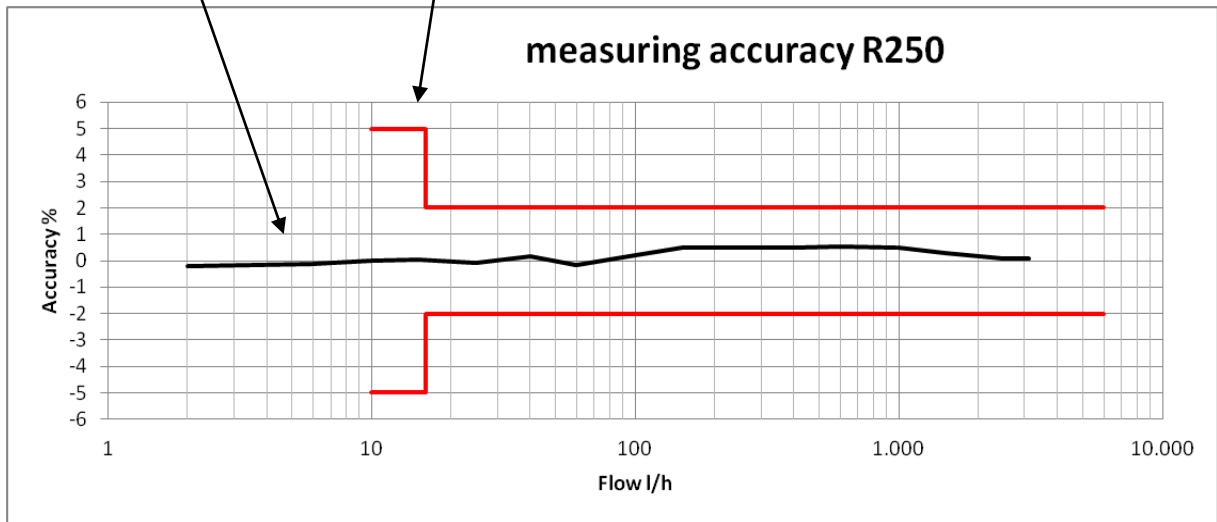

12.1.1 MULTICAL® 21 / flowIQ® 2101 / 2102

MPE according to OIML R49

Meter approved 0.1...30 °C

30...70 °C

MPE (maximum permissible error range) – see figure below.

± 5 % in range $Q_1 \leq Q < Q_2$, ± 2 % in range $Q_2 \leq Q \leq Q_4$

± 5 % in range $Q_1 \leq Q < Q_2$, ± 3 % in range $Q_2 \leq Q \leq Q_4$

S: Start/stop flow

Q_1 : Minimum flow

(Q_3 /Dynamic range)

Q_2 : Transition flow ($1.6 \times Q_1$)

Q_3 : Permanent flow

Q_4 : Overload flow

($1.25 \times Q_3$)

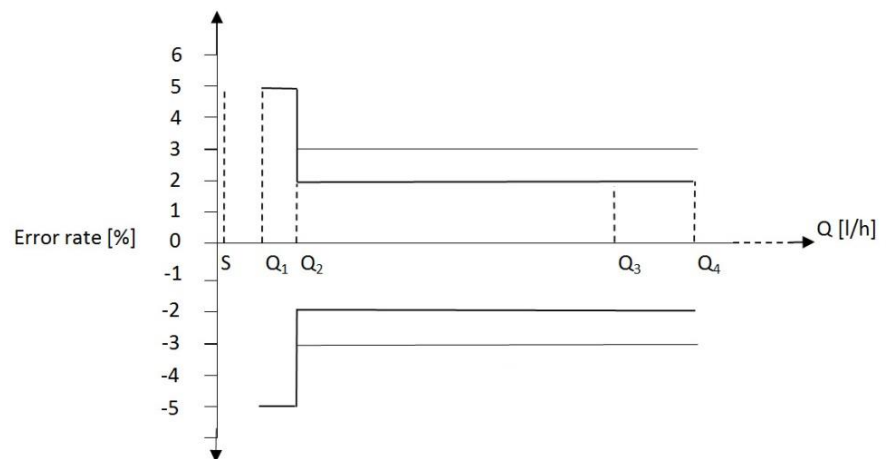

12.1.2 MULTICAL® 21 – RSA (South Africa)

MPE according to SANS 1529

MPE (maximum permissible error range) – see figure below.

Meter approved 0.1...30 °C

± 5 % in range $Q_{min} \leq Q < Q_T$ ± 2 % in range $Q_T \leq Q \leq Q_S$

- S: Start/stop flow
- Q_{min} : Minimum flow
(Q_p /Dynamic range)
- Q_T : Transition flow ($1.6 \times Q_{min}$)
- Q_p : Permanent flow
- Q_S : Overload flow
($2 \times Q_{min}$)

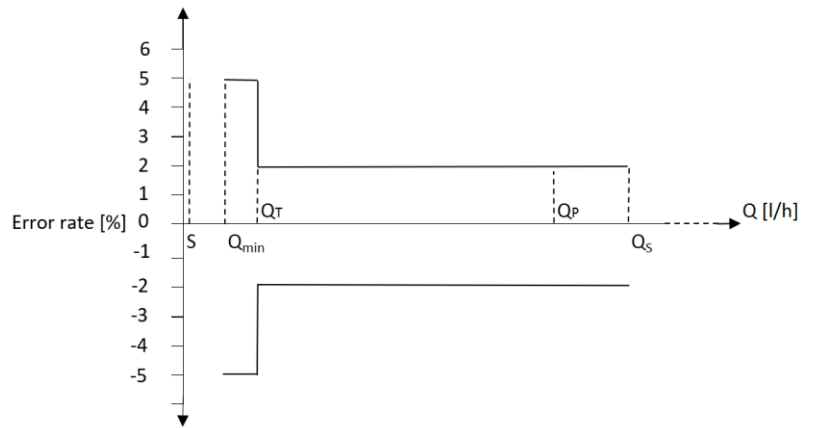

12.1.3 flowIQ® 2103

MPE according to Portaria Inmetro n° 246:2000

MPE (maximum permissible error)

Meter approved 1...40 °C

±5% in range $Q_{min} \leq Q < Q_t$ ±2% in range $Q_t \leq Q \leq Q_{max}$

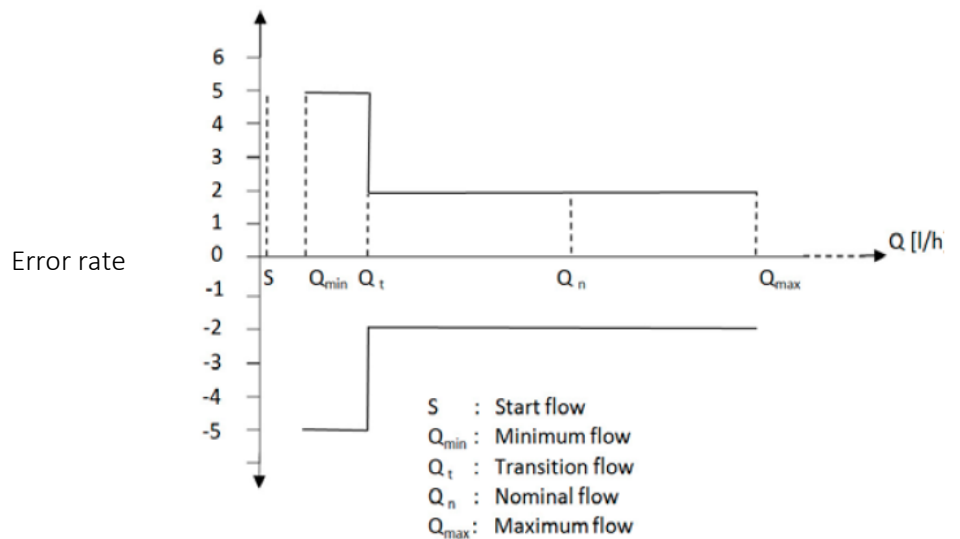

12.2 Temperature measurements

The meter measures ambient and water temperatures – see section '*Temperature monitoring*'

The following accuracies apply to temperature data:

Water temperature:	0 °C – 20°C ± 1 °C
	20 °C – 30°C ± 2.5 °C
	>30 °C – No valid measurement
Ambient/meter temperature:	-5 – 55 °C ± 1 °C
	(Temperature in the meter housing)

13 Measuring principle

13.1 Ultrasound with piezo ceramics

Flow sensor manufacturers have been working on alternative techniques to replace the mechanical principle. Research and development at Kamstrup have proven that ultrasonic measuring is the most viable solution. Based on microprocessor technology and piezo ceramics, ultrasonic measuring is not only accurate but also reliable.

13.2 Principles

Ultrasound signals are sent in the measuring tube from one transducer to another, via reflectors.

The thickness of a piezo ceramic element changes when exposed to an electric field (voltage). When the element is mechanically affected, a corresponding electric charge generates. Therefore, the piezo ceramic element can function as both sender and receiver.

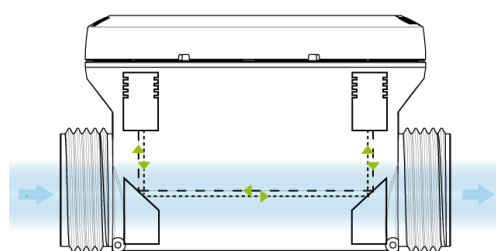

Principle of ultrasound signal path

Within ultrasonic flow measuring there are two main principles: the transit time method and the Doppler method.

The Doppler method bases on the frequency change, which occurs when the sound reflects by a moving particle. This is very similar to the effect you experience when a car passes by. The sound (the frequency) decreases when the car passes by.

13.3 Transit time method

The transit time method used in the water meter, utilizes the fact that it takes an ultrasonic signal sent in the opposite direction of the flow longer to travel from sender to receiver than a signal sent in the same direction as the flow.

The transit time difference in a flow sensor is very small (nanoseconds). Therefore, the time difference is measured as a phase difference between the two 1 MHz sound signals in order to obtain the necessary accuracy.

Illustrated on the diagram below.

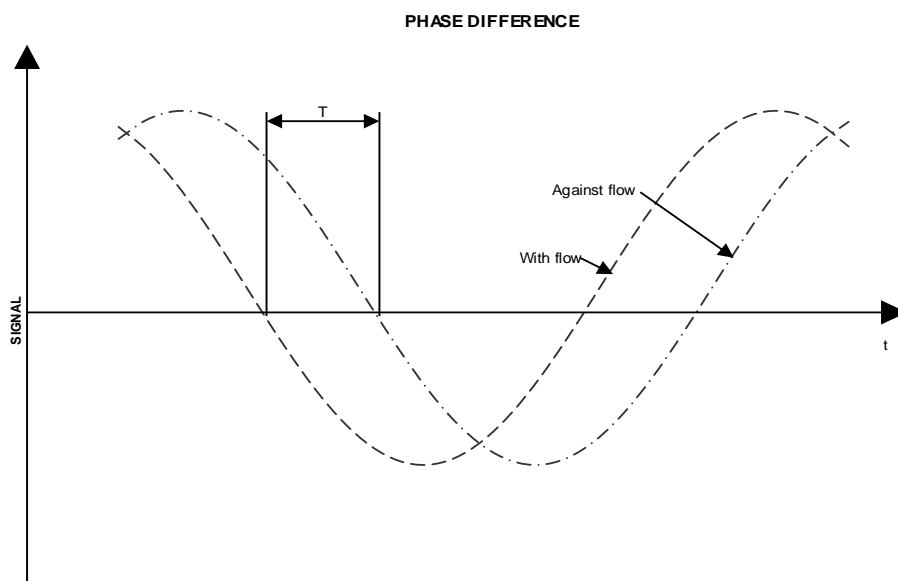

In principle, flow is determined by measuring the flow velocity and multiplying it by the area of the measuring pipe:

$$Q = F \times A \quad \text{where:}$$

Q is the flow

F is the flow velocity

A is the area of the measuring pipe

The area and the length, which the signal travels in the sensor, are well-known factors. The length which the signal travels can be expressed by $L = T \times V$, which can also be written as:

$$T = \frac{L}{V} \quad \text{where:}$$

L is the measuring distance

V is the sound propagation velocity

T is the time

$$\Delta T = L \times \left(\frac{1}{V_1} - \frac{1}{V_2} \right)$$

In connection with ultrasonic flow sensors the velocities V_1 and V_2 can be stated as:

$$V_1 = C - F \quad \text{and} \quad V_2 = C + F \quad \text{respectively}$$

where: C is velocity of sound in water.

Using the above formula, you get:

$$\Delta T = L \times \frac{1}{C - F} - \frac{1}{C + F}$$

which can also be written as:

$$\Delta T = L \times \frac{(C + F) - (C - F)}{(C - F) \times (C + F)}$$

↓

$$\Delta T = L \times \frac{2F}{C^2 - F^2}$$

As $C \gg F$, F^2 can be omitted and the formula reduced as follows:

$$F = \frac{\Delta T \times C^2}{L \times 2}$$

To minimize the influence from variations of the velocity of sound in water, the latter is measured via absolute time measurements between the two transducers. These measurements are subsequently in the built-in ASIC converted into the current velocity of sound, which is used in connection with flow calculations.

13.4 Calculation of flow volume

During flow measuring, the water meter passes through a number of sequences, repeated at fixed intervals. Deviations only occur when the meter is in test mode.

The measurement of the actual velocity of sound in water can also determine the temperature of the water, as there is a correlation between these two values, at temperatures below approx. 30 °C

As mentioned above, the flow calculation is by multiplying the flow rate and the cross-sectional area:

$$Q = F \times A$$

These measurements and calculations are performed every four seconds, in the meter; the calculation itself only takes a few milliseconds. The measurement is therefore a 'snapshot' of the current flow.

This, like any type of digital sampling, integrates the measurements over time, leading to the calculation of the final volume.

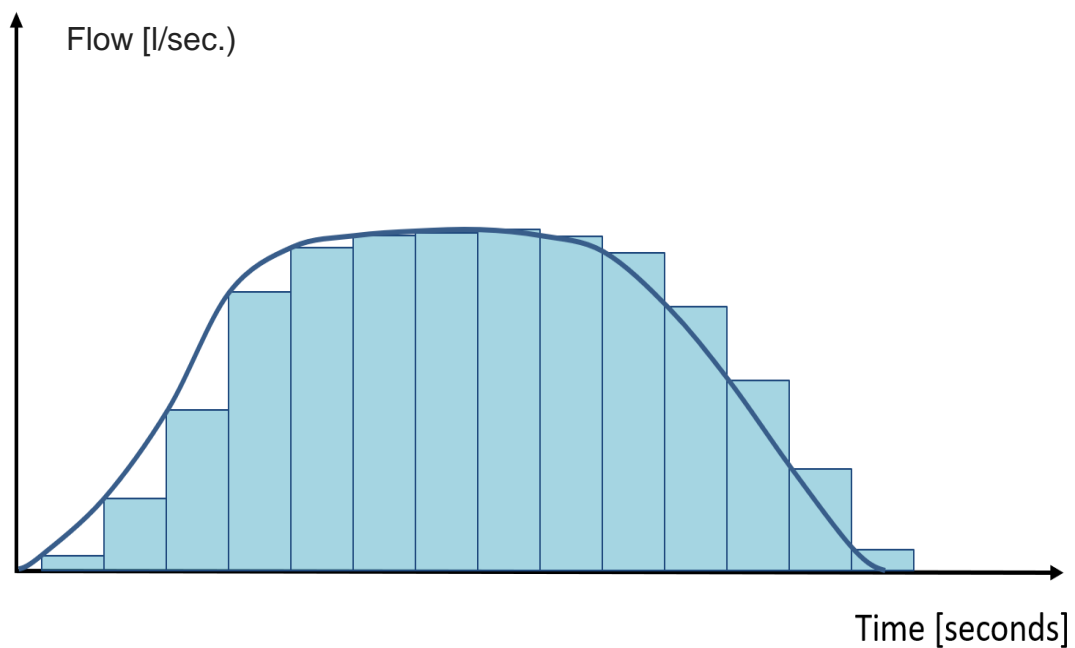

13.5 Flow limits

In the meter's working range, from 'minimum cut-off' to saturation flow (called 'maximum cut-off') the flow through the meter will be registered with an accuracy which reflects legal requirements/OIML R49.

If the flow exceeds maximum cut-off (see tables in section '*Water meter types*'), the water meter registers a constant flow (at 'maximum cut-off'). In practice, the highest possible water flow through the meter will be limited by the pressure in the installation, or by cavitation due to too low downstream pressure.

If the flow value gets lower than 'minimum cut-off', the meter does not register any flow.

In the meter's working range, from 'minimum cut-off' to 'maximum cut-off', there is a linear connection between the quantity of water, which has passed through the meter and the measured water flow.

According to metrological and technical requirements/OIML R49, the upper flow limit (Q_4 /Max flow) is the highest flow at which the flow meter may operate for short periods, without exceeding maximum permissible error. The meter has no functional limitations during the period, when the meter operates above this limit.

Please note, however, that high flow velocities bigger than Q_4 (Max flow) involve the risk of cavitation, especially at low static pressures below 0.03 MPa (0.3 bar) after the meter.

14 Pressure loss

According to OIML R49 maximum pressure loss must not exceed 0.63 bar (0.063 MPa)

in the range Q₁ - Q₃ or (Q_{min} - Q_p. South Africa / Q_{min} - Q_n Brazil)

The pressure loss in a meter increases with the square of the flow and can be stated as:

$$Q = kv \times \sqrt{\Delta p}$$

Where:

Q = volume flow rate [m³/h]

kv = volume flow rate at 1 bar (0.1 MPa) pressure loss

Δp = pressure loss [bar]

14.1 Pressure loss – MULTICAL® 21 / flowIQ® 2101 /2102

Pressure loss table

Graph	Q ₃ [m ³ /h]	Nom. diameter[mm]	K _v	Q at 0.63 bar [m ³ /h]
A	1.6 & 2.5	DN15 & DN20	3.95	3.1
B	4,0	DN20	6.3	5.0

*Republic of South Africa not shown

Pressure loss diagram Δp

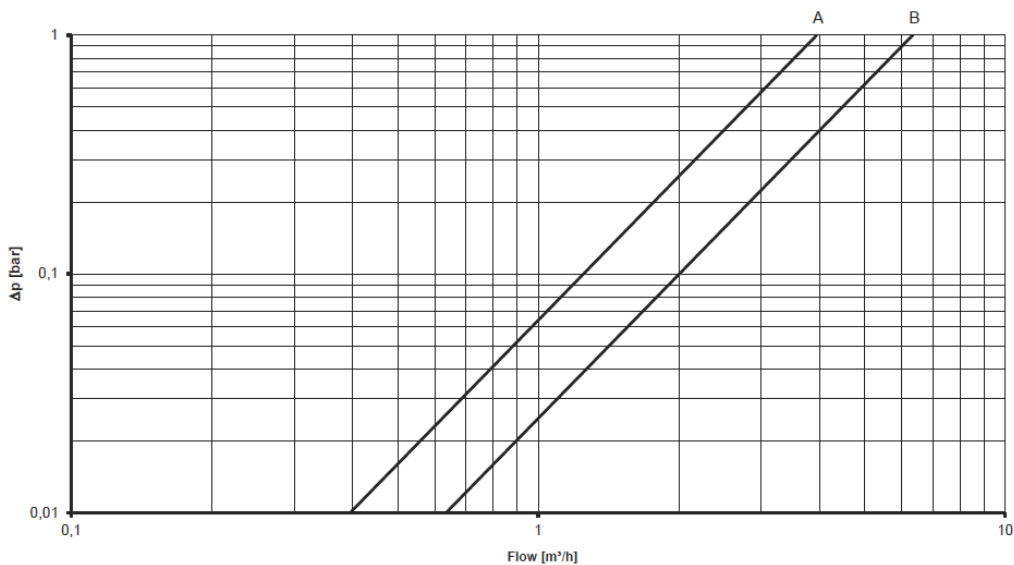

14.2 Pressure loss – flowIQ® 2103 - Brazil

Pressure loss table

Graph	Q _n [m ³ /h]	Nom. diameter[mm]	K _v	Δp at nominal flow Q _n	Δp at max flow Q _{max}
A	1.5	DN20	3.6	0.17	0.70
B	2.5	DN20	6.0	0.18	0.71

Pressure loss diagram Δp

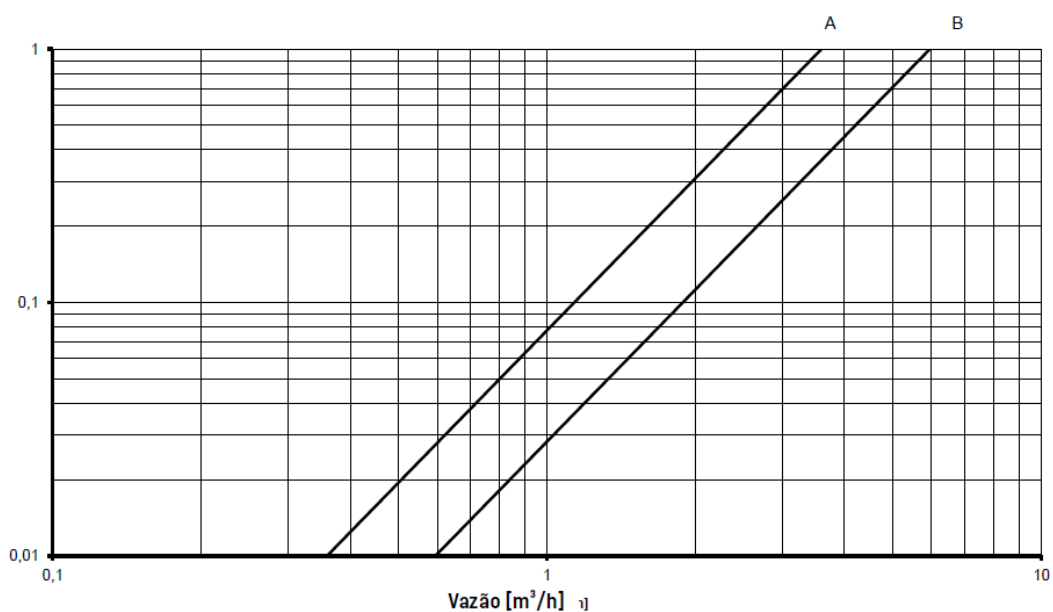

15 Dimensioned Sketches

Type: A / D (B /C) and 1



H (J) and 3

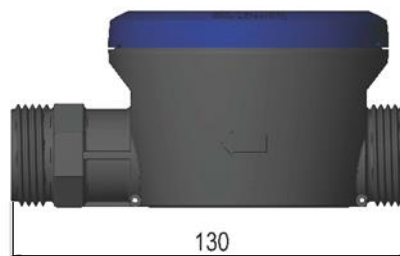

Type: G (F) and 2

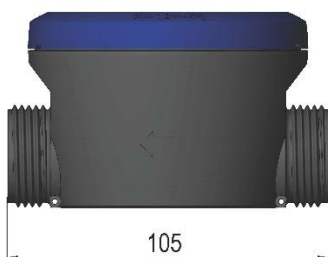

L (M) and 4

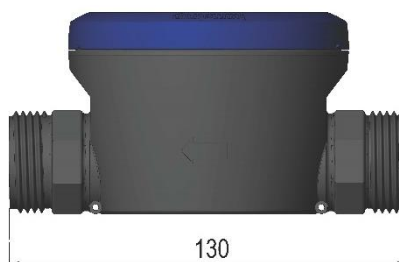

Type U (Brazil)

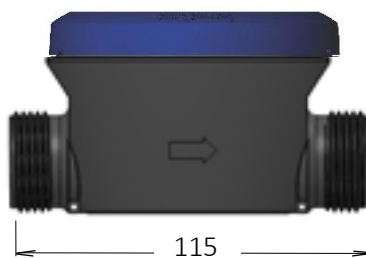

Type: ST U & V (France)

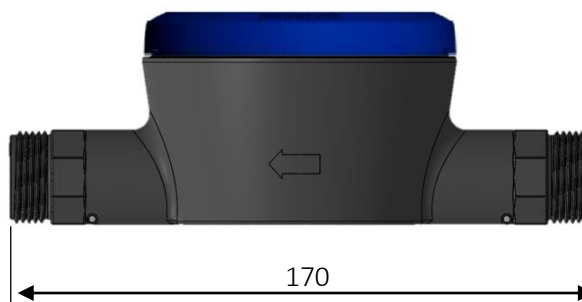

Type E / N (K / P)



Type	A / D (B/C)/1	H (J)/3	G (F)/2	L (M)/4	E / N (K/P)	U	ST / UV
Size	G¾B x 110 mm	G1B x 130 mm	G1B x 105 mm	G1B (R¾) x 130 mm	G1B x 190 mm	G1B x 115 mm	G¾B x170 mm
MULTICAL® 21 flowIQ® 2101 Q ₃ [m³/h]	1.6 / 2.5	2.5	4.0	4.0	2.5 / 4.0		
MULTICAL® 21 (RSA) Q _n [m³/h]	1.5	1.5	1.5	2.5			
MULTICAL® 21 flowIQ® 2101 (France) Q ₃ [m³/h]							1,6 / 2,5
flowIQ® 2102 (AUS) Q ₃ [m³/h]	2.5			4.0	2.5 / 4.0		
flowIQ® 2102 (MX) Q ₃ [m³/h]	2.5	2.5		4.0			
flowIQ® 2103 Q _n [m³/h]				2.5	1.5 / 2.5	1.5	

15.1 Dimensions, connection, weight

See dimensions and weights in the table below:

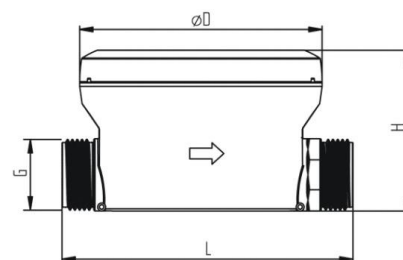

Q ₃ [m ³ /h]	Q _n ^{*)} [m ³ /h]	Meter type	Thread ISO 228-1	L [mm]	H [mm]	D [mm]	Weight approx. [g]
1.6		A	G ^{3/4} B	110	60	91.6	370
1.6		B					
2.5 & 1.5		D/1	G ^{3/4} B	110	60	91.6	370
2.5		C					
2.5 & 1.5		G/2	G1B	105	64	91.6	390
2.5		F					
2.5 & 1.5		H/3	G1B	130	64	91.6	400
2,5		J					
4.0 & 2.5		L/4	G1B	130	66	91.6	400
4,0		M					
--	2.5	L					
2.5		E	G1B	190	64	91.6	455
2.5		K					
--	1.5	E					
4.0		N	G1B	190	66	91.6	470
4.0		P					
--	2.5	N					
1.5 & 2.5		STUV	G ^{3/4} B	170	60	91.6	400
--	1.5	U	G1B	115	64	91.6	395

^{*)} flowIQ® 2103

16 Installation

16.1 Installation requirements

The water meter has built-in data communication, which enables remote reading of the meter.

If installed in pits or basements, the meter must (in some cases) be fitted with an external antenna in order to secure optimum communication. The antenna must be placed outside pit or basement.

Prior to installation of the water meter, the system should be flushed, while a fitting piece replaces the meter. Install the meter. Always use new gaskets in original quality.

Note! Mount the water meter with matching couplings, if needed.

Place the meter as required. The meter can be mounted at any angle however, it should be installed correctly in relation to the flow direction.

Flow direction is indicated by an arrow on the side of the meter housing.

Furthermore, the meter ought to be orientated in a way that the display is easy to read.

(see section '*Installation angle*' and '*Straight inlet*')

When mounting the water meter, you must ensure that the length of the meter thread will not prevent sufficient tightening of the sealing surface, and make sure that PN10 or PN16 connections are used.

Kamstrup A/S recommends EPDM-gaskets for cold water installations and PTFE-gaskets for hot water installations. Kamstrup A/S supplies such gaskets.

See separate accessories list: Doc. no. 5810-1270_GB



16.1.1 Installation conditions

As mentioned above the use of new gaskets in original quality is of crucial importance.

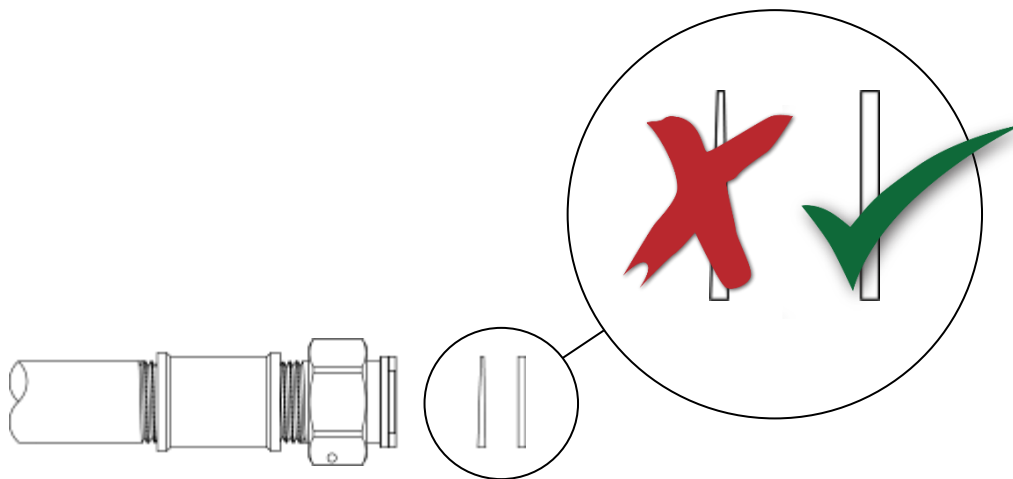
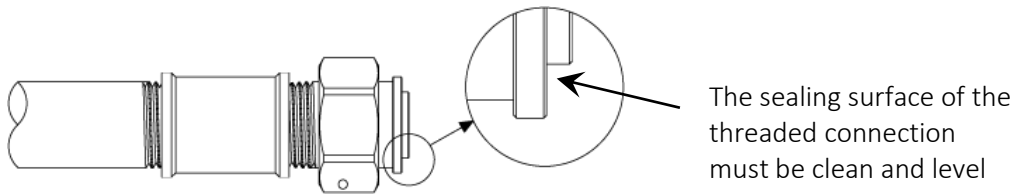

The adjacent pipes must be parallel and fit the meter.

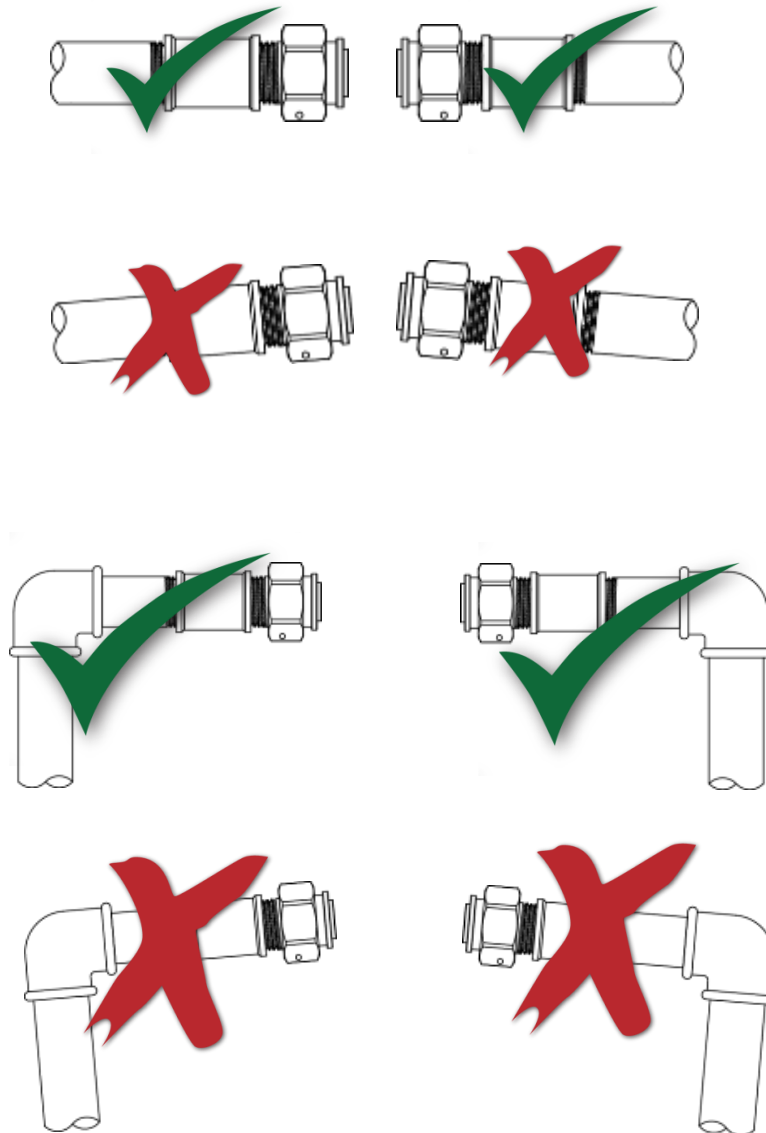

Meter couplings must be tightened with maximum the torque mentioned in the table below:

Meter thread	Min. tightening torque	Max tightening torque
3/4"	7.5 Nm	15 Nm
1"	15 Nm	30 Nm

Skewness of pipes often makes it difficult to obtain a watertight connection, if the above torques must be observed. Furthermore, it can be difficult to estimate the mounting time in advance.

In such cases, Kamstrup A/S recommends installing the meter by means of a special coupling with telescopic function. The coupling can be displaced up to 17 mm – to be able to compensate for differences and inaccuracies of pipe installations, both in the longitudinal direction and, to lesser extent, also against oblique' angles. Kamstrup A/S supplies such couplings.

16.1.2 Permissible operating conditions

Ambient temperature:	2...55 °C – indoors or outdoors. Installation in direct sunlight ought to be avoided.
Temperature of media:	0.1...70 °C
System pressure:	0.3 ...16 bar (depending on couplings/gaskets)

16.1.3 EMC conditions

The water meter is designed for installation in housing and meter pits, as well in commercial and industrial buildings. The meter is CE-marked according to MID based on OIML R49 type test class E1 and E2 for wireless M-Bus version and E1 for Wired M-Bus version, as well as it follows the Low Voltage Directive.

CE-marking applies to Europe only.

16.1.4 Service

When the water meter has been mounted in the system, neither welding nor freezing is allowed. Dismount the meter from the system before starting such work.

In order to facilitate replacement of the meter, closing valves should be mounted on both sides of the meter. Under normal operating conditions no pipe strainer is required in front of the meter.

16.2 Installation angle

The meter can be mounted at all angles and in all positions. Thus, the meter can be mounted in a usual horizontal installation. It can be mounted vertically in an ascending pipe, it can be mounted at any angle and it can be mounted with its display pointing downwards, e.g. under a ceiling. Mounting the meter in a downpipe, you must be aware that the display will in that case be 'upside down'.

16.3 Straight inlet

The meter requires neither straight inlet nor straight outlet to meet the Measuring Instruments Directive (MID) 2014/32/EC and OIML R49:2013. A straight inlet section will only be necessary in case of heavy flow disturbances before the meter.

Regulating valves and pumps cause heavy flow disturbances and large amounts of air in the water, meaning that a shut-off valve, placed immediately in front of the meter, must only be fully open or fully closed. Therefore, flow regulation and pressure reduction must only be done after the meter.

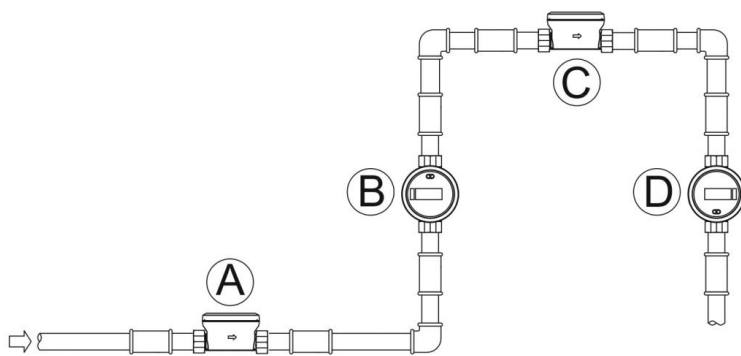

- A** Recommended water meter position
- B** Recommended water meter position
- C** Recommended for well installation.
Air build-up may occur
- D** The meter functions optimally, but the display is 'upside down'

16.4 Operating pressure

In order to avoid formation of air bubbles or vapour in the meter (cavitation) – and to ensure correct measurement under all normal circumstances – the operating pressure in the pipe installation must observe the test conditions of OIML R49, which means that the static pressure downstream, immediately after the meter (the downstream) must always be minimum 0.03 MPa (0.3 bar).

17 Reading and data

17.1 Reading

The meter can be read in three different ways:

- Visual reading of the legal display
- Receiving the Wireless M-bus signal, emitted at intervals of 16 or 96 seconds, depending on the meter configuration, alternatively receiving the wired M-Bus datagram (flowIQ® 2101)
- Reading via the optical eye, e.g. by means of Kamstrup A/S' wireless optical reading head, or optical reading head with USB connector.

17.2 Volume measurement

The meter calculates water flow currently according to a fixed measuring cycle.

When the meter is in normal mode, a measurement is done every four seconds, and after a total of 32 seconds the meter reading is updated in the display. Every 24 hours the meter reading is saved in the daily register. The register includes data for the latest 460 days. The daily register can be read via the optical eye.

The Wireless M-Bus signal: Normally configured to include current meter reading.

The Wired M-Bus signal: Always includes current meter reading.

17.3 Data function: Target volume

The water meter saves the meter reading on the first day of the month (target date) in the target volume register. Data is stored in the monthly register. The register includes data for the latest 36 months.

The Wireless M-Bus signal includes target volume of last month/year if selected during customer specific configuration. The target volume of last month can be selected combined with a number of combinations of water and ambient temperature – see paragraph *'Optional register in data logger'*.

Reading the target volume, is used by waterworks for invoicing and final settlement with the consumer.

The complete register of target volumes for the latest 36 months and/or 10 years can be read by means of the optical eye.

17.4 Data function: Target date

The date in the month for which the meter reading is sent via the radio signal.

17.5 Data function: Reverse Volume

Module 46/66:

Reverse flow is counted and logged in a separate internal register in the meter and can only be read on a monthly basis. If a meter has been incorrectly installed (with reverse flow direction) for a longer period, the reverse volume could be read in the monthly logger. This log is, similar the legal log, an absolute log – which means that the total reverse consumption is shown in the latest monthly log at the end of the month. So even if the fault is corrected, the total reverse consumption cannot be seen until the end of the month. The register can only be read via the optical eye with LogView.

Other modules:

If 'reverse volume' is selected in the R-package the actual REVERSE volume is sent via the radio signal immediately. The total reverse volume is measured and recorded whether the info code is being activated or not. It should be emphasized that the register for backwards volume is NOT covered by the type approval, and therefore not approved for billing purposes.

The legal volume register, V1, and thus the meter reading is not affected by the reverse flow.

17.6 Data function: Date/time stamp

When selected date and time is sent with volume data

17.7 Data function: Battery capacity

Remaining battery capacity according to the selected radio package

17.8 Data function: Radio disabled

'Radio disabled' can be selected from software version T1 and onwards. When radio disabled is selected, the radio will not be activated in normal operation. The only way of enabling the radio is by means of DataTool.

17.9 Data function: Maximum flow and minimum flow

The water meter registers maximum and minimum flow on a daily as well as monthly and yearly basis.
(Depending on which module selected)

Maximum and minimum flows are calculated as the largest and the smallest value, respectively, of a number of current flow measurements. The average period used for all calculations can be selected in the interval 1...120 minutes in leaps of one minute. The choice must be made when submitting the order.

If no choice is made, the average period will by default be 2 minutes.

Wireless M-Bus signal may contain 'maximum flow' for latest day or month, if this is chosen by the customer-specific configuration. Values of maximum and minimum flows are saved in both daily, monthly and yearly registers. Daily registers of the latest 460 days, monthly registers of the latest 36 months and registers of the latest 10 years are always readable via the optical eye.

The development of maximum flow can indicate an error in the water installation. If e.g. max flow falls over a longer period, this can be a sign of a blocking in the installation or a leakage in the supply pipe, before the meter. Maximum flow rate can also be used for an assessment of whether the correct size meter has been installed.

Logging the minimum flow is a valuable information when tracing excessive consumption from temporary leaks.

17.10 Temperature monitoring

The water meter measures water and ambient/meter temperatures, respectively. The measurements can be used to monitor the installation and to give an indication of the quality of water.

Both temperatures are stored in the meter's daily and monthly records.

For each day, temperature values, minimum, maximum and average are stored in the 24 hours' register. The register contains the last 460 days.

Each first day of the month, temperature values, minimum, maximum and average, for the latest month, are stored in monthly register. The register contains the last 36 months. Furthermore, the minimum and maximum values are stored in the yearly register.

Temperature values refer to °C and can be read using the optical eye. The values are sent via the radio signal (or via Wired M-Bus datagram). The temperature values can be combined, as described in section 'Optional register in data logger'.

Optional register in data logger'.

See more about temperature reading accuracy in section '*Measurement accuracy*'.

17.10.1 Temperature monitoring – Ambient/meter

Monitoring the ambient/meter temperature in the installation can be used for warnings of freezing or unintended high temperatures. The measurements, of the meter temperatures, are measured inside the meter housing, which corresponds to the ambient temperature in the environment where the water meter is installed. The temperature is measured every minute.

There are maximum and minimum values based on a 'two-minute averaging value'. The average temperature is a time-weighted mean value.



17.10.2 Temperature monitoring – Water

Monitoring the water temperature can be an indication of quality of the water, when it reaches the consumer. Every 32 seconds, an indirect measurement of the water temperature is made, using the ultrasound signal. The maximum and minimum values are calculated every 2 minutes, based on a volume weighted mean value, since the last minimum/maximum temperature calculation.

Measurement of water temperature requires that the meter is filled with water. If there is no water in the meter, it saves a code, saying that the meter is not water filled.

During periods of very low water consumption, the water temperature approaches the ambient temperature. During periods without water flow the weighted average cannot be calculated, and then a code 128 is stored, indicating that there is no consumption.

17.11 Display functions

The water meter is fitted with an easily readable LCD-display, including eight (8) digits, measuring units, information field with info codes as well as flow indicator (arrows).

The display layout is shown in the figure below.

In the following examples, white/uncoloured segments (see below) indicate inactive segments, whereas black segments indicate active segments.

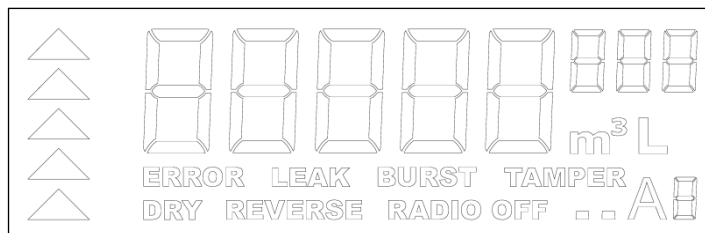

17.11.1 Volume

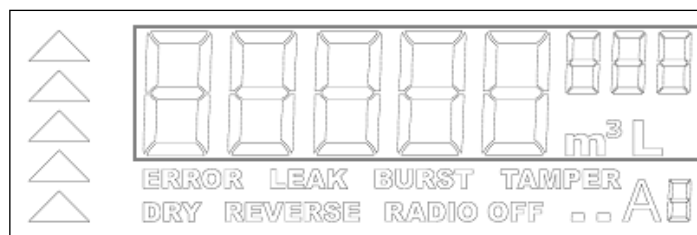

Volume can be displayed in two different units – m³ or L.

Depending on ‘mode’, the legal volume is displayed in the unit [m³] (normal mode) - or the part of the legal volume, which is below 100 m³, in the unit [L] (verification mode). This setting is only used during verification.

The difference in size, between the three small 7-segments furthest to the right and the five large 7-segments furthest to the left, indicates a decimal point; this means that the value that can be shown in the display, and thereby the measured quantity, can be maximum 99,999.999.

The table below shows an overview of modes and readings:

	Normal mode	Verification mode
Data register	V1	V1HighRes
Unit	m³	L
Number of digits	5	5
Decimals after point	0-1-2 or 3	3

Below you see an example of volume reading in normal mode showing V1 = 03,745.214 m³



Below you see an example of volume reading in verification mode showing V1HighRes = 45,214.698 L



17.11.2 Resolution

The resolution of the display can be varied by changing the number of visible decimals after the point. This change has no influence on the measurement itself. The five digits before the point are always on. The number of decimals after the point can be selected by the customer at 0, 1, 2 or 3 decimals when submitting the order, and later with METERTOOL. If no selection is made, the default value of three decimals, after the point, will be used. If the resolution is set at 0, 1 or 2 decimals, the last digit/digits will be removed without round-off.

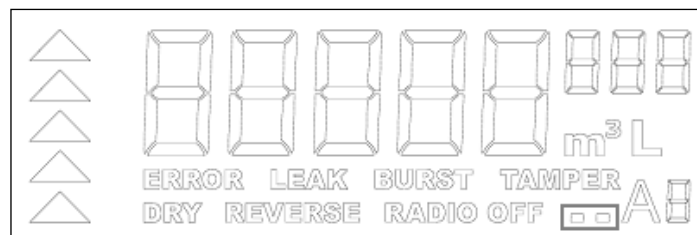

17.11.3 Dots (flashing squares)

The two dots (framed in the above sketch) indicate that the meter is active. They are alternately ON at a frequency determined by the meter's mode. In 'normal mode' they flash once a second. In 'verification mode' they flash twice a second.

Below you see the shift between the two dots:

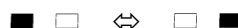

17.12 Info codes

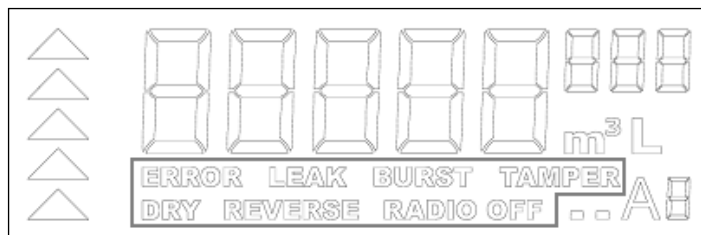

The info codes consist of seven separate text signs (framed in the above sketch), which indicate a special condition in the meter. The signs flash when active. If not, they are 'OFF'. The individual info codes described below:

Info code - ERROR

This info code is not used.

Info code - LEAK

This info code activates if the water in the meter is never stagnant. Possible un-tight connections, running cisterns, un-tight safety valves in hot water tanks, or other leakages will have the result that the meter registers water flow 24 hours a day.

If the water meter has not registered minimum one continuous hour without water flow within the latest 24 hours, this is a sign of a leakage in the water installation. The alarm automatically disappears after an hour without flow in the meter.

The sensitivity of the leak surveillance can be selected by the customer, when submitting the order, and later by METERTOOL. The following options are available:

Leak surveillance	
N=	Constant minimum flow alarm is activated at:
0	OFF
1	Continuous flow > 0.5 % of Q_3/Q_n
2	Continuous flow > 1.0 % of Q_3/Q_n
3	Continuous flow > 2.0 % of Q_3/Q_n
4	Continuous flow > 0.25 % of Q_3/Q_n
5	Continuous flow > 0.1 % of Q_3/Q_n

The utility must be aware that there can be water consumption all the 24 hours in households with many residents. This means that there will not be any hours without flow, and the water meter will set an alarm for this 24-hour period. Users and water utilities must, therefore, be critical of the leakage alarm.

The leakage alarm is saved with a date stamp, in both daily register for 460 days and in monthly register for 36 months. Furthermore, it is saved in the info code register of the latest 50 info code events. Together with the info code event, a time indicator with seven times intervals, which indicates how long the info code has existed, is registered.

The Wireless M-Bus signal includes the LEAK code. If the LEAK code is active, or has been active within the latest 30 days, a time indicator with seven times intervals will indicate how long the info code has been active.

Info code - BURST

This info code activates if the flow exceeds a given value for a continuous period of 30 minutes.

This can be a sign of a burst in the pipe installation, which requires prompt action.

The size of the 30-minute flow (which prompts the info code BURST) can be determined by the customer when submitting the order, and later by METERTOOL. The following options are available:

Bursting surveillance	
P=	Constantly high flow alarm is activated at:
0	OFF
1	Flow > 5 % of Q ₃ /Q _n for 30 minutes
2	Flow > 10 % of Q ₃ /Q _n for 30 minutes
3	Flow > 20 % of Q ₃ /Q _n for 30 minutes

The info code BURST disappears when the flow falls below the above-mentioned limit. It can take up to 64 seconds after the flow has fallen below the above-mentioned limit until the info code disappears. BURST info code is especially suitable for network solutions, as you can respond quickly to sudden leaks.

Utilities must be aware, that water consumption, which activates the pipe BURST alarm of the water meter, may occur in systems with many connected households. Users and water utilities must, therefore, be critical of the burst alarm.

BURST is saved with a date stamp in both the daily register for 460 days and the monthly register for 36 months. Furthermore, it is saved in the info code register of the latest 50 info code events. Together with the info code event a time indicator with seven times intervals, which indicates how long the info code has been active, is registered.

The Wireless M-Bus signal comprises the BURST code. If the BURST code is active, or has been active within the latest 30 days, a time indicator, with seven times intervals, will indicate how long the info code has been active.

Info code - TAMPER

This info code becomes active if the meter has been exposed to unauthorised access, i.e. an attempt to cheat. This means that the meter is no longer valid for billing purposes. The info code TAMPER cannot be removed.

If the info code TAMPER is active, no other info codes can be read via the Wireless M-Bus signal.

Info code – DRY

This info code indicates that there is air in the meter. The ultrasonic measuring principle implies that the meter must be water-filled; the meter does not count air. If there is air in the meter, nothing is measured. The info code DRY activates in the display when eight successive measurements have shown that there is air in the meter, i.e. after minimum 32 seconds and maximum 64 seconds. The code disappears after one measurement without air, i.e. after 4 seconds. If the info code DRY is active, it will immediately appear in the display and from readings via the optical eye.

Note: Air bubbles in the water for short periods may cause the code 'DRY' appears. In order to avoid false alarms due to short-term air build-up in the meter, the info code DRY is not added to the relevant registers, until it has been continuously active for 30 minutes.

DRY is saved with a date stamp in both the daily register for 460 days and the monthly register for 36 months. Furthermore, it is saved in the info code register of the latest 50 info code events. Together with the info code event, a time indicator with seven times intervals (which indicates how long the info code has been active) is registered.

Correspondingly, the info code DRY is not added to the Wireless M-Bus signal, until it has been continuously active for 30 minutes. Furthermore, if the info code DRY has been active within the latest 30 days, a time indicator with seven times intervals indicates in the Wireless M-Bus signal how long the info code has been active.

Info code – REVERSE

This info code indicates that the water in the meter flows in the wrong direction. Info code REVERSE activates when the water runs backwards in the meter at a flow, which numerically exceeds Q_1 for five consecutive minutes. The code disappears from the display when the water is stagnant, or again runs in the correct direction in the meter. It can take up to 64 seconds until the info code disappears.

The alarm REVERSE is saved with a date stamp in both the daily register for 460 days and in the monthly register for 36 months. Furthermore, it is saved in the info code register of the latest 50 info code events. Together with the info code event a time indicator with seven times intervals, which indicates how long the info code has been active, is registered.

The Wireless M-Bus signal includes the code REVERSE. If the code REVERSE is active or has been active within the latest 30 days, a time indicator with seven times intervals will indicate how long the info code has been active.

Info code – RADIO OFF (transport mode)

This info code is active and flashes in the display when the water meter leaves Kamstrup A/S, and indicates, that the meter is still in ‘transport mode’ and that the built-in Wireless M-Bus radio transmitter has not yet been activated.

In ‘transport mode’, the meter displays info codes, if any. These are not logged into the corresponding registers and are not added to the corresponding hour counters.

The Wireless M-Bus radio transmitter activates, when water starts flowing and the meter has registered approx. 0.5 litre of water. The radio transmitter remains active.

The info code RADIO OFF is an info code signal, which either flashes or is inactive. When RADIO OFF flashes in the display, the radio is off. When the RADIO OFF signal is inactive in the display, the Wireless M-Bus radio transmitter is on.

The info code is a ‘display code’ which is not included in the Wireless M-Bus signal.

17.12.1 Adjustment mark

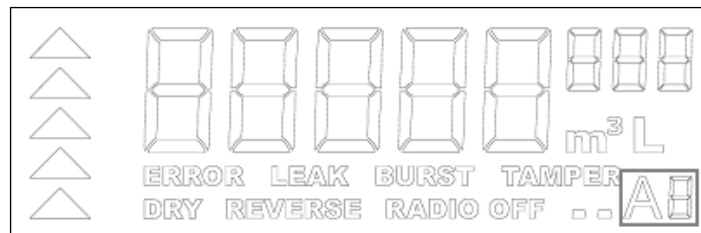

The symbol ‘A’ and the corresponding figure indicate the number of flow adjustments and legal changes after factory verification. For further description, see paragraph ‘

Legal changes outside seal’.

It is possible to reset the legal registers and change the factory programmed flow curve to a limited extent. The flow adjustment makes it possible to adjust the existing curve at three points. The total adjustment compared to the factory adjustment cannot exceed +/- 10 %.

As long as no adjustments have been made, both the ‘A’ and the digit are inactive, and Kamstrup A/S does not add further adjustment marking to the meter. After the first adjustment, ‘A’ activates, and the digit shows the number of adjustments (1 to 9). Below you see the sequence from adjustments 1 to 9.



17.12.2 Flow arrows

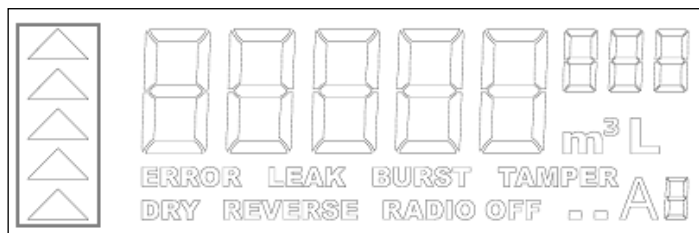

The flow arrows in the left side of the display indicate whether water flows through the meter (in the right direction). If there is no flow (or backwards flow), all arrows are OFF. If there is flow through the meter, the following sequence runs with a timing of 0.5 seconds per reading.

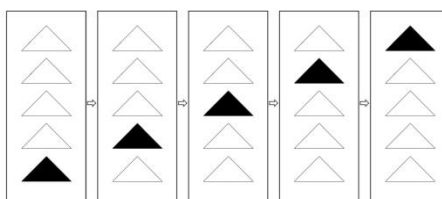

17.13 Optical eye

The meter is fitted with an optical eye that gives access to the meter's external interface, with which all the meter's data registers can be read. For instance, data can be read, using Kamstrup's optical reading head. The reading head includes a permanent magnet, which switches on the optical eye. The interface communicates at 1200 baud.

In order to limit current consumption, the default setting of the optical eye is OFF.

By means of a magnet sensor the optical eye will automatically switch ON, if an optical reading unit with magnet is placed on the meter. The start-up time of the optical eye (from the magnet is attached to the meter until the optical eye switches on) depends on the meter's mode as shown in the table below.

Normal mode	4 sec.
Verification mode	0.5 sec.

Note! Water meters are no longer polarity neutral when detecting the optical eye; that means the optical eye magnet must be orientated right, otherwise the optical interface will not be activated.

This applies to the following versions:

- wMBus from SW revision V1
- Sigfox

For Kamstrup's optical reading head a holder is available, which fits the water meter, and clicked onto the meter.



18 Data loggers

18.1 Memory

The meter has a permanent memory (EEPROM), in which the values of various data loggers are saved.

Loggers are read through the optical eye.

The meter includes the following registers:

Data logging interval	Data logging depth ^{*)}	Logged value
Yearly logger	10 years	Counter register
Monthly logger	36 months	Counter register
Daily logger	460 days	Counter register
Info logger	50 events	Info code, meter reading and date

**)On specific modules the logger is disabled – see which ones in document no.: 5512-2336*

The loggers are static ones. Thus, the register types cannot be changed. The same applies to the logging intervals. When there is no more space in logger (EEPROM), the newest logging will overwrite the oldest log.

18.2 Yearly, monthly and daily loggers

The table below, showing which registers logged on the first day of the month/year, and which registers logged every day. The logger is an absolute log, i.e. current meter reading, logged every day.

Register type	Description	Yearly logger 10 years	Monthly logger 36 months	Daily logger 460 days
Date (YY.MM.DD)	Logging time, year, month and day	✓	✓	✓
Volume V1	Current meter reading (legal)	✓	✓	✓
Operating hour counter	Accumulated number of operating hours	✓	✓	✓
Info	Info code	–	✓	✓
Vol Reverse	Volume during reverse flow	✓	✓	–
Date for max flow	Date stamp of max flow during period	✓	✓	–
Max flow V1	Value for max flow during period	✓	✓	✓
Date for min. flow V1	Date stamp of min. flow during period	✓	✓	–
Min. flow V1	Value of min. flow during period	✓	✓	✓
Min water temp.	The lowest measured water temperature during period	✓	✓	✓
Average water temp.	Volume weighted average water temperature during period	✓	✓	✓
Max water temp.	The highest measured water temperature during period	–	✓	✓
Min. ambient/meter temp.	The lowest measured ambient temperature during period	✓	✓	✓
Average ambient/meter temp.	Time weighted average ambient temperature during period	✓	✓	✓
Max ambient/meter temp.	The highest measured ambient temperature during period	–	✓	✓

Every time an info code changes, date and code are logged. Thus, it is possible to read the last 50 changes of the information codes and date of the change. The reading is only possible via the optical eye.

For the following modules: 60, 61, 62, 63, 64, 65, 99 the daily, monthly and yearly loggers are not accessible from the optical eye, which is why the values in the loggers will be 0 (showing a 0).

18.3 Optional register in data logger

Some of the data sent via the radio signal is optional. It is possible to select one of the data packages with content as listed in table in sections '*Optional data packages – Wireless M-Bus*' or '*Optional data packages – Sigfox installations*'

The choices are determined by means of the selected R-value when ordering a water meter.

Note! R-value 1 + 2 are not an option for flowIQ® 2103

See description of Wireless M-Bus signal in section '*Data communication*'

18.4 Loggers

Configuration options as shown below:

Function	DataTool (licensed)	METER TOOL	LogView	LabTool (licensed)
Logger depth settings	✓			
RF enable/disable	✓			
Communication module ID change	✓			
Data packet settings	✓	✓		
Logger readout			✓	

18.5 DataTool

With DataTool the water supply company has the option to change various settings in the water meters that are connected to the customer number. After DataTool has been installed on the computer, the supply company can choose between different modules and communication standards.

If the meter for example is purchased with module 40, it can be reconfigured to match one of the other modules. In addition to this, the radio can be turned off when needed. Already during the ordering process the desired setting is considered. Data Tool can be obtained from Kamstrup by sending an e-mail to service@kamstrup.com

Module	Battery lifetime		
	16 years	12 years	10 years
40	✓		
41		✓	
42			✓
48			✓

Transmission intervals:

Fixed Network: 96 seconds
 Drive-by solution: 16 seconds

* Detailed information about modules and battery lifetime – see document: 5512-2336

With a licensed configuration tool, 'DataTool', you can re-configure the desired parameters (modules and data packets) not available for METERTOOL etc. via optical eye.

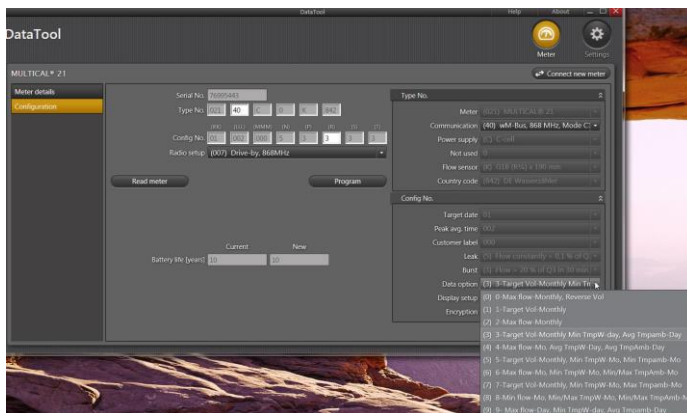

An existing log will always be deleted when configuration is changed.
 Modules **60-65** (without logging) can be re-configured to **40-42** (with logging)

18.6 Hour counter

Each info code, DRY, REVERSE, LEAK and BURST, has a corresponding hour counter. The hour counters are incremented by one every hour, counted on the meter's clock, the corresponding info code is active.

Counting starts immediately the first time the info code is active within the hour in question. Even though the info code occurs more than once, within an hour, the counter is only incremented once. If the info code remains active for several hours, the counter is incremented by one for each hour. The increment is independent of how small a part of the hour the info code is active.

Please note: The info code 'DRY' is set in two steps, the increment of the hour counter follows the second step. See paragraph 'Info codes'

The hour counters cannot be accessed directly but are represented in the info register in coarse resolution. See paragraph 'Info register'

No hours will be counted while the meter is in 'transport mode'.

18.7 Info register

Every time the information code has changed, date and info code are logged. Thus, it is possible to data read the latest 50 changes of the information code as well as the date the change was made. Reading is only possible via the optical eye. The table below represents an overview of the register.

Register type	Description	50 shifts
Date (YY.MM.DD)	Logging time, year, month and day	✓
Volume	Meter reading	–
Info	Information code on above date	✓

The info codes and info code hour counters are set together in one register for presentation in loggers, the Wireless M-Bus information package and read-outs via the optical eye. The information has been compacted in order to reduce the quantity of data in the Wireless M-Bus package and partly also in the loggers.

The register size is 2 bytes, apportioned with 4 bits for info codes and 12 bits for the info code hour counters. The distribution shown below – the numbering shows the bit position.

Byte 123 – meter size ≤ 4 m ³ /h Byte 104 – meter size > 4 m ³ /h								Byte 122 – meter size ≤ 4 m ³ /h Byte 103 – meter size > 4 m ³ /h							
15	14	13	12	11	10	9	8	7	6	5	4	3	2	1	0
Info code hour counters												Info codes			

The first 4 bits for info codes represent DRY, REVERSE, LEAK and BURST as shown below. The info code is active when the bit value is 1.

In the Wireless M-Bus package, in the info logger and in read-outs of the current info register via the optical eye, the current status of the info codes is shown. (also see different update of DRY, in paragraph 'Info codes'). The daily and monthly loggers show all info codes, which have been active since the latest logging.

3	2	1	0
BURST	LEAK	REVERSE	DRY

The hour counters (for the four info codes), are represented by the last 12 bits apportioned with 3 bits each, as shown below.

15	14	13	12	11	10	9	8	7	6	5	4
BURST			LEAK			REVERSE			DRY		

Every time an info code has been active it is logged, together with an indication of how long the info code has been active.

The time indication informs with coarse resolution, how many hours the corresponding info code has been active within the latest 30 +1 days, i.e. the latest 30 days + current day.

Below, please find interval limits and corresponding intervals.

Interval	Hours
0	0 hours
1	1-8 hours
2	9-24 hours = 1 day and night
3	25-72 hours = 2-3 days and nights
4	73-168 hours = 4-7 days and nights
5	169-336 hours= 8-14 days and nights
6	337-504 hours = 15-21 days and nights
7	≥ 505 hours = 22-31 days and nights

Example: By means of LogView or by exporting a reading from Wireless M-Bus Meter Reader to Excel the decimal value 14396 has been read. The value is converted to binary digits, and leading zeroes are added to reach a total, of 16 characters. This makes:

001 110 000 011 1100

these digits into the above table makes:

15	14	13	12	11	10	9	8	7	6	5	4	3	2	1	0
001			110			000			011			1	1	0	0

As mentioned above the first four fields with the figures 0-3 indicate whether the info codes are active, and it thus appears that LEAK and BURST are currently active.

The binary values of the remaining fields must now be converted into decimal values, which indicates how long the corresponding info code has been active, within the latest 31 days according to the above table. It appears that BURST has been active for 1-8 hours and LEAK has been active for between 15 and 21 days. Furthermore, DRY has been active for 2-3 days within the latest 31 days.

18.8 Meter modes (settings)

The water meter has two 'modes':

Meter mode:	Normal	Verification
Measuring cycle (measurement/calculation)	4 s/32 s	0.5 s /4 s
Display value	[m ³]	[L]
Display dots, frequency	1 Hz	2 Hz
Mode, time out	No	Yes

Verification mode is only used by authorised laboratories during verification.

18.9 Normal mode

Normal mode is meant for normal operation.

In normal mode, the volume unit symbol m³ displays. Furthermore, the two squares ('dots') at the bottom right of the display shift every second.

The flow is measured every four seconds and new values (flow, volume, etc.) are calculated every 32 seconds.

18.10 Verification mode

Verification mode is meant for verification of the meter.

In the display, verification mode will be indicated by the volume unit symbol 'L'. In addition, the two dots at the bottom right of the display are changing twice per second.

The flow is measured twice a second and new values (flow, volume, etc.) are calculated every four seconds.

When the meter switches to 'verification mode', the wireless M-Bus radio transmitter turns off. At the same time, a time-out starts. When the time-out period has expired the meter switches back to normal mode. The time-out period is 9 hours.

18.11 Legal changes outside seal

This paragraph describes the legal changes, carried out without disassembling the meter, and thereby breaking the legal seal.

All legal changes are fully traceable in an adjust log, which cannot be deleted. The number of legal changes appears from the display (see paragraph 'Adjustment mark'). Maximum nine changes are possible.

The adjust log can only be deleted if the meter is disassembled and the legal seal is broken. It appears from the meter's software version, whether a specific meter can be reset outside the legal seal.

See support of legal changes in table below:

SW revision	Re-adjustment	Reset
A1		
B1 – F1	✓	
G1→	✓	✓

✓ = supported

18.11.1 Flow adjustment

The meter is initially verified from factory. A new factory adjustment requires disassembling of the meter, and only be carried out by Kamstrup A/S. When the meter has locked, it is only possible to make a percentage correction of the flow curve at three individual points – called a re-adjustment.

18.11.2 Re-adjustment

A re-adjustment can be made without disassembling the meter and thereby breaking the legal seal. The following restrictions apply:

- Maximum 9 (nine) re-adjustments are possible.
- Maximum adjustment compared to the factory adjustment is +/-10%.
- Each readjustment is logged in the meter.

During re-adjustment, the flow curve corrects, at three fixed points, and the curve will be re-adjusted to these new points.

IMPORTANT: The laboratory, which makes the re-adjustment, must attach an adjustment label with the valid adjustment number to the meter. Naturally, this number must be identical with the number (AX) in the meter's display.

18.11.3 Reset

The meter ‘reset’ is possible via the optical eye – used in connection with re-verification by authorized laboratories. All loggers and registers, including the legal volume register, will be ‘reset’. Only the adjust log and the clock are not reset. At the same time, the meter is set to transport mode and the radio switches off.

The following restrictions apply to reset:

- The meter can be reset maximum 9 times.
- Each 'reset' is logged in the meter.

IMPORTANT: The laboratory, which resets the meter, must attach an adjustment label with the valid adjustment number to the meter. Naturally, this number must be identical with the number (AX) in the meter’s display.

Below, samples on:

Re-verification label

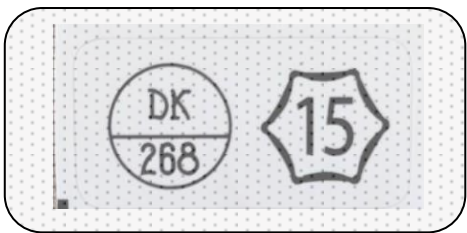

Label used at control testing
(meter not approved for re-verification)



19 Pulse adapter for MULTICAL® 21 / flowIQ® 2101/..02/..03

The Pulse Adapter is a stand-alone unit, designed to be mount on the water meter.
(for wireless meter versions only)

The unit must be mounted indoors in utility rooms or similar.

The Pulse Adapter receives optical pulses from the water meter and transmits them to external data acquisition or control systems through a wired pulse output.



Pulse Adapter type 66-99-021

- here shown mounted on the water meter

19.1 Function

Pulse output:

- 'Open Collector' (2-wire connection)
- Pulse duration 100ms
- Resolution 0.1 pulses/litre (1 pulse/10liters)
 - Cable type: length approx. 1.5 m – sleeves on cable ends
 - Permitted cable length in total, maximum 30 meters
 - Max power 200 mA

The Pulse Adapter can be used for MULTICAL® 21 / *flowIQ® 2101/..02/..03 – SW revision H1 and forward.

**Not for wired version of flowIQ® 2101*

19.2 Application – environment

- Ambient temperature: 2 °C...55 °C
- Storage temperature: -25 °C...60 °C
- Protection class: IP65

19.3 Lifetime - Pulse Adapter

- 16 years, with a single AA battery
- Battery change is possible

19.4 Connection of Pulse Adapter

From the factory, the meter is configured not to transmit optical pulses – otherwise, battery life will be shortened. Therefore, having mounted the Pulse Adapter, the installer must set up the meter to transmit optical pulses.

The procedure is as follows:

1. Unfasten the screw of the adapter ring to allow mounting of the unit on the meter
2. Dismount the two screws at the top and remove the cover
3. Push the button on the PCB, which is placed under the cover (see figure below)

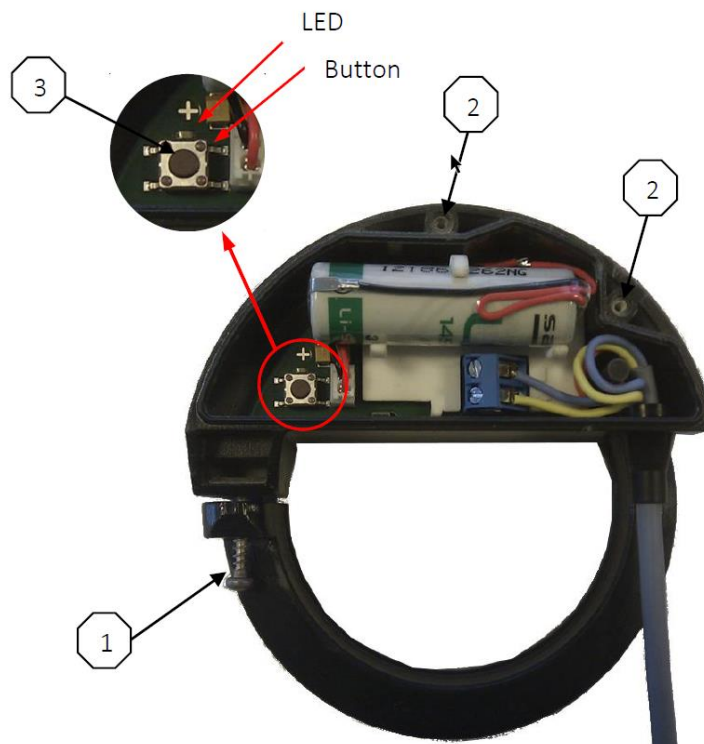

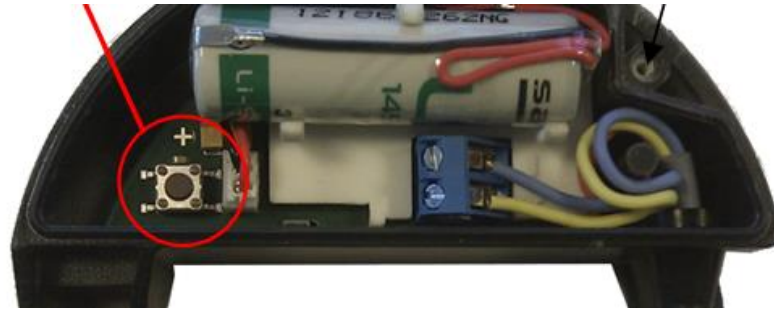

As soon as the button is pushed, serial optical communication between Pulse Adapter and meter starts.

If the setup is successful, 'PULSE ON' displays for five seconds (as shown below) and the LED on the unit remains 'on' for three seconds – shown in the figure below.

It takes only a very short time from setup starts until it is completed.



Display, after set-up

Having set up the meter, remount the cover on the Pulse Adapter and fasten the three screws.

19.5 Pull-up

The acquisition unit must have built-in 'pull-up' – shown in figure below – to ensure correct voltage level of the pulse. The pulse output is two-wired and must be connected as follows:

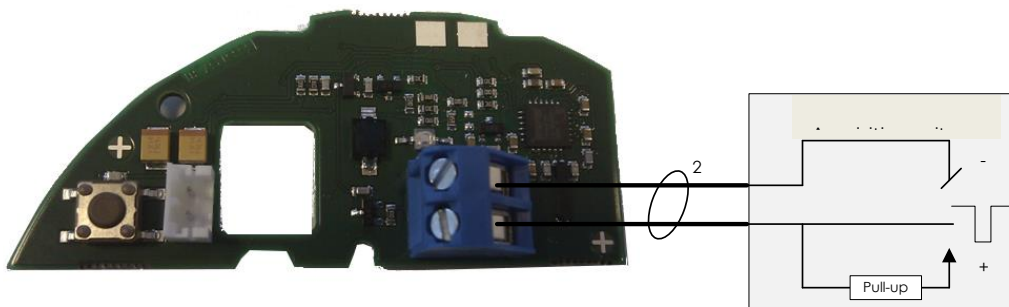

Sketch for connection of Pulse Adapter

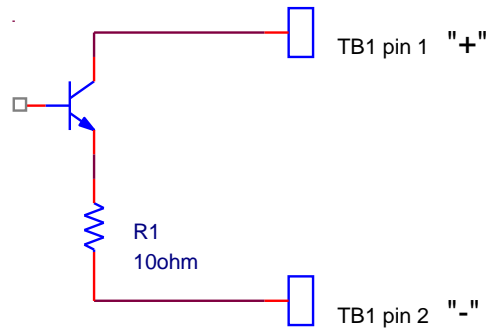

Simplified diagram for Pulse Adapter output

19.5.1 Description

Pulse output:	
Type	Open Drain
Maximum input voltage	30V
Maximum current sink	27mA
On voltage	Vout < 0.3V @ 0.1mA current Vout < 2V @ 27mA current
OFF condition	R > 6Mohm

The connection marked '-' must be connected to the receiver's GND level.
 The connection marked '+' must be connected to a pull-up resistor of an appropriate size.

Thereby, the maximum limits, shown in the table above are met.

20 Pulse Interface for MULTICAL® 21 / flowIQ® 2101 / ..02 / ..03

To bring the meters into a diagnostic test mode, and during calibration and verification in test stands with pulse interface, the Pulse Interface, type 66-99-143, is used.

The optical reading head is retained on the meter, by means of a transparent plastic holder

Optical support, type 6561-331 – for Wireless meters

Optical holder type 3026-867 – for wired M-Bus meters

Data from the water meter is read by the optical reading head and are converted in the pulse interface unit into high-resolution volume pulses, which can be registered by a pulse receiver. When the optical reading head is removed it takes 9 hours before the meter returns to normal mode.



Pulse Interface, type 66-99-143, with Optical Support type 6561-331 on flowIQ® wireless



Pulse Interface, type 66-99-143, with Optical Holder type 3026-867 on flowIQ® wired

Supply: 3.5-30 VDC < 15 mA
 Standby: < 0.2 mA
 Pulse width: = 3.9ms
 Frequency: Max frequency of 128 Hz

Meter size	Volume
Q3 [m ³ /h]	[Pulses/litre]
1.6	100

2.5	100
4.0	50

20.1 Connection Pulse Interface

The pulse interface has two outputs – ‘Volume’ and ‘Energy’. The water meter only uses the volume output.

Each pulse output consists of three terminals: ‘GND’, ‘Volume Pulse’ and ‘Pull-up Volume’. When the pulse output is active, Pulse is drawn to GND, i.e. the output is ‘active low.’ A 10kΩ resistance is placed from Pull-Up to Pulse.

The supply for terminals 1 and 2 and the supply connected to the Pull-Up do not need to be the same or at the same level. The connection of the 8-pole plug J1, shown in figures below/next page.

20.1.1 Connection with pulse receiver without supply

Here external supply for Pull-up is required

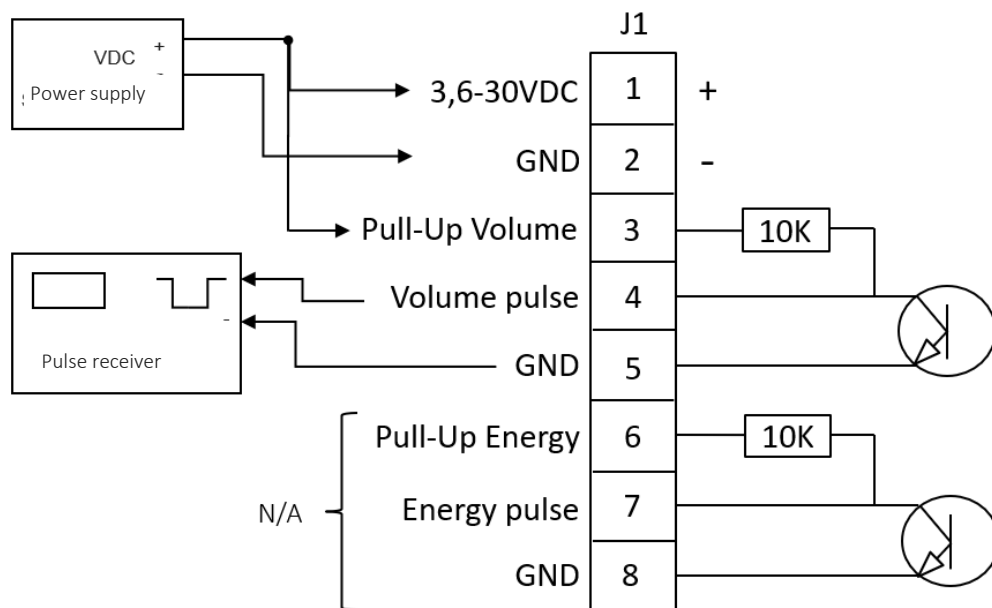

20.1.2 Connection with pulse receiver with supply

Here can the supply from the receiver be used.

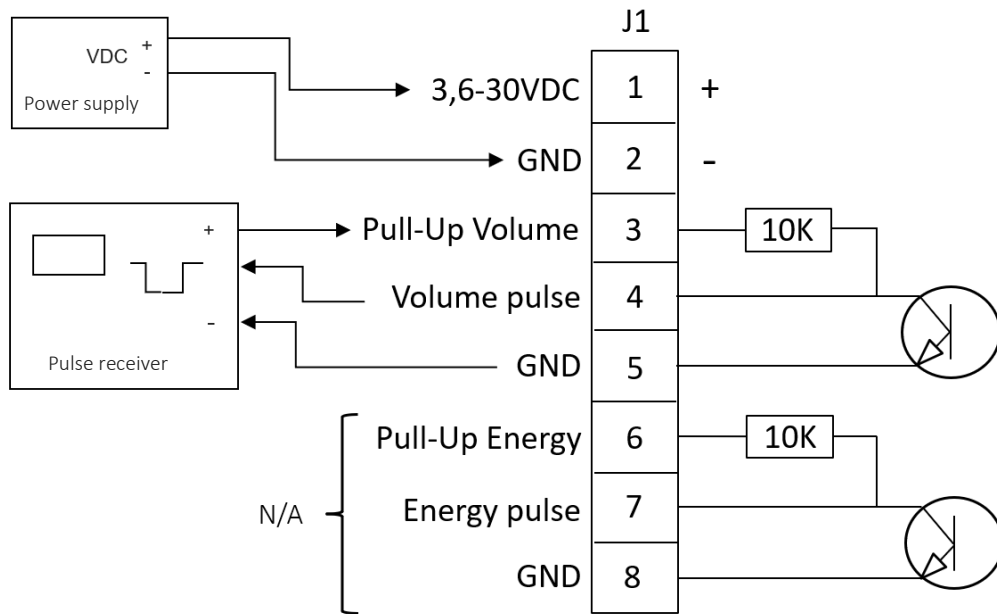

21 Data communication

The meter has built-in radio for Wireless M-Bus Mode C1 or T1 OMS or for Sigfox.
 Note! It is one-way data transmission *from* the meter – no data receipt in meter.

21.1 Transmission

Wireless M-Bus data packages are sent at intervals of approx. 16 or 96 seconds. Every eighth package is a full data string, whereas the seven intervening packages are compact data strings.
 Sigfox data packages are sent daily.

The nominal transmission power is:
 Drive-by mode: 10 MW
 Fixed Network: 25 MW
 IoT/Sigfox: 19 MW

Note! The content of the data package is updated at every transmission.

21.2 RADIO OFF

Radio transmission interrupts if 'RADIO OFF' displays.

RADIO OFF activates at the end of the production process at Kamstrup. The meter removes RADIO OFF automatically, when the volume register has counted water consumption for approx. 5 seconds.

RADIO OFF is intended for situations where radio transmission is inappropriate – e.g. in laboratories, in warehouses and during air transport, where many meters will typically be concentrated in one place.

It is not possible to stop the radio transmission of a meter in normal operation permanently, but the meter can be turned OFF by means of the optical eye e.g. in advance of air transport. However, the radio will automatically turn ON again, as soon as a water flow is registered.

RADIO OFF secures that the meter does not send radio communication until the meter is set into operation for the first time.

21.3 Data Content

The data package in the data transmission partly depends on the communication module configuration, chosen when ordering the meter.

Some reconfiguration of the data package and change of the communication module can be done afterwards, with the software program 'Datatool'

Module number in the configuration is: 021-~~XX~~-XX-X-X

Details and information about data packages and communication modules are available on Kamstrup web page.

21.4 Encryption

The water meter can be ordered without or with encryption^{*)} of data transmission. If encryption of data is selected, it consists of 128 bits AES counter mode encryption. Kamstrup A/S recommends encryption

**) Meters produced for Russia will always be WITHOUT encryption.*

21.5 Radio disabled

Choosing module **99** and **98** (868/434 MHz) or module **97** (IoT/Sigfox), the Radio communication is disabled. Radio OFF sign will be present in the display (not flashing). The radio can be activated with DataTool.

22 Communication (KMP)

The meter has an optical communication interface on the front. The interface communicates at 1200 baud and can be used if an optical reading head is connected to METERTOOL and LogView.

22.1 Optical eye activation

In order to limit current consumption, the optical eye is usually, switched off. The meter's optical communication is automatically, switched on 4 sec. after having placed the magnetic optical reading head on the meter.

23 METERTOOL for MULTICAL® 21 / flowIQ® 2101 / ..02 / ..03

METERTOOL is a PC-program – giving access to change the customer selected parameters of a water meter configuration and read its data memory without dismounting the meter from the installation.

Get further information and technical details on METERTOOL/LogView in the document:

5512-1653_GB – 'Technical Description for METERTOOL & LogView

24 Troubleshooting

The meter has been constructed, with a view to quick and simple installation as well as long and reliable operation at the consumer. The meter housing is hermetically closed, and any repair requires that the sealing is broken. **Therefore, repairs must be carried out by Kamstrup A/S.**

Should you, however, experience an operating problem with the meter, the table below can be used for troubleshooting.

Before sending the meter, to repair or to check, please use the error detection table next page to help you clarify the possible cause of the problem.

Symptom	Possible reason	Proposal for correction
No display functions (empty display)	Battery flat	Send the meter to Kamstrup A/S
Info code DRY flashes in the display	The meter is not water-filled	Air the installation. The info code disappears when the meter is water-filled
Info code RADIO OFF flashes in the display	The meter is still in transport mode with the built-in radio transmitter turned off	The radio switches on and the info code disappears when the first ½ litre of water has run through the meter
Info code REVERSE flashes in the display	The meter is mounted with water flow in the wrong direction	Mount the meter in accordance with the flow arrow on the side of the meter case

25 Disposal

Kamstrup A/S holds an environmental certification according to ISO 14001, and as part of our environmental policy, we use materials, which recovers environmentally correct, to the greatest possible extent.

- **Disposal by Kamstrup A/S**

Kamstrup A/S accepts worn-out meters for environmentally correct disposal according to previous agreement. The disposal is free of charge to the customer, except for the cost of transportation to Kamstrup A/S.

- **The customer sends for disposal**

The meters must not be dis-assembled prior to dispatch. Hand in the complete meter, for approved national/local disposal. Enclose a copy of this page in order to inform the recipient of the contents.

- **Disposal by the customer himself**

Dis-assemble meters, as described below, and the separate parts handed in for approved destruction. Do not expose batteries to mechanical impact. Also avoid short-circuit of lead-in wires during transport. Also, see table below:

25.1 Instructions for disposal

Item	Material	Recommended disposal
Lithium cells	Lithium-thionylchloride >UN 3090< C-cell: 2.0 g lithium	Approved deposit of lithium cells
Printed circuits (remove LCD-display)	Coppered epoxy laminate, components soldered on	PCB scrap for metal recovery
LCD-display	Glass and liquid crystals	Approved processing of LCD-displays
Meter housing, measuring tube, transducer holder	PPS – 40% fibreglass	Plastic recovery
Reflectors	Stainless steel	Metal recovery
Sight glass	Soda lime glass	Glass recovery
Top cover (type label)	ABS	Plastic recovery
Other plastic parts, casted	PC + 10% glass	Plastic recovery
Moisture-absorbent	98% Bentonite 2% Quartz	Ordinary disposal
Packing	APET - (Amorphous Polyethylene Terephthalate) – also used for storage of food	Plastic recycling 'Combustible'

Please send any questions you may have regarding environmental matters to:

Kamstrup A/S

Att.: Quality and environmental dept.

Fax: +45 89 93 10 01

info@kamstrup.com

Kamstrup A/S
Industrivej 28, Stilling
DK-8660 Skanderborg
TEL: +45 89 93 10 00
FAX: +45 89 93 10 01
info@kamstrup.com
kamstrup.com

Think forward