

Installation and user's guide

## MULTICAL® 403



## Information

---

### Permissible operating conditions / measuring ranges

Approved heat meter in accordance with MID and EN1434:

Temperature Range  $\theta$ : 2 °C...180 °C  $\Delta\theta$ : 3 K...178 K

Flow sensor (temperature of medium)  $\theta_q$ : 2 °C...130 °C

Approved cooling meter in accordance with DK-BEK 1178 and EN1434:

Temperature Range  $\theta$ : 2 °C...180 °C  $\Delta\theta$ : 3 K...178 K

Flow sensor (temperature of medium)  $\theta_q$ : 2 °C...130 °C/ $\theta_q$ : 2 °C...50 °C (MULTICAL® 403-C)

### MID designation

#### Mechanical environment

Class M1 and M2

#### Electromagnetic environment

Class E1 (housing/light industry). The meter's control cables must be drawn at min. 25 cm distance from other installations.

#### Climatic environment

Non-condensing, closed location (installation indoors), ambient temperature 5...55 °C.

#### Maintenance and repair

The district heating supplier can replace temperature sensor pair, battery and communication module. The flow sensor must not be separated from the calculator. Other repairs require subsequent reverification in an accredited laboratory.

#### Selecting a temperature sensor pair

MULTICAL® 403-W - Pt500 - Heat meter

MULTICAL® 403-T - Pt500 - Heat/cooling meter

MULTICAL® 403-V - Pt100 - Heat meter

MULTICAL® 403-C - Pt500 - Cooling meter

#### Battery for replacement

Kamstrup type HC-993-02 (1 x D cell)

Kamstrup type HC993-09 (2 x A cell)

#### Communication Modules

For an overview of available modules we refer to section 9, page 16.

# Contents

---

<b>1</b>	<b>General information</b>	<b>4</b>
<b>2</b>	<b>Mounting of temperature sensors</b>	<b>5</b>
2.1	Short direct sensor (DS)	5
2.2	Pocket sensor (PL)	6
2.3	Temperature sensor compatibility with flow sensors	6
<b>3</b>	<b>Mounting of flow sensor</b>	<b>7</b>
3.1	Mounting of couplings and short direct sensor in flow sensor	7
3.2	Flow sensor position	8
3.3	Installation of MULTICAL® 403 flow sensor	8
3.4	Installation examples	10
3.5	Humidity and condensation	10
<b>4</b>	<b>Mounting the calculator</b>	<b>11</b>
4.1	Compact mounting	11
4.2	Wall mounting	11
4.3	Position of calculator	12
<b>5</b>	<b>Information codes "INFO"</b>	<b>13</b>
<b>6</b>	<b>Power supply</b>	<b>14</b>
6.1	Battery supply	14
6.2	Mains supply	14
<b>7</b>	<b>Testing of function</b>	<b>15</b>
<b>8</b>	<b>Electrical connection</b>	<b>15</b>
<b>9</b>	<b>Communication modules</b>	<b>16</b>
9.1	Module overview	16
9.2	Pulse inputs	16
9.3	Pulse outputs	17
9.4	Data Pulse, inputs (In-A, In-B), type HC-003-10	17
9.5	Data Pulse, outputs (Out-C, Out-D) , type HC-003-11	17
9.6	Wired M-Bus, inputs (In-A, In-B), type HC-003-20	18
9.7	Wired M-Bus, outputs (Out-C, Out-D), type HC-003-21	18
9.8	Wireless M-Bus, inputs (In-A, In-B), 868 MHz, type HC-003-30	18
9.9	Wireless M-Bus, outputs (Out-C, Out-D), 868 MHz, type HC-003-31	18
9.10	Analog outputs 2 x 0/4...20 mA, type HC-003-40	19
9.11	PQT Controller, type HC-003-43	19
9.12	Low Power Radio, inputs (In-A, In-B), 434 MHz, type HC-003-50	19
9.13	Low Power Radio GDPR, inputs (In-A, In-B), 434 MHz, type HC-003-51	19
9.14	LON TP/FT-10, inputs (In-A, In-B), type HC-003-66	20
9.15	Modbus RTU, inputs (In-A, In-B), type HC-003-67	20
<b>10</b>	<b>Set-up via front keys</b>	<b>21</b>

# 1 General information

---

**⚠ Please read this guide carefully before mounting the energy meter.  
In case of incorrect mounting, Kamstrup's guarantee obligations no longer apply.**

Please note that the following installation conditions must be obeyed:

- Pressure stage: PN16/PN25, see marking.
- Pressure stage, Kamstrup sensor pair type DS: PN25
- Pressure stage, Kamstrup pocket sensors type PL: PN25

At medium temperatures above 90 °C we recommend flange sensors as well as wall-mounting of calculator.

At medium temperatures below ambient temperature, MULTICAL® 403 must be wall mounted and the condensation-proof version, type 403-C, must be used. In case of bidirectional heat/cooling energy metering, type 403-T is used.

## 2 Mounting of temperature sensors

The temperature sensors used for measuring inlet and outlet temperatures respectively, constitute a matched sensor pair, which must never be separated. According to EN 1434/0IML R75, the cable length must not be changed. Should replacement be necessary, both sensors must be replaced.

The sensor marked with a red sign is to be installed in the inlet pipe. The other sensor, marked with a blue sign, is to be installed in the outlet pipe. For mounting in the calculator, see the paragraph "Electrical connection".

**Note:** The sensor cables must neither be exposed to jerking nor pulling. Please be aware of this when binding the cables, and be careful not to pull the binders unnecessarily tight as this may damage the cables. Please also note that temperature sensors must be mounted from below in cooling and heat/cooling installations.

### 2.1 Short direct sensor (DS)

The short, direct sensors up to DN25 can be mounted in special ball valves with built-in M 10 socket for the short direct sensor. They can also be mounted in installations with standard tee-pieces. Kamstrup A/S can supply R $\frac{1}{2}$  and R $\frac{3}{4}$  brass nipples that fit the short direct sensors. The short direct sensor can also be mounted directly in selected flow sensors from Kamstrup A/S. Fasten the sensors' brass unions lightly (approx. 4 Nm) using a 12 mm face wrench, and seal the sensors with seal and locking wire.

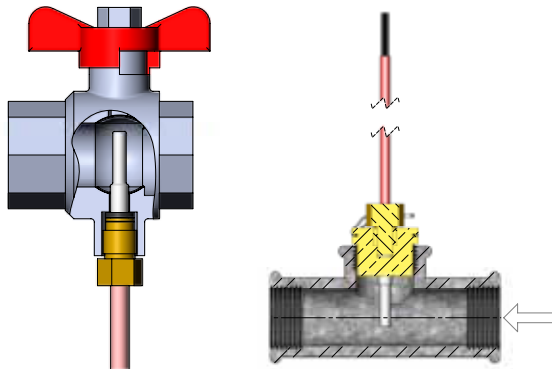

## 2.2 Pocket sensor (PL)

The sensor pockets can be mounted in e.g. a welding sleeve or in a 45° lateral Y-piece. The tip of the sensor pocket must be placed in the middle of the flow. Push the temperature sensors as deep as possible into the pockets. If a short response time is required, "non-hardening" thermally conductive paste can be used. Push the plastic sleeve on the sensor cable into the sensor pocket and secure the cable by means of the enclosed M4 sealing screw. Fasten the screw with your fingers only. Seal the pockets using seal and locking wire.

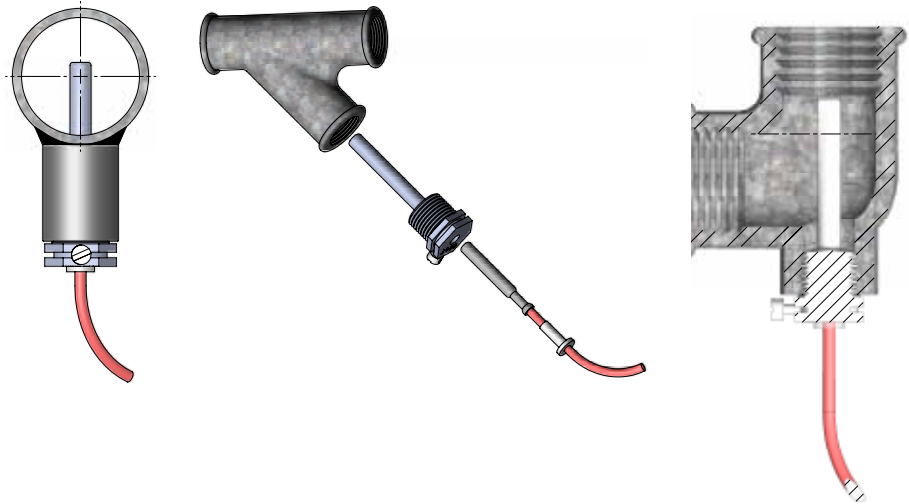



## 2.3 Temperature sensor compatibility with flow sensors

The size of the flow sensor determines which temperature sensors you can use and how they are mounted. The below table shows which temperature sensor types to use with which flow sensor.

Flow sensor			Temperature sensor		
$q_p$	DN	G	Can be mounted in flow sensor.		<u>Cannot</u> be mounted in flow sensor.
			DS 27.5	DS 38	Ø5.8 mm pocket
0.6-1.5	15	G½B	X		
0.6-1.5	20	G1B	X		
3.5-6	25	G5/4B	X		
10	40	G2B		X	
15	50	-			X

### 3 Mounting of flow sensor

Prior to installation of the flow sensor, the system should be flushed and protection plugs/plastic diaphragms removed from the flow sensor.

Correct position of the flow sensor appears either from the calculator's type label or from the display where  indicates the position in inlet, whereas  indicates the position in outlet. The flow direction is symbolised by an arrow on the flow sensor.

#### 3.1 Mounting of couplings and short direct sensor in flow sensor

The flow sensor can be used in connection with either PN16 or PN25 (see marking).

Any provided blind plug, extension and gland can be used with both PN16 and PN25.

**In connection with flow sensors with the nominal dimensions G½Bx110 mm and G1Bx110 mm, it must be checked if the thread run-out is sufficient.**

Couplings and gaskets are mounted as shown in the figure. Make sure to position the gasket correctly in the recess of the gland as shown in the details excerpt in the figure.

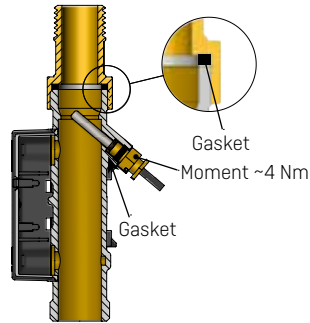

Kamstrup flow sensors require neither straight inlet nor straight outlet to meet the Measuring Instruments Directive (MID) 2014/32/EU, OIML R75:2002 and EN 1434:2015. A straight inlet section will only be necessary in case of heavy flow disturbances before the meter. It is recommended to follow the guidelines of CEN CR 13582.

### 3.2 Flow sensor position

- A** Recommended position.
- B** Recommended position.
- C** Unacceptable position due to risk of air build-up.
- D** Acceptable position in closed systems.
- E** Ought not to be placed immediately after a valve, with the exception of block valves (ball valve type) which must be fully open when not used for blocking.
- F** Ought not to be placed immediately before or after a pump.
- G** Ought not to be placed immediately after a double bend in two planes.

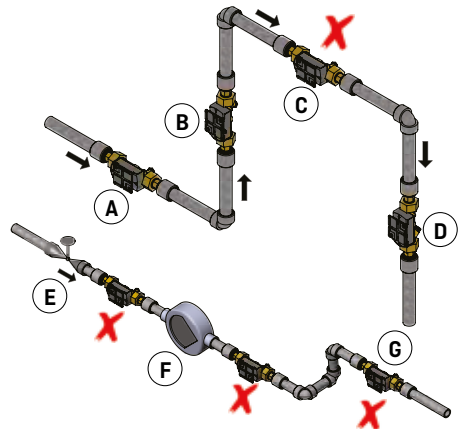

In order to avoid cavitation, the back pressure at the flow sensor (the pressure at the flow sensor outlet) must be minimum 1.5 bar at  $q_p$  (nominal flow) and minimum 2.5 bar at  $q_s$  (maximum flow). This applies to temperatures up to approx. 80 °C. The flow sensor must not be exposed to pressure lower than the ambient pressure (vacuum).

### 3.3 Installation of MULTICAL® 403 flow sensor

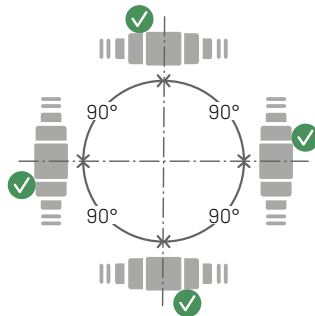

The flow sensor can be mounted horizontally, vertically or at an angle.



### 3.3.1 Screw-type meters 0.6...2.5 m<sup>3</sup>/h

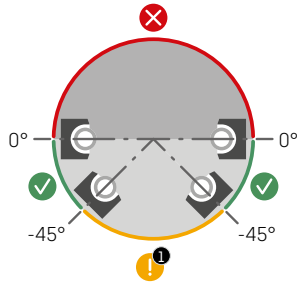

The flow sensor can be mounted at an angle of 0° and may be turned 90° downwards.

### 3.3.2 Flange meters and screw-type meters $\geq 3.5$ m<sup>3</sup>/h

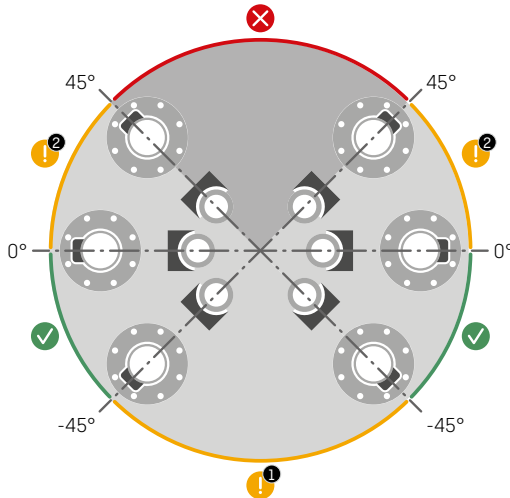

The flow sensor can be mounted at an angle of 0° and may be turned 45° upwards or 90° downwards.

**Note:** In installations where the media temperature is below the ambient temperature, MULTICAL® 403-T or 403-C must be used. At the same time, the flow sensor must not be installed with the plastic housing turned below 0°.

### 3.4 Installation examples

#### Threaded meter:

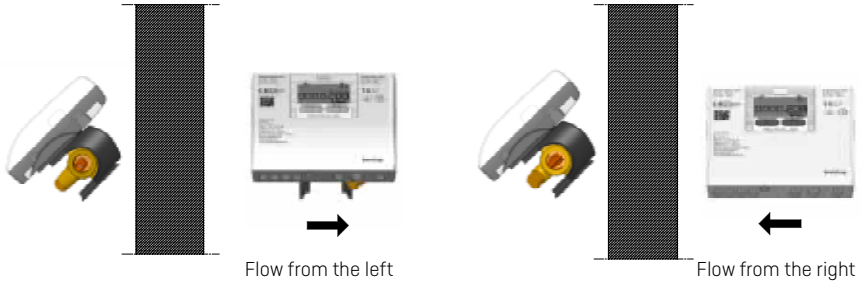

#### Flange meter:

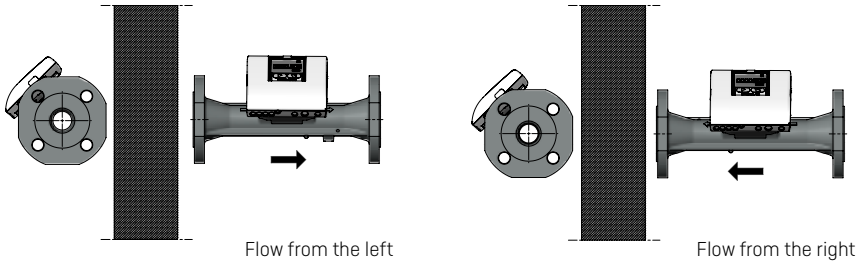

### 3.5 Humidity and condensation

If there is risk of condensation, e.g. in cooling systems, a condensation-proof MULTICAL® 403, type 403-C, must be used. In case of bidirectional heat/cooling energy metering, type 403-T is used.

## 4 Mounting the calculator

The MULTICAL® 403 calculator can be mounted in different ways; either direct on the flow sensor [compact mounting], or on a wall [wall mounting].

### 4.1 Compact mounting

Compact mounting means that the calculator is mounted directly on the flow sensor. Having been mounted, the calculator is sealed with seal and locking wire. If there is risk of condensation (e.g. in cooling applications), the calculator must be wall mounted. Furthermore, MULTICAL® 403 in cooling applications must be the condensation-proof version, type 403-C. In case of bidirectional heat/cooling energy metering, type 403-T is used.

The construction of MULTICAL® 403 always provides minimum installation depth in connection with compact mounting. Due to the design the mounting radius in critical places remains 60 mm, both at 45° and 90° mounting of the flow sensor.

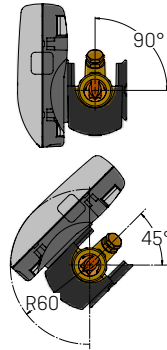

### 4.2 Wall mounting

MULTICAL® 403 can be mounted directly on an even wall. Wall mounting requires a wall fitting (3026-655), which is available as an accessory to MULTICAL® 403. Use the fitting as a template to mark and drill two 6 mm holes in the wall and mount the fitting using the enclosed screws and rawlplugs. Mount MULTICAL® 403 on the wall fitting by sliding the calculator onto the fitting in the same way as it is done in connection with compact mounting.

**Note:** For  $q_p$  3.5 flow sensors and larger it is possible to demount the bracket from the flow sensor and use it as a wall bracket.

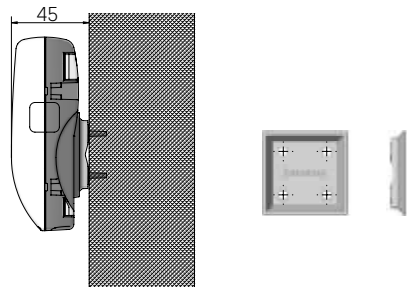

### 4.3 Position of calculator

If the flow sensor is installed in a humid or condensing environment, the calculator must be wall mounted and positioned higher than the flow sensor.

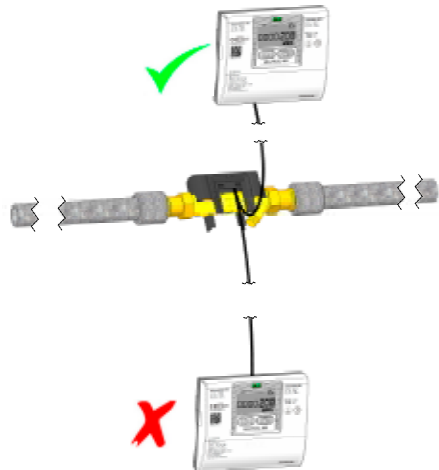

## 5 Information codes "INFO"

MULTICAL® 403 constantly monitors a number of important functions. If a serious error occurs in the measuring system or the installation, a flashing "INFO" will appear in the display. The "INFO"-field keeps flashing as long as the error is present no matter which reading you choose. The "INFO"-field is automatically switched off when the error has been corrected. The info code can be displayed in in TECH loop reading 2-017-00, for indication of current errors in MULTICAL® 403. The info code consists of 8 digits and each functionality has its own digit dedicated to the indication of relevant information. For instance all information concerning temperature sensor t1 is shown in the display as the second digit from the left.

Display digit								Description
1	2	3	4	5	6	7	8	
<b>Info</b>	<b>t1</b>	<b>t2</b>	<b>0</b>	<b>V1</b>	<b>0</b>	<b>In-A</b>	<b>In-B</b>	
1								No voltage supply
2								Low battery level
9								External alarm [e.g. via KMP]
	1							t1 Above measuring range or switched off
		1						t2 Above measuring range or switched off
	2							t1 Below measuring range or short-circuited
		2						t2 Below measuring range or short-circuited
	9	9						Invalid temperature difference [t1-t2]
				3				V1 Air
				4				V1 wrong flow direction
				6				V1 > q <sub>s</sub> for more than an hour
						8		Pulse input A, leakage in system
						9		Pulse input A, external alarm
							8	Pulse input B, leakage in system
							9	Pulse input B, external alarm

### Example:

```

: 1 : 0 : 2 : 0 : 0 : 0 : 9 : 0 :
:   :   :   :   :   :   :   :   :

```

## 6 Power supply

### 6.1 Battery supply

MULTICAL® 403 is available with battery supply using either two A-cell batteries or one D-cell battery. Optimal battery lifetime is obtained by keeping the battery temperature below 30 °C, e.g. by wall mounting. The voltage of a lithium battery is almost constant throughout the lifetime of the battery (approx. 3.65 V). Therefore, it is not possible to determine the remaining capacity of the battery by measuring the voltage. "INFO" code "2xxxxxx" however, indicates low battery level.

The battery cannot and must not be charged and must not be short-circuited. Used batteries must be handed in for approved destruction, e.g. at Kamstrup A/S. Further details appear from document on handling and disposal of lithium batteries (5510-408).

### 6.2 Mains supply

MULTICAL® 403 is available with supply modules for either 24 VAC or 230 VAC.

The modules are protection class II and are connected via two-wire cable (without earth) through the big cable bush, the second one from the right, at the bottom of the connection base. Use connecting cable with an outer diameter of 5-10 mm and ensure correct cable stripping as well as correct mounting of cable relief.

If connecting to 230 VAC, it is important to make sure that the whole installation complies with current regulations. The supply cable must not be protected by a fuse larger than the one permitted for the given cable size.

In connection with other types of installations or requirements for larger fuses than the ones listed above, it is necessary to consult a certified electrician for an individual evaluation of how the type of installation in question should be carried out.

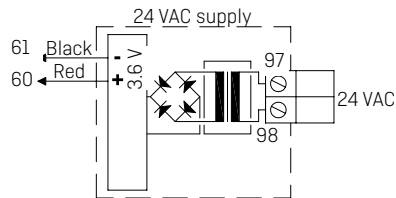

#### 24 VAC

E.g. transformer 230/24 V, type 66-99-403, can be used.

**Note:** MULTICAL® 403 cannot be powered by 24 VDC.

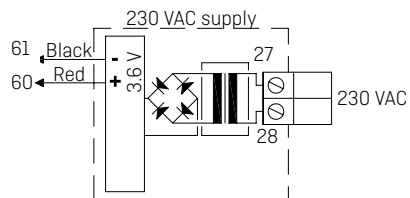

#### 230 VAC

This module is used when the meter is supplied directly by the mains.

**Note:** External supply must only be connected to the supply module.

## 7 Testing of function

---

Carry out an operational check when the energy meter has been fully mounted. Open thermoregulators and valves to enable water flow through the heating system. Activate the front key of MULTICAL® to change display reading, and check that the displayed values for temperatures and water flow are credible values.

## 8 Electrical connection

---

The two matched two-wire sensors are mounted in terminals 5 and 6 (t1) as well as 7 and 8 (t2). The polarity of temperature sensors t1 and t2 is without importance for the functionality.

Please also see the position of the terminals in the figure to the right:

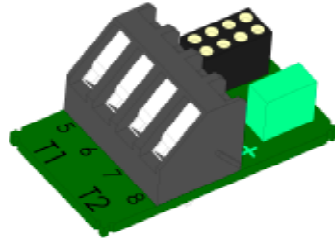

	<b>Terminal no.</b>	<b>Standard heat and cooling measurement</b>
t1	5-6	Sensor in inlet pipe (red label)
t2	7-8	Sensor in outlet pipe (blue label)











## 9 Communication modules

MULTICAL® 403 can be extended by a wide range of extra functions by means of communication modules. Below, pulse inputs/outputs and module types are briefly described.

**Note:** Before replacing or mounting modules, the supply to the meter must be switched off. The same applies for mounting of an antenna.

### 9.1 Module overview

MULTICAL® 403 communication modules:

Type No.	Description	
HC-003-10	Data Pulse, inputs (In-A, In-B)	
HC-003-11	Data Pulse, outputs (Out-C, Out-D)	
HC-003-20	Wired M-Bus, inputs (In-A, In-B)	
HC-003-21	Wired M-Bus, outputs (Out-C, Out-D)	
HC-003-22	Wired M-Bus, Thermal Disconnect	  
HC-003-30	Wireless M-Bus, inputs (In-A, In-B), 868 MHz	
HC-003-31	Wireless M-Bus, outputs (Out-C, Out-D), 868 MHz	
HC-003-40	Analog outputs 2 x 0/4...20 mA	 
HC-003-43	PQT Controller	 
HC-003-50	Low Power Radio, inputs (In-A, In-B), 434 MHz	
HC-003-51	Low Power Radio GDPR, inputs (In-A, In-B), 434 MHz	
HC-003-66	BACnet MS/TP, inputs (In-A, In-B)	
HC-003-67	Modbus RTU, inputs (In-A, In-B)	

 The module requires that the meter is mains-supplied.

 The module requires an external power supply.

 The module requires a specific configuration in the meter, see the module data sheet for details.

### 9.2 Pulse inputs

Pulse inputs A and B are used for connection of extra meters with either Reed-switch output or passive electronic pulse output.

Min. pulse duration is 30 ms. and max pulse frequency is 3 Hz.

65 + Pulse input A  
66 -

67 + Pulse input B  
68 -

If a module with pulse inputs is mounted in MULTICAL®, the meter is automatically configured for pulse inputs. Note that the meter factor (litres/pulse) must match the extra water meters and the configurations of inputs A and B. After delivery, the configurations of pulse inputs A and B can be changed by means of the PC program METERTOOL HCW.



### 9.3 Pulse outputs

Pulse outputs for energy and volume are made with Optp Fet and are available on a number of the communication modules.

Max voltage and current of the outputs are 45 VDC and 50 mA, respectively.

When a module with pulse outputs is mounted in MULTICAL®, the meter is automatically configured for pulse outputs. The pulse duration is ordered at 32 ms. or 100 ms. After delivery the pulse duration can be changed by means of the PC program METERTOOL HCW.

The resolutions of the pulse outputs always follow the least significant digit displayed for energy and volume respectively.

16 +  
17 - Pulse output C

18 +  
19 - Pulse output D

### 9.4 Data Pulse, inputs (In-A, In-B), type HC-003-10

The data terminals are, for example, used for connecting a PC. The signal is passive and galvanically separated. In order to read data, an active converter cable, 66-99-106 [D-SUB 9F] or 66-99-098 [USB type A] is required. The converter cable must be connected as follows:

62	Brown	[DAT]
63	White	[REQ]
64	Green	[GND]



### 9.5 Data Pulse, outputs (Out-C, Out-D), type HC-003-11

The data terminals are, for example, used for connecting a PC. The signal is passive and galvanically separated. In order to read data, an active converter cable, 66-99-106 [D-SUB 9F] or 66-99-098 [USB type A] is required. The converter cable must be connected as follows:

62	Brown	[DAT]
63	White	[REQ]
64	Green	[GND]



### 9.6 Wired M-Bus, inputs (In-A, In-B), type HC-003-20

M-Bus modul with primary, secondary and enhanced secondary addressing.

The module is connected to an M-Bus master via terminals 24 and 25 using a twisted pair. M-Bus is not polarised so that the wires can be connected randomly.



### 9.7 Wired M-Bus, outputs (Out-C, Out-D), type HC-003-21

M-Bus modul with primary, secondary and enhanced secondary addressing.

The module is connected to an M-Bus master via terminals 24 and 25 using a twisted pair. M-Bus is not polarised so that the wires can be connected randomly.



### 9.8 Wireless M-Bus, inputs (In-A, In-B), 868 MHz, type HC-003-30

The Wireless M-Bus module has been designed to be part of Kamstrup's hand-held Wireless M-Bus Reader system, which operates within the unlicensed frequency band in the 868 MHz area. The radio module is available with either internal or external antenna.



### 9.9 Wireless M-Bus, outputs (Out-C, Out-D), 868 MHz, type HC-003-31

The Wireless M-Bus module has been designed to be part of Kamstrup's hand-held Wireless M-Bus Reader system, which operates within the unlicensed frequency band in the 868 MHz area. The radio module is available with either internal or external antenna.



**!** The wireless M-Bus module must be connected to an internal or external antenna. When mounting an external antenna, ensure that the antenna cable is not jammed or damaged when the calculator is assembled. Before replacing or mounting modules, the supply to the meter must be switched off. The same applies to mounting of an antenna.

### 9.10 Analog outputs 2 x 0/4...20 mA, type HC-003-40

Analog module with 2 pcs. 0/4...20 mA current outputs. The current is measured directly via the 2 sets of output terminals 80-81 and 82-83.

- ⚡ The module requires that the meter is mains-supplied.
- ⚡ The module requires an external power supply.



### 9.11 PQT Controller, type HC-003-43

PQT Controller module with output for regulating a three-point motor-operated valve. The module is used for regulating power, flow and temperature in the installation. The motor valve is connected to terminals 150, 151 and 152. Regulation of the bypass direction of the motor valve can be made by short-circuiting the test points Up or Dn.

- ⚡ The module requires that the meter is mains-supplied.
- ⚡ The module requires an external power supply.



### 9.12 Low Power Radio, inputs (In-A, In-B), 434 MHz, type HC-003-50

The Low Power Radio module is designed to be part of Kamstrup's reading system or of a radio mesh network. The module is available with either internal or external antenna.

- 📶 The module requires a specific configuration in the meter, see the module data sheet for details.



### 9.13 Low Power Radio GDPR, inputs (In-A, In-B), 434 MHz, type HC-003-51

The Low Power Radio GDPR module is designed to be part of Kamstrup's reading system or of a radio mesh network. The module is available with either internal or external antenna.

- 📶 The module requires a specific configuration in the meter, see the module data sheet for details.



**9.14 LON TP/FT-10, inputs (In-A, In-B), type HC-003-66**

BACnet is often used in building automation systems and industrial applications.

The module is BACnet-certified and registered in the BTL list. The module communicates via RS485 with speeds up to 115200 baud. The twisted shielded cables are connected to the terminals 137, 138 and 139.

- The module requires that the meter is mains-supplied.



**9.15 Modbus RTU, inputs (In-A, In-B), type HC-003-67**

Modbus is often used in building automation systems and industrial applications. The module is a Modbus RTU slave device, which is verified against the Modbus Implementation Guide V1.02.

The module communicates via RS485 with speeds up to 115200 baud. The twisted shielded cables are connected to the terminals 137, 138 and 139.

- The module requires that the meter is mains-supplied.



## 10 Set-up via front keys

It is possible to set up a number of parameters in MULTICAL® 403 at the installation site. The setup is carried out via the SETUP loop that is available as long as MULTICAL® 403 is in transport state\*, or until you finish the setup with "EndSetup". If the meter has been put into operation and is thus no longer in transport state, it is necessary to break the meter's installation seal to be able to access the SETUP loop again. This is done by separating and immediately after reassembling the top and base of the calculator. Thereafter, the meter must be sealed with sealing wire and/or sealing label to be used for billing purposes.

You go from USER loop to SETUP loop by pressing the left key (primary key) for 9 s. After 4 min. without activation of the front keys the meter returns to energy reading in USER loop.

SETUP loop does not include secondary readings, and, therefore, the index number always consists of 4 digits. In SETUP loop the right key (secondary key) is used for accessing individual readings with the purpose of changing parameters.

SETUP loop		Index number in display
1.0	Customer number [N° 1]	3-001
2.0	Customer number [N° 2]	3-002
3.0	Date	3-003
4.0	Time**	3-004
5.0	Yearly target date 1 (mm.DD)	3-005
6.0	Monthly target date 1 (DD)	3-006
7.0	Flow sensor position: inlet or outlet flow (A-code)	3-007
8.0	Measuring unit and resolution [B and CCC-codes are configured as e.g. "0.001 MWh" and "0.01 m³"]	3-008
9.0	Primary Address Module [N° 35]	3-009
10.0	Average time for min./ max. P and Q	3-010
11.0	$\theta_{hc}$ ***	3-011
12.0	t offset	3-012
13.0	Radio "ON" or "OFF"	3-013
14.0	Input A [pre-set register]	3-014
15.0	Input B [pre-set register]	3-015
16.0	Meter no. of Input A	3-016
17.0	Meter no. of Input B	3-017
18.0	TL2	3-018
19.0	TL3	3-019
20.0	TL4	3-020
21.0	t5	3-021
22.0	EndSetup	3-022

\* MULTICAL® 403 remains in transport state until flow is registered for the first time.

\*\* The clock can be adjusted under installation seal via the front keys or the PC-program METERTOOL HCW. Furthermore, all modules can adjust the clock.

\*\*\* $\theta_{hc}$  can only be changed in meters configured as meter type 6. Upon attempts to access this menu in meters configured with other country codes the display shows the message "Off".



# User Guide

## Energy measurement

MULTICAL® 403 functions as follows:

**The flow sensor** registers the quantity of water which circulates through the system in cubic metres (m<sup>3</sup>).

**The temperature sensors** mounted in inlet and outlet pipes register the cooling, i.e. the difference between inlet and outlet temperatures.

**MULTICAL® 403** calculates energy consumption on the basis of volume of water and temperature difference.

## Readings in the display

When the primary key ► is activated, a new primary reading is displayed. The secondary key ◼ is used to display historical readings and average values.

Four minutes after the latest activation of any front key, reading automatically changes to consumed energy.

## Display readings

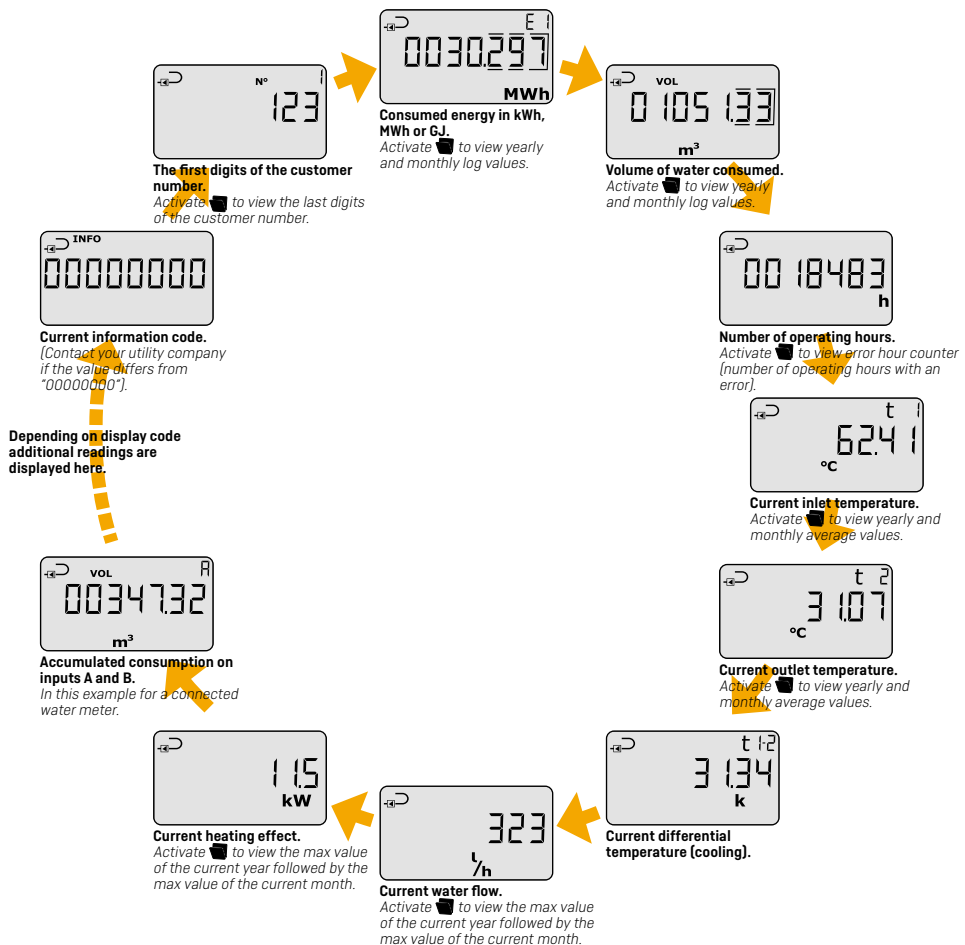

Display readings are based on **DDD-code 210**. At [kamstrup.com](http://kamstrup.com) you find a selection of interactive user guides based on other DDD-codes.

User Guide

## MULTICAL® 403

