

VPEL - Differential pressure transmitter for water



VPEL differential pressure transmitter is designed for measuring water/glycol pressures in heating and cooling systems. The transmitters can measure differential pressure and over/under pressures.

Technical specifications

Property	Value
Supply	24 Vac/dc, 45 mA (15...32 V)
Measuring ranges	
VPEL 1.0/2.5	0...1.0 bar / 0...2.5 bar (= L/H)
VPEL 4.0/6.0	0...4.0 bar / 0...6.0 bar (= L/H)
Measurement accuracy	±2.5 % of full measurement scale
Temperature drifting	< 0.5 % of full scale / 10 K
Long term stability / year	±0.03 bar
Zeroing	manual, by a push button
Outputs	0...10 Vdc < 8 mA or 4...20 mA < 500 Ω
Cable entry	M16
Operating conditions	
Ambient temperature	-20...70 °C
Medium temperature	-20...100 °C
Maximum static operation pressure	16 bar
Maximum momentary pressure	
VPEL 1.0/2.5	+ connection: 7.5 bar, - connection: 5.0 bar
VPEL 4.0/6.0	+ connection: 18.0 bar, - connection: 12.0 bar
Storage temperature	-20...70 °C
Wiring terminals	1,5 mm ² , tilted screw terminals
Mounting	on the wall by screws and process connections by 8 mm copper pipes
Protection class	IP54, measurement connections downwards
Materials	
Wetting parts	brass, ceramics



Property	Value
Housing	PC plastic
Dimensions (w x h x d)	118 x 113 x 46 mm

Wiring





CAUTION **CAUTION:** Device wiring and commissioning can only be carried out by qualified professionals. Always make the wirings while the power is switched off.

24 Vac/dc	1	▶	VPEL
0 V	2	⊥	
0...10 Vdc output	3	◀	
4...20 mA output	4	◀	

Jumper settings

			
Output	S1	0...10 Vdc	4...20 mA
Range	S2	VPEL 1.0/2.5: 0...2.5 bar VPEL 4.0/6.0: 0...6.0 bar	VPEL 1.0/2.5: 0...1.0 bar VPEL 4.0/6.0: 0...4.0 bar

Ordering information

	Type	Product number	Description
	VPEL 1.0/2.5	1134060	Differential water pressure transmitter, range 0...1.0 bar / 0...2.5 bar
	VPEL 1.0/2.5-N	1134061	Differential water pressure transmitter, display, range 0...1.0 bar / 0...2.5 bar
	VPEL 4.0/6.0	1134070	Differential water pressure transmitter, range 0...4.0 bar / 0...6.0 bar
	VPEL 4.0/6.0-N	1134071	Differential water pressure transmitter, display, range 0...4.0 bar / 0...6.0 bar

Dimensions

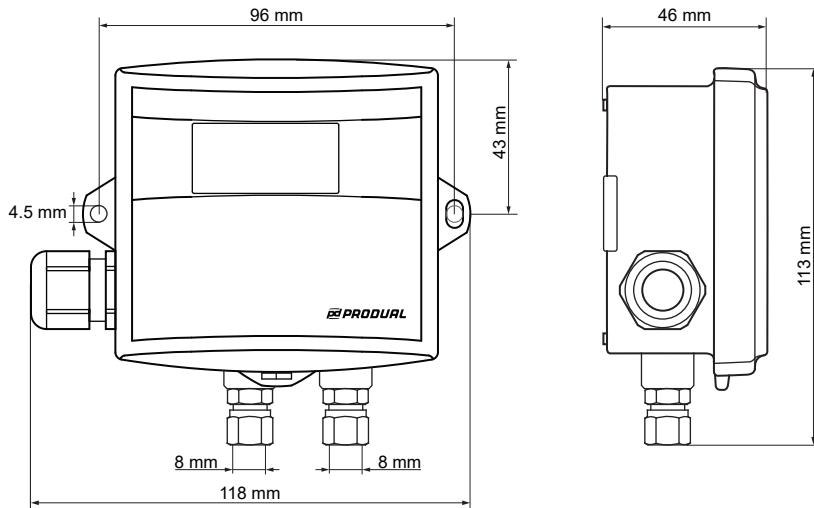

Supported standards and directives

Standard	Description
2014/30/EU	Electromagnetic Compatibility (EMC).
2011/65/EU	Restriction of Hazardous Substances (RoHS2) Directive.
(EU) 2015/863	Commission Delegated Directive, amending Annex II to Directive 2011/65/EU.
EN 61000-6-3:2007/ A1:2011	Electromagnetic compatibility (EMC) - Part 6-3: Generic standards - Emission standard for residential, commercial and light-industrial environments.
EN 61000-6-2:2006	Electromagnetic compatibility (EMC) - Part 6-2: Generic standards - Immunity for industrial environments.