

### Freezing Protection

- Use a filter < 1 mm, 16 mesh (see previous chapter on Strainers).
- Use an antifreeze when the evaporation temperature is close to liquid-side freezing.
- Use a freeze protection thermostat and flow switch to guarantee a constant water flow before, during and after compressor operation.
- Avoid "pump-down" function.
- When starting up a system, wait a moment before starting the condenser (or have reduced flow through it).

### Condensers

The refrigerant (gas) should be connected to the upper left connection, F1, and the condensate to the lower left connection, F3. The water/brine circuit inlet should be connected to the lower right connection, F4, and the outlet to the upper right connection, F2.

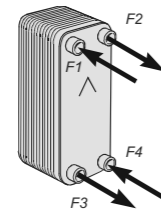

BPHEs with UL approval for use with CO<sub>2</sub> according to UL files section II or VI. For use with CO<sub>2</sub>, the system should include a pressure relief valve on each side of the brazed plate heat exchanger. The pressure relief valve must be opened if the system pressure reaches 0.9 x design pressure.

### CLEANING OF THE BPHEs

Thanks to the normally very high degree of turbulence in BPHEs there is a self-cleaning effect in the channels. However, in some applications the fouling tendency can be very high, e.g. when using extremely hard water at high temperatures. In such cases it is always possible to clean the exchanger by circulating a cleaning liquid (CIP - Cleaning In Place). Use a tank with weak acid, 5% phosphoric acid or, if the exchanger is frequently cleaned, 5% oxalic acid. Pump the cleaning liquid through the exchanger.

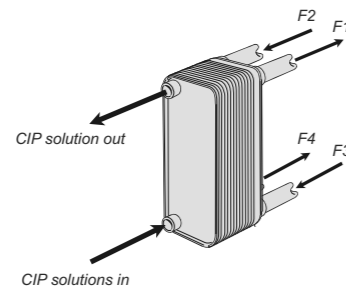

For tough installations we recommend factory-installed CIP connections/valves for easy maintenance.

For optimum cleaning, the cleaning solution flow rate should be a minimum of 1.5 times the normal flow rate, preferably in a back-flush mode. After use, do not forget to rinse the heat exchanger carefully with clean water. A solution of 1-2% sodium hydroxide (NaOH) or sodium bicarbonate (NaHCO<sub>3</sub>) before the last rinse ensures that all acid is neutralized. Clean at regular intervals.

For further information about cleaning of the BPHEs, please consult SWEP's CIP information or your local SWEP company.

### STORAGE

BPHEs are to be stored dry. The temperature should not be below 1°C and not over 50°C for long term storage (more than 2 weeks).

### WARRANTY

SWEP offers a 12-month warranty from the date of installation, but in no case longer than 15 months from the date of delivery. The warranty covers only manufacturing and material defects.

### DISCLAIMER

SWEP's BPHE performance is based on installation, maintenance and operating conditions done in conformance with this manual. SWEP cannot assume any liability for BPHEs that do not meet these criteria.

The heat exchanger is not type-approved for fatigue loading

For further information, please consult SWEP's technical information or your local SWEP company.

# INSTALLATION AND MAINTENANCE MANUAL FOR BPHEs

### GENERAL INFORMATION

Depending on material combinations, pressure ratings and functions, there are several different types of Compact Brazed Heat Exchangers (BPHEs). The standard materials are stainless steel, vacuum-brazed with a pure copper or nickel-based filler.

The basic materials of construction indicate the type of fluids that SWEP's BPHEs can be used with. Typical examples are: synthetic or mineral oil, organic solvents, water (not seawater), glycol mixtures (ethylene and propylene glycol), refrigerants (e.g. HCFC). Please note that if natural refrigerants (e.g. ammonia) are employed, BPHEs with nickel-based brazing material must be used.

The front plate of SWEP's BPHE is marked with an arrow. Either of an adhesive sticker type or embossed in the cover plate. The purpose of this marker is to indicate the front side of the BPHE and the location of the inner and outer circuits/channels. With the arrow pointing up, the left side (Port F1, F3) is the inner circuit and the right side (Port F2, F4) is the outer circuit.

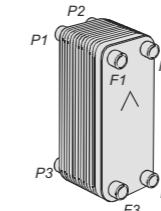

The outer circuit has a slightly lower pressure drop as it contains one more channel.

Ports F1/F2/F3/F4 are situated on the front of the heat exchanger. Ports P1/P2/P3/P4 are situated on the back. Note the order in which they appear.

### CONSTRUCTION

The BPHE is in principle built up by a plate package of corrugated channel plates between front and rear cover-plate packages. The cover plate packages consist of sealing plates, blind rings and cover plates. The connections can be customized to meet specific market and application requirements. During the vacuum-brazing process, a brazed joint is formed at every contact point between two plates. The design creates a heat exchanger that consists of two separate circuits.

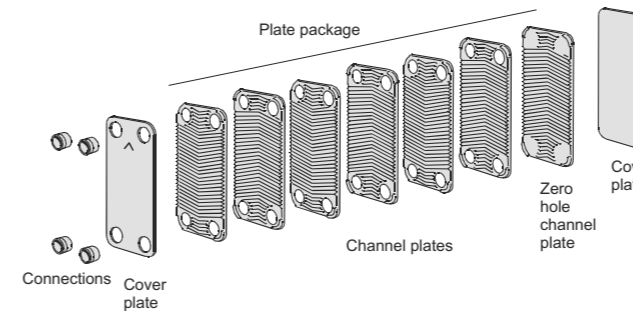

Sealing plates are used to seal off the space between the cover plate and the first and last channel plate. The number of cover plates varies, e.g. with the type and size of BPHE and its respective pressure rating.

Some BPHEs have a blind ring for the purpose of sealing off the space between the channel plate and the cover plate. In some BPHEs the blind rings are integrated in the cover plate and first/last channel plates.

### Material Combinations

There are different types of BPHE product categories depending on material combinations and design pressures. The standard plate materials are stainless steel, S, of AISI 316 type (1.4401 or 2343), vacuum-brazed with a pure copper filler, C, or a nickel-based filler, N. Carbon steel can be used to some extent, e.g. for certain types of connections. For demanding applications, the plates can be made of SMO 254, a stainless steel with a higher content of molybdenum, M. There are BPHEs available for standard pressure rating, S, high pressure rating, H or ultra high pressure rating, U. The material and pressure denominations are shown below.

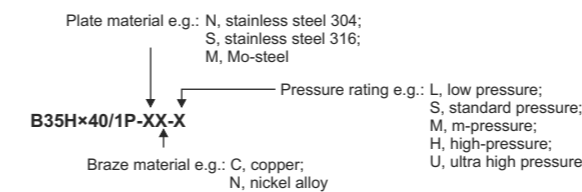

Table 1: Examples of BPHEs with various material and design pressures

BPHE Categories	Denomination	Explanation
Standard BPHEs	B25T/1P-SC-S	B25T with stainless steel plates brazed with copper. Standard pressure rating.
High Pressure BPHEs	B25T/1P-SC-H	B25T with stainless steel plates brazed with copper. High pressure rating.
Nickel brazed BPHEs	B10T/1P-SN-S	B10T with stainless steel plates brazed with nickel alloy. Standard pressure.
Mo-steel BPHEs	B120T/1P-MC-S	B120T with Mo-steel plates brazed with copper. Standard pressure rating.
304-steel BPHEs	B120T/1P-NC-S	B120T with 304-steel brazed with copper. Standard pressure rating.

### BPHE Plates and Channel Types

Some BPHEs are available with different types of channel plates where the herringbone pattern varies. The chevrons can be obtuse (creating a high theta plate, H) or acute (creating a low theta plate, L).

Plates: H L Channels: H L M (MH&ML)

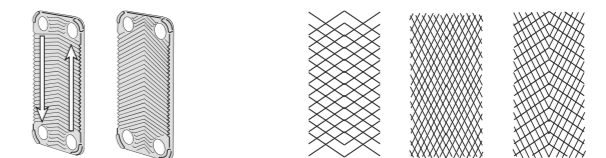

By mixing high and low theta plates, the thermal characteristics of the BPHE can be modified. For example one can have a BPHE with the same pressure drop on both sides despite different flow rates.

### FLOW CONFIGURATIONS

The fluids can pass through the heat exchanger in different ways. For parallel-flow BPHEs, there are two different flow configurations: co-current or counter-current.

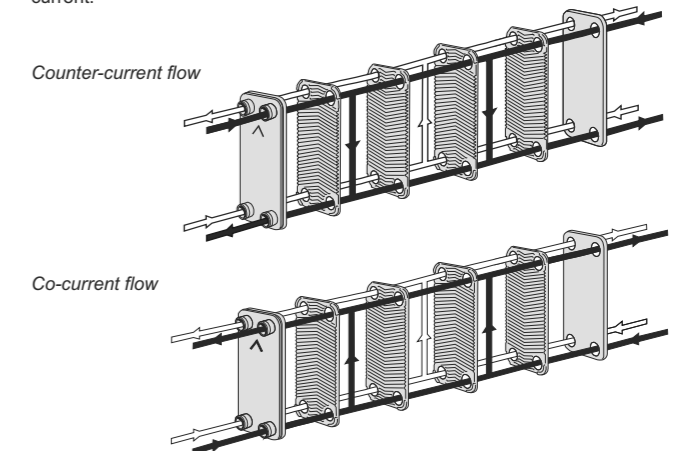

B9, B60 and D700 have a cross-flow configuration, instead of the parallel flow normally found in BPHEs. In B9 and B60 the ports F1-F4 are equivalent to the outer circuit and the ports F2-F3 are equivalent to the inner circuit. For D700 the F5-F6 ports are the outer circuit and F1-F4 and F2-F3 are the inner circuits.

When using the B60 exchanger in single-phase applications, you get the same results with these two different installations, but as a condenser it is very important that the gas inlet is port F1 and the outlet F4.

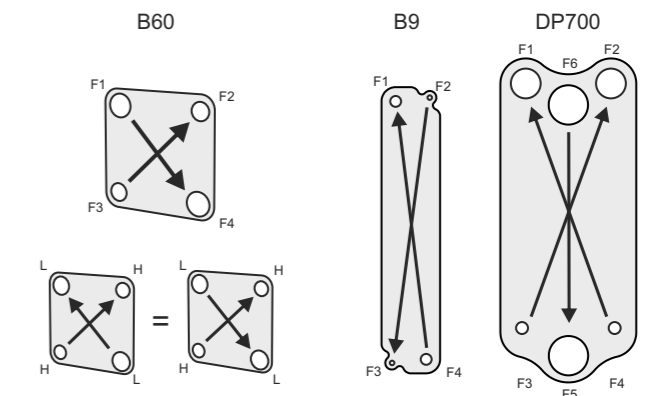

### SWEP INTERNATIONAL AB

Box 105, SE-261 22 Landskrona, Sweden  
Phone +46 418 40 04 00 Fax +46 418 292 95 Internet: www.swep.net E-mail: info@swep.net

### Different versions available

There are several different versions of the channel plate packages. Below are a couple of examples.

Dual-Circuit BPHE (.../D)

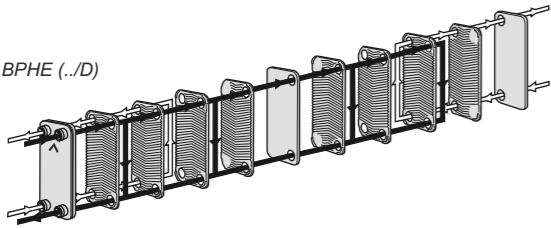

Two-Pass BPHE (.../2P), which corresponds to two units connected in series.

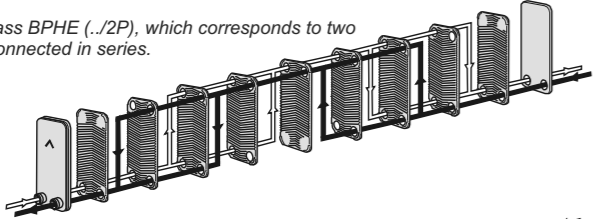

Dual-over-Two-Pass BPHE (.../D2P)

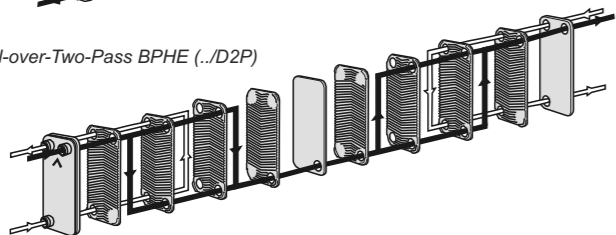

### DESIGN CONDITIONS AND APPROVALS

The standard pressure rating for SWEP BPHEs, i.e. maximum operating pressure, is 31 bar (3.1 MPa, 450 psi). SWEP's standard maximum operating temperature is 225°C (437°F) for copper-brazed BPHEs, and 350°C (660°F) for Nickel brazed BPHEs. However, as temperature and pressure are closely coupled, there is a possibility to increase the pressure if the temperature is reduced. For details, please check the label and other technical documentation.

SWEP's BPHEs are approved by a number of independent bodies, e.g.

- Europe, Pressure Equipment Directive (PED)
- USA, Underwriters Laboratories (UL)
- Japan, The High Pressure Gas Safety Institute of Japan (KHK)

SWEP also has design approvals, e.g. from: Lloyds Register, Great Britain; Det Norske Veritas (DNV), Norway; American Bureau of Shipping (ABS), USA; Korean Register of Shipping (KR).

A number of SWEP's BPHEs are approved by the European approval PED (Pressure Equipment Directive). For approved units the data on the label must not be exceeded at any circumstances. The heat exchangers are designed for use with fluids according to groupe1 in AFS 1999:4.

For operating conditions concerning the European approval PED, please see Product sheets on www.swep.net. For more details on the respective approvals, please contact SWEP.

### LABELING SYSTEM AND OPERATING CONDITIONS

All BPHEs are equipped with an adhesive label which includes vital information about the unit, e.g. type of heat exchanger (which indicates the basic BPHE execution and material combination) and SWEP's item number. The label also includes the serial number which is described below. The Operating Conditions; state the maximum operating temperature and pressure as per the respective approving organization.



2 00 11 715 2 0001

- Number in series
- Number of circuits
- Product code
- Month 11, i.e. November
- Year 00, i.e. 2000
- Production Entity

Bar-code serial number

The engraved Serial Number provides information about where and when the BPHE was produced.

### MOUNTING

Never expose the unit to pulsations or excessive cyclic pressure or temperature changes. It is also important that no vibrations are transferred to the heat exchanger. If there is a risk of this, install vibration absorbers. For large connection diameters, we advise you to use an expanding device in the pipeline. It is also suggested that e.g. a rubber mounting strip should be used as a buffer between the BPHE and the mounting clamp.

In single-phase applications, e.g. water-to-water or water-to-oil, the mounting direction has little or no effect on the performance of the heat exchanger, but in two-phase applications, the orientation of the heat exchanger becomes very important. In two-phase applications, SWEP's BPHEs should be mounted vertically, with the arrow on the front plate pointing upwards.

Several mounting suggestions for SWEP BPHEs are shown below. Mounting stud bolts, in different versions and locations, are available on the BPHEs as an option.

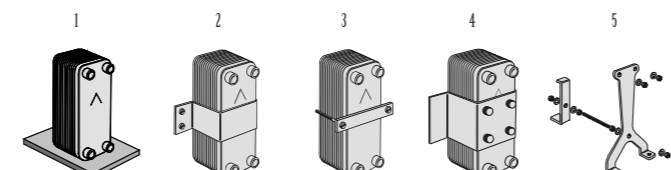

1. Supported from the bottom
2. Sheet metal bracket (rubber insert between bracket and exchanger)
3. Crossbar and bolts (rubber insert between the crossbar and exchanger)
4. Equipped with mounting stud bolts on the front or back cover plate
5. Support legs are available for some BPHEs

For smaller BPHEs it is also possible to mount the unit by simply suspending it from the pipes/connections.

### CONNECTIONS

All connections are brazed to the heat exchanger in the general vacuum brazing cycle, a process which gives a very strong seal between the connection and the cover plate. However, take care not to join the counterpart with such force that the connection is damaged.

Depending on the application, there are a lot of options available for the connections, different versions and locations, e.g. Compac flanges, SAE flanges, Rotolock, Victualic, threaded connections and welding connections. It is important to have the right international or local standard of connection, as they are not always compatible.

Rotolock Connections Victualic Connections Welding Connections



Flanges of DIN Type, Compac® flanges Flanges of SAE Type SAE O-Ring Connections



Some connections are equipped with a special plastic cap to protect the threads and sealing surface of the connection and to prevent dirt and dust from entering the BPHE. This plastic cap should be removed with care, in order not to damage the thread, sealing surface or any other part of the connection. Use a screwdriver, pliers or knife.

Some connections have an external heel. The purpose of the heel is to simplify the pressure and leakage testing of the BPHE in production.

### Threaded connections

Threaded connections can be female or male of well-known standards such as, ISO-G, NPT and ISO 7/1. The exterior can also be hexagonal which is shown below.

Externally Threaded Connections (Male) Internally Threaded Connections (Female) of Standard Type Internally Threaded Connections (Female) with a Hexagonal Exterior

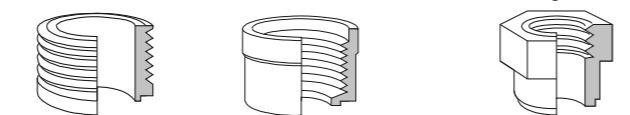

### Soldering Connections

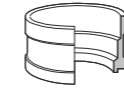

The soldering connections (sweat connections) are in principle designed for pipes with dimensions in mm or inches. The measurements correspond to the internal diameter of the connections. Some of SWEP's soldering connections are universal, i.e. fit both the mm and inch pipes. These are denominated xxU, such as the 28U which fits both the 1 1/8" and 28.75 mm.

All BPHEs are vacuum-brazed with either a pure copper filler or a nickel-based filler. Under normal soldering conditions (no vacuum), the temperature should not exceed 800°C (1470°F). **Too much heat could change the material structure resulting in internal or external leakage at the connection.** Because of this we recommend that all soldering is made with silver solder containing min. 45% silver. This type of solder has a relatively low soldering temperature and high moistening and fluidity properties.

Soldering flux is used in order to remove oxides from the metal surface, and thereby its property makes the flux potentially very aggressive. Consequently, it is very important to use the correct amount of flux. Too much might lead to severe corrosion, so no flux should be allowed to enter the BPHE.

Soldering connections are NOT recommended for welding, please choose welding connections instead.

### Soldering procedure

Degrease and polish the surfaces. Apply flux. Insert the copper tube into the connection, hold in place and braze with min. 45% silver solder at max. 650°C (1200°F). Do not direct the flame at the BPHE. Use a wet rag to avoid overheating the BPHE. Protect the BPHE's interior (refrigerant side) from oxidation with N<sub>2</sub> gas. **Warning:** Excessive heating can lead to fusion of the copper and thus to the destruction of the heat exchanger!

When SWEP supplies an adapter or flange which is soldered to the BPHE by the customer, SWEP does not assume any responsibility for erroneous soldering nor for any accidents that may occur during the process.

### Combo Connection

SWEP's multifunctional BPHEs have the new Combo Connection, which improve versatility and availability and makes it simpler for customers to find the right CBE for their needs. The innovative Combo Connection combines a standard ISO-G external thread with an internal soldering connection, enabling BPHEs to be coupled to the system by threads or a soldering joint using the same connection.

### Welding Connections

Welding is only recommended on specially designed welding connections. All SWEP's welding connections are executed with a 30° chamfer on top of the connection. Do not weld on pipes on other types of connections. The measurement in mm corresponds to the external diameter of the connection.



### Welding Procedure

- Protect the unit from excessive heating by:
  - a) using a wet cloth around the connection.
  - b) making a chamfer on the joining tube and connection edges as shown.

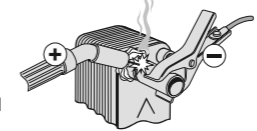

Use TIG or MIG/MAG welding. When using electrical welding circuits, connect the ground terminal to the joining tube, not to the back of the plate package. Internal oxidation can be reduced by a small nitrogen flow through the unit.

Make sure no traces of copper are adjacent to the prepared joint. If grinding is used for joint preparation, proper measures must be taken to prevent copper from being ground into the stainless surface.

### Allowable Connection Loads for Pipe Assembly Conditions

The maximum allowable connection loads given below are valid for low cycle fatigue. If high cycle fatigue is involved special analysis should be made.

Allowable connection loads for different pipe assembly conditions

Pipe Size	Shear Force, Fs	Tension Force, Ft	Bending Moment, Mb	Torque, Mt
	(kN)	(kN)	(Nm)	(kpm)
1/2"	3.5	2.5	20	35
3/4"	12	2.5	20	115
1"	11.2	4	40	155
1 1/2"	14.5	6.5	60	27
1 1/2"	16.5	9.5	155	35.5
2"	21.5	13.5	255	60
2 1/2"	44.5	18	390	148
3"	24	21	500	87.5
4"	73	41	1350	413.5

### Allowable Loads for Stud Bolt Assembly Conditions

Mounting stud bolts, in different versions and locations, are available on the BPHEs as an option. These stud bolts are welded to the unit. The maximum allowable load on the stud bolts during assembly are stated below.

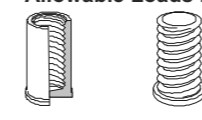

Allowable loads for different stud bolt assembly conditions

Stud Bolt	Diameter, dk (mm)	Tension Force, Ft (N)	Torque, Mt (Nm)
M6	5.1	1500	3
M8	6.9	2700	7
M12	10.3	6000	18

### STRAINERS

If any of the media contains particles larger than 1 mm (0.04 inch), we recommend that a strainer with a size of 16-20 mesh (number of openings per inch) is installed before the exchanger. The particles could otherwise block the channels, causing bad performance, increased pressure drop and risk of freezing.



### INSULATIONS

#### Insulation for Refrigerant Applications

BPHE insulation is recommended for evaporators, condensers or district heating applications, etc. For refrigeration, use extruded insulation sheets, e.g. Armaflex or equivalent which also can be supplied by SWEP.

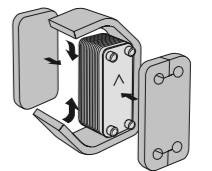

#### Insulation for Heating Applications

For heating applications, various types of insulation boxes can be used. The working temperature range defines which insulation is recommended. SWEP can supply some of these insulation types as optional accessories.

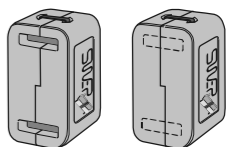

### INSTALLATION OF BPHEs IN DIFFERENT APPLICATIONS

#### Single-Phase Applications

Normally, the circuit with the highest temperature and/or pressure should be connected on the left side of the heat exchanger when the arrow is pointing upwards. For example, in a typical water-to-water application, the two fluids are connected in a counter-current flow, i.e. the hot water inlet in connection F1, outlet F3, cold water inlet F4, outlet F2. This is because the right-hand side of the heat exchanger contains one channel more than the left-hand side, and the hot medium is thus surrounded by the cold medium to prevent heat loss.

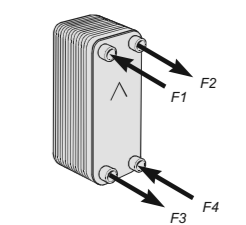

#### Two-Phase Applications

In all refrigerant applications it is very important that every refrigerant channel is surrounded by a water/brine channel on both sides. Normally the refrigerant side must be connected to the left-hand side and the water/brine circuit to the right-hand side of the BPHE. If the refrigerant is incorrectly connected, to the first and last channel instead of water/brine, the evaporation temperature will drop, with the risk of freezing and very bad performance. SWEP BPHEs used as condensers or evaporators should always be fitted with adequate connections on the refrigerant side.

#### Evaporators; Three evaporator types (V, P, S)

The V-type BPHEs are equipped with a special distribution device at the refrigerant inlet, i.e. normally port F3. The purpose of the distribution device is to evenly distribute the refrigerant in the channel.

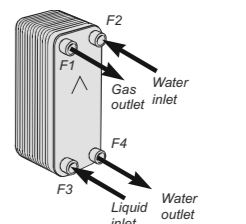

The refrigerant liquid should be connected to the lower left connection (F3) and the refrigerant gas outlet to the upper left connection (F1). The water/brine circuit inlet should be connected to the upper right connection (F2) and the outlet to the lower right connection (F4).

#### Expansion Valves

The expansion valve should be placed close to the inlet connection, whereas the bulb should be mounted about 500 mm from the vaporized refrigerant outlet connection. The pipe diameter between the expansion valve and the BPHE should be the same as the diameter of the refrigerant liquid line.

For the evaporators, the pressure drop in the internal distribution system must be added to the pressure drop in the expansion valve to arrive at the total pressure drop. Normally, selecting the next larger size valve will give satisfactory performance.